

# MISCELLANEOUS HARDWARE & ACCESSORIES

**SWITCH HARDWARE.....V2**  
**PUSHBUTTON AND TOGGLE CAPS.....V2 - V3**  
**SECURITY GUARDS.....V3**

SPECIFICATIONS SUBJECT TO CHANGE WITHOUT NOTICE



## MISCELLANEOUS HARDWARE

**HEX NUT A112** Nickel plated brass  
1/4-40

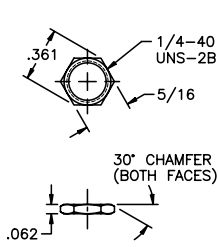

**HEX NUT A465**  
Nickel plated brass 15/32-32

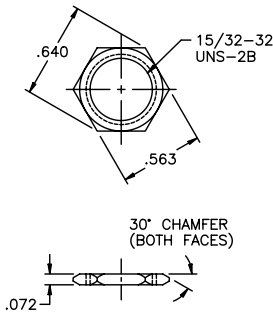

**PANEL DRESS NUT A168P1**  
Blind thread, Nickel plated brass  
1/4-40

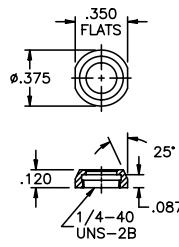

**PANEL DRESS NUT A168P2**  
Thru thread, Nickel plated brass  
1/4-40

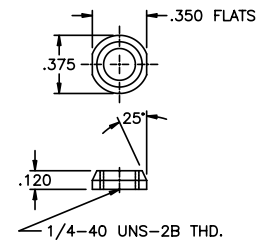

**PANEL DRESS NUT A274**  
Nickel plated brass 1/4-40

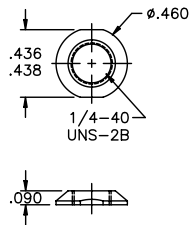

**PANEL DRESS NUT A540**  
Nickel plated brass 15/32-32

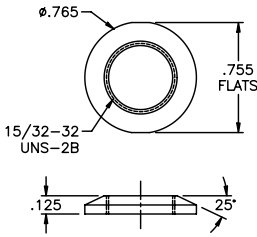

**DECORATIVE NUT A447**  
Thru thread, chromium plated brass  
1/4-40

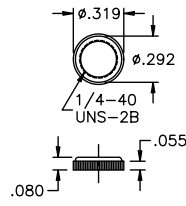

**ANTI-ROTATE RING (LARGE) A158**  
Nickel plated brass 1/4

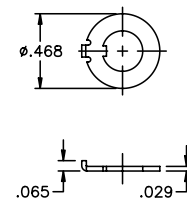

**ANTI-ROTATE RING A482**  
Nickel plated brass 15/32

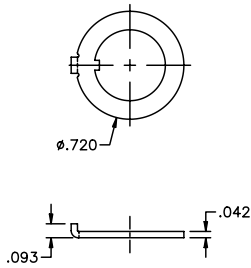

**LOCKWASHER A115**  
Nickel plated steel 1/4

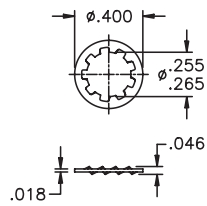

**LOCKWASHER A466**  
Nickel plated steel 15/32

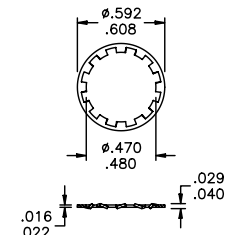

**ANTI-ROTATE RING A107**  
Nickel plated brass 1/4

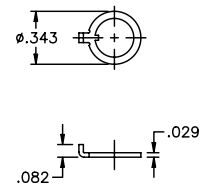

**PUSHBUTTON CAPS (ALL)**

Material - Nylon

Caps press fit adequately, however they may be pulled off. If permanent retention is required, cement with Loctite 405 or equivalent, insuring no cement enters switch.

**PUSHBUTTON CAP A212**

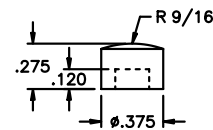

**FITS PB SERIES**

**COLOR CAPS B366 & B497**

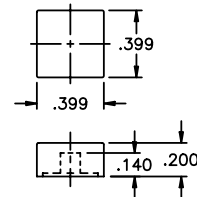

**B366** fits 300 & 400 Series with S option only, and all PB Series.

**B497** fits 800 Series with options KM, KS, KM1, K1M1 & K2M1.

**PUSHBUTTON CAPS A180 & A496**

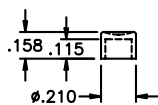

**A180** fits all PB Series.

**A496** fits 800 Series with options KM, KS, KM1, K1M1, K2M, K2S & K2M1.

**PUSHBUTTON CAP A235**

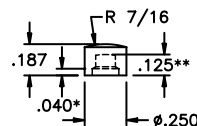

\* - fits all PB, 300 & 400 Series.

\*\* - fits 800 Series with options KM, KS, KM1 & K2M1.

**STANDARD COLOR CODE**

For nylon caps, actuators, bezels & bezel inserts.  
To specify, add selected color code to part number. Example: A2122 is a black A212 Cap. To specify for actuators, bezels and bezel inserts, see 'Order Format' section following specific series information in this catalog.

Code	Color	Code	Color
1	blue	2	black
3	green	4	gray
5	yellow	6	red
7	ivory	8	white
9	orange		

SPECIFICATIONS SUBJECT TO CHANGE WITHOUT NOTICE

## MISCELLANEOUS HARDWARE (CONT'D.)

### PUSHBUTTON CAP A420

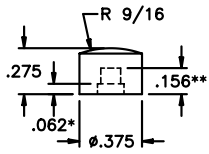

\* - Fits all 300 Series except 301 & 305. Fits 301 & 305 with S option. Fits all 400 & PB Series.  
 \*\* - Fits 800 Series with options KM, KS, KM1 & K2M1.

### COLOR CAP B494

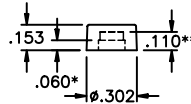

\*\* - P1 fits all 800 Series except K1M & K1S.  
 \* - P2 fits all 300 & 400 Series.  
 \* - P3 fits all PB Series.

### PUSHBUTTON CAP A631

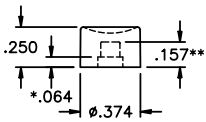

\* - Fits all 300 Series except 301 & 305. Fits 301 & 305 with S option. Fits all 400 & PB Series.  
 \*\* - Fits 800 Series with options KM, KS, KM1 & K2M1.

### PUSHBUTTON CAP A632

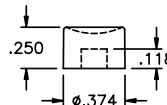

Fits all PB Series.

## CUSTOM MARKING

Permanent ink marking is available for switch caps, bezels and rocker actuators. Consult factory with your special requirement. Representative samples available.

## SWITCH GUARDS

Materials: 5056-H18 aluminum with clear or black anodize, or free machining brass with bright chrome plate.  
 Dimensions in inches and (millimeters). Tolerances: A & D, ±.015" B & C, ±.005"

MODEL	TH'D.	COLOR	FINISH	A	B	C	D
MG11A	10-48	NATURAL AL.	PLAIN				
MG11B	10-48	BLACK AL.	PLAIN				
MG12A	1/4-40	NATURAL AL.	PLAIN				
MG12B	1/4-40	BLACK AL.	PLAIN	.530 (13.5)	.413 (10.5)	.315 (8.0)	.236 (6.0)
MG12C	1/4-40	CHROMED BR.	PLAIN				
MG12KA	1/4-40	NATURAL AL.	KNURLED				
MG12KB	1/4-40	BLACK AL.	KNURLED				
MG12KC	1/4-40	CHROMED BR.	KNURLED				
MG13A	1/4-40	NATURAL AL.	PLAIN				
MG13B	1/4-40	BLACK AL.	PLAIN	.730 (18.5)	.610 (15.5)	.315 (8.0)	.236 (6.0)
MG13C	1/4-40	CHROMED BR.	PLAIN				

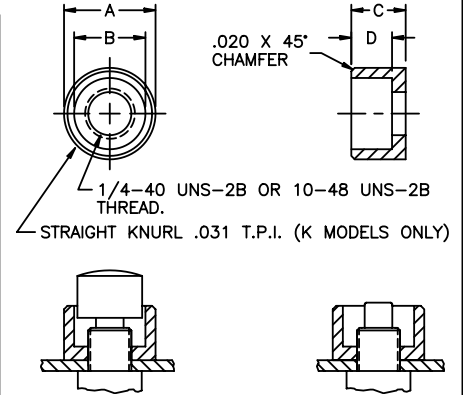

### STANDARD COLOR CODE

For nylon caps, actuators, bezels & bezel inserts.  
 To specify, add selected color code to part number. Example: A2122 is a black A212 Cap. To specify for actuators, bezels and bezel inserts, see 'Order Format' section following specific series information in this catalog.

Code	Color	Code	Color
1	blue	2	black
3	green	4	gray
5	yellow	6	red
7	ivory	8	white
9	orange		

SPECIFICATIONS SUBJECT TO CHANGE WITHOUT NOTICE

V