

Hardware

For miniature switches

- Standard hardware is automatically supplied with the switches
- Non standard hardware is to be ordered separately



Hardware supplied with sealing options :

- K version : 2 hex nuts + sealing washer
- X408 option : 1 hex nut + 1 O-ring

STANDARD HARDWARE FOR SWITCHES Ø 6 (.236) - 5000 SERIES

HEX NUT

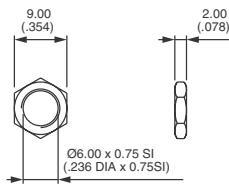

Nickel plated **U208**
Matt black **U726**

LOCKING RING

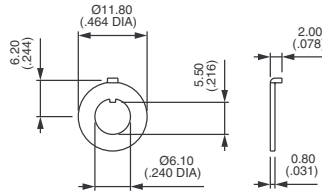

Nickel plated **U198**
Matt black **U728**

LOCKWASHER

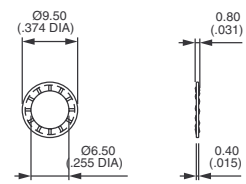

Stainless steel **U215**

NON STANDARD HARDWARE FOR SWITCHES Ø 6 (.236) - 5000 SERIES

KNURLED NUT

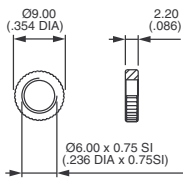

Chrome plated **U826**

SPECIAL NUT 12 (.472) ACROSS FLATS

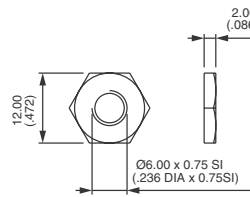

Chrome plated **U1916**

KNURLED CAP NUTS

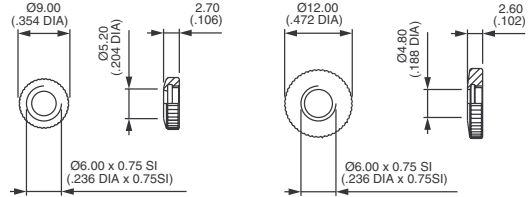

Chrome plated **U461**
Matt black **U502**

Chrome plated **U232**

STANDARD HARDWARE FOR SWITCHES Ø 6,35 (1/4) - ALL SERIES

HEX NUT

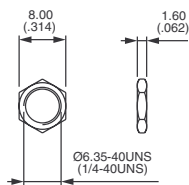

Nickel plated **U76**
Matt black **U94**

LOCKING RING

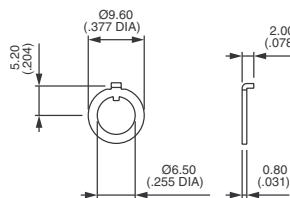

Nickel plated **U78**
Matt black **U93**

LOCKWASHER

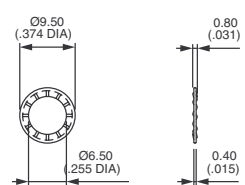

Stainless steel **U215**

HARDWARE SUPPLIED (unsealed types)

SERIES	HEX NUT	LOCKING RING	LOCKWASHER
SF	2	1	1
11000	2	1	1
13000	2	1	1
18000-8000-SP	2	1	1
21000N	2	-	-
5000	2	1	1
9400-9600	2	-	1

Hardware

For miniature switches

NON STANDARD HARDWARE FOR SWITCHES Ø 6,35 (1/4) - ALL SERIES

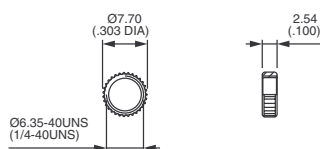
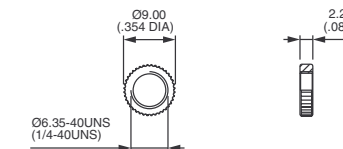
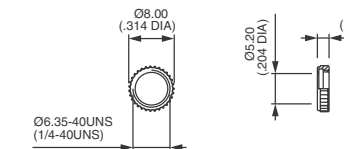
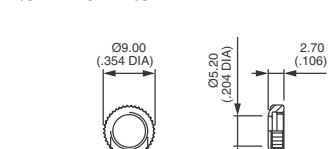
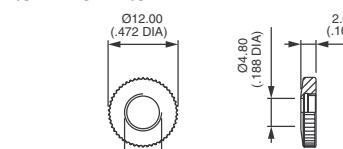
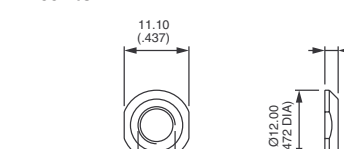
<p>KNURLED NUT</p>  <p>Nickel plated U369</p>	<p>KNURLED NUT</p>  <p>Nickel plated U229 Matt black U230</p>	<p>KNURLED NUT</p>  <p>Chrome plated U501</p>
<p>KNURLED CAP NUT</p>  <p>Chrome plated U216 Matt black U218</p>	<p>KNURLED CAP NUT</p>  <p>Chrome plated U268 Matt black U725</p>	<p>DRESS NUT</p>  <p>Nickel plated U443 Matt black U848</p>

* U216 and U268 : consult factory for mounting on 11000 three and four pole, and 5000 locking lever models.

OTHER HARDWARE FOR SWITCHES Ø 6,35 (1/4) - ALL SERIES

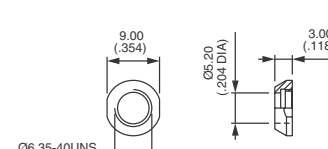
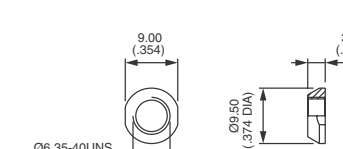
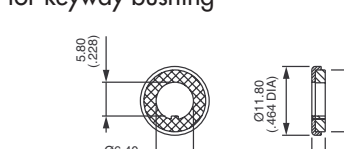
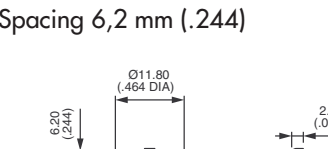
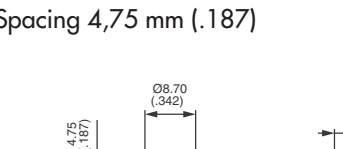
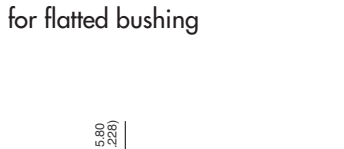
<p>CONIC CAP NUT</p>  <p>Nickel plated U500</p>	<p>CONIC NUT</p>  <p>Chrome plated U542 Nickel plated U561</p>	<p>SEALING WASHER for keyway bushing</p>  <p>U360</p>
<p>SPECIAL LOCKING RING Spacing 6,2 mm (.244)</p>  <p>Nickel plated U368</p>	<p>SPECIAL LOCKING RING Spacing 4,75 mm (.187)</p>  <p>Nickel plated U409</p>	<p>SEALING WASHER for flatted bushing</p>  <p>U5141</p>

Hardware

For miniature switches

STANDARD HARDWARE FOR SWITCHES Ø 10 (.393) - 10400 AND 10600 SERIES

**KNURLED CAP NUT
(std for 10600)**

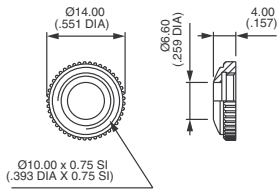

Chrome plated
U2220

**KNURLED NUT
(std for 10400)**

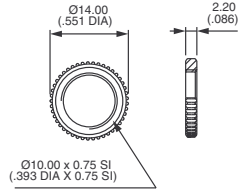

Chrome plated
U2311

HEX NUT

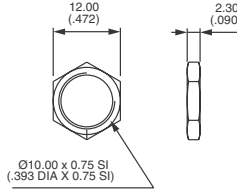

Nickel plated
U842

LOCKING RING

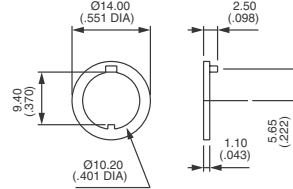

Nickel plated
U844

LOCKWASHER

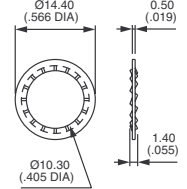

Stainless steel
U843

STANDARD HARDWARE FOR SWITCHES Ø 11,9 (15/32) - 12000, 13000X768 AND 5600M SERIES

HEX NUT

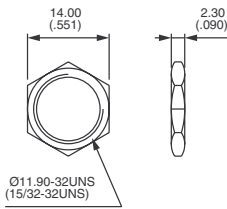

Nickel plated
Matt black
U162
U41

LOCKING RING

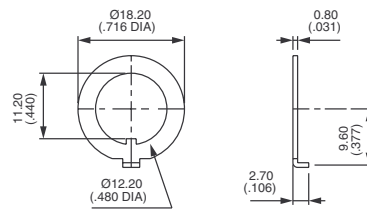

Nickel plated
Matt black
U121
U12

SERIES	HARDWARE SUPPLIED	
	HEX NUT	LOCKING RING
12000	2	1
13000X768	1	-
5600M	2	1
8000X718	2	1

NON STANDARD HARDWARE FOR SWITCHES Ø 11,9 (15/32) - 12000, 13000X768 AND 5600M SERIES

KNURLED NUT

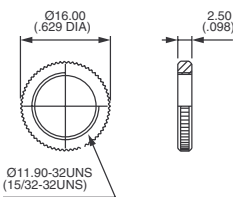

Nickel plated
Matt black
U53
U1634

KNURLED CAP NUTS

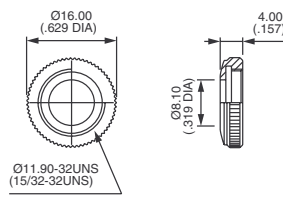

Chrome plated
U124

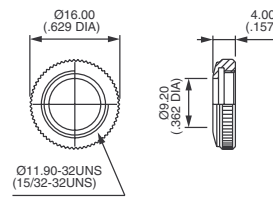

Chrome plated
U123

LOCKWASHER

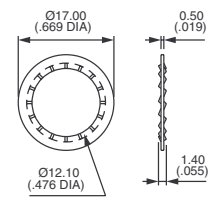

Zinc plated
U13

OTHER HARDWARE

SEALING WASHER

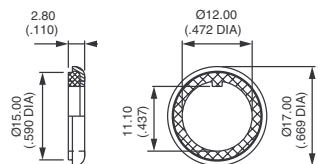

U60

WRENCHES



Wrenches are available for some accessories. Consult factory.

Hardware

For industrial switches

- Standard hardware is indicated by darkened boxes.
- For details of hardware supplied, please refer to beginning of each series.
- Special hardware is to be ordered separately.



Hardware supplied with **K** sealing option : 2 hex nuts.

NUTS	Bushing Ø 11,9 (15/32) thread 0,794-32UNS Series 3500 - 6000			Bushing Ø 12 (.472) thread 0,75 Series IB/IS - IP - 660 - 600H - 600NH 1000 - 1200 - 1500 - 1600 - 1700 - 3600 - 4000		
	Chrome plated brass	Nickel plated brass	Matt black brass	Chrome plated brass	Nickel plated brass	Matt black brass
		U53		U412	U411	U413
	U92	U162	U41	U212	U166	U183
 Hex cap nut				U35		
 PAL nut					U42 (passive zinc plated steel)	
 Knurled cap nut	U123			U117 $\alpha = 8,5 (.334)$ U118 $\alpha = 10,3 (.405)$		U129 $\alpha = 8,5 (.334)$ U130 $\alpha = 10,3 (.405)$

INSULATED NUT U520

 ABS or polyamide with glass fibre	For threaded bushing Ø 12 (.472) x 0,75 IS Series 1500 - 4000 - 600NH - 6-600NH								
	Blue	Black	Green	Grey	Yellow	Red	White	Chrome plated	Orange
	U521	U522	U523	U524	U525	U526	U527/1	U528	U529

The locking ring U121 (nickel plated) or U12 (matt black) is only provided with tropicalized switches version T or G and with series 3500 - 6000.

The lockwasher U13 must be ordered separately, except for series 660, 3500 and 6000.

Hardware

For industrial switches

HARDWARE FOR SWITCHES Ø 12 (.472) AND 11,9 (15/32)

LOCKING RING

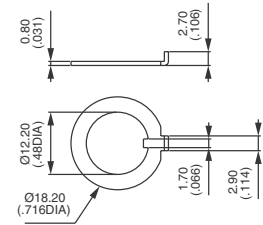

Nickel plated **U121**
Matt black **U12**

LOCKWASHER

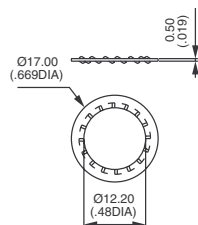

Zinc plated **U13**

SEALING WASHER

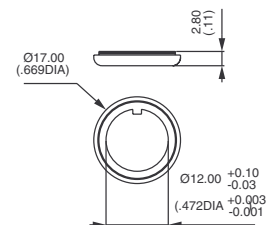

Stainless steel and neoprene **U60**

SEALING WASHER FOR BOOTS

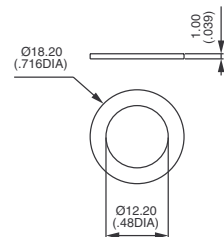

Nylon **U21**

GROUND CONNECTOR

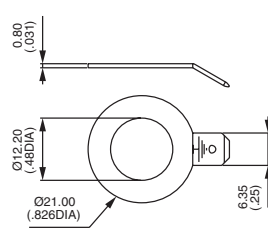

Nickel plated **U187**

LOCKWASHER

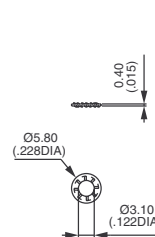

U14

PLATES FOR SWITCHES Ø 12 (.472) AND 11,9 (15/32)

Marche - arrêt

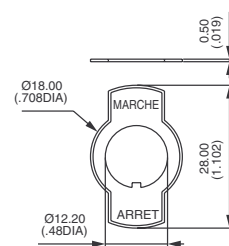

U17

ON - OFF

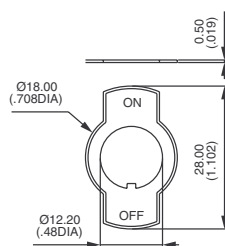

U19

EIN - AUS

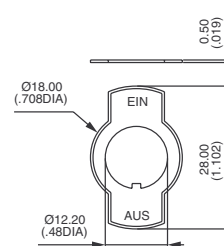

U99

I - 0

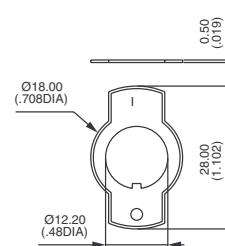

U1050

SCREWS (supplied with the switches)

CONNECTING SCREW

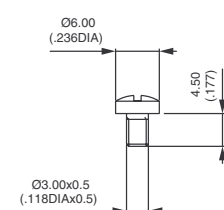

U03

MOUNTING SCREW Ø 3 (.118) (6000 SERIES)

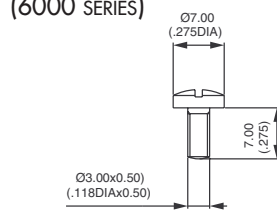

Nickel plated **U164**
Chrome plated **U165**
Matt black **U45**

Hardware

For industrial switches

HARDWARE FOR AV SERIES (ANTI-VANDAL AND SECURITY PUSHBUTTON SWITCHES)

HEX NUT FOR MODELS Ø 16 (.629)

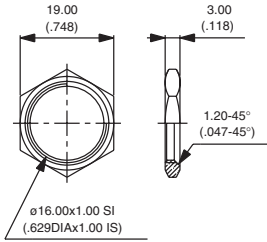

10-621 (sealed or unsealed models)

KNURLED NUT FOR MODELS Ø 16 (.629)

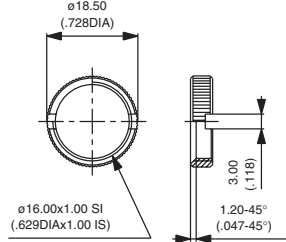

10-960-5 (sealed or unsealed models)

KNURLED NUT FOR MODELS Ø 19 (.748)

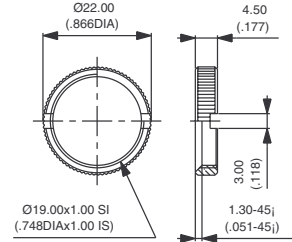

U1977-5 (sealed or unsealed models)

HEX NUTS FOR MODELS Ø 19 (.748)

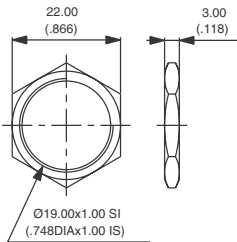

U1950-5 (unsealed models)

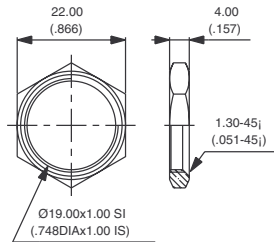

10-855-5 (sealed models)

Wrench for nut U1977-5 available under part number U1929.

HEX NUTS FOR MODELS Ø 22 (.866)

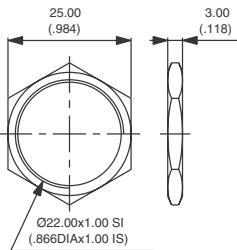

U1951-5 (unsealed models)

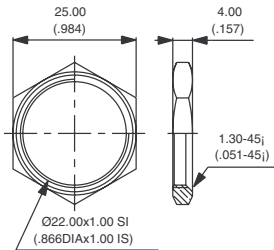

10-856-5 (sealed models)

HEX NUT FOR MODELS Ø 24 (.944)

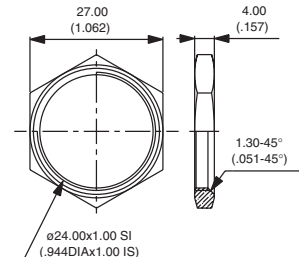

U2059-5 (sealed or unsealed models)

All above nuts are made of nickel plated brass.

For switches with front panel sealing (option K), a neoprene O-ring is supplied with each nut.