

**Full - Bridge
Fast Trench + Field Stop IGBT®
Power Module**

**$V_{CES} = 1200V$
 $I_C = 100A @ T_c = 80^\circ C$**

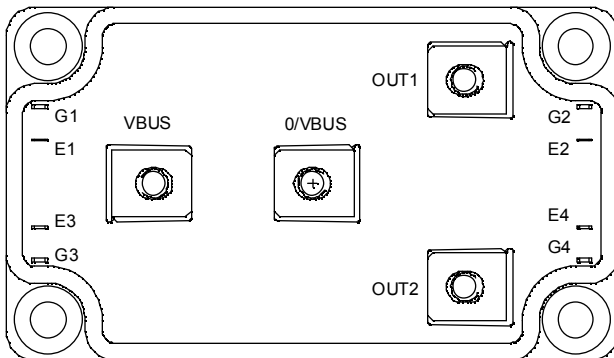
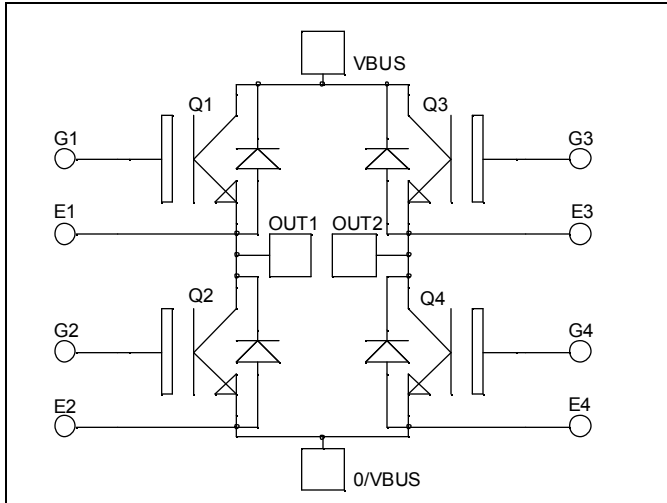

Application

- Welding converters
- Switched Mode Power Supplies
- Uninterruptible Power Supplies
- Motor control

Features

- Fast Trench + Field Stop IGBT® Technology
 - Low voltage drop
 - Low tail current
 - Switching frequency up to 20 kHz
 - Soft recovery parallel diodes
 - Low diode VF
 - Low leakage current
 - Avalanche energy rated
 - RBSOA and SCSOA rated
- Kelvin emitter for easy drive
- Very low stray inductance
 - Symmetrical design
 - M5 power connectors
- High level of integration

Benefits

- Stable temperature behavior
- Very rugged
- Direct mounting to heatsink (isolated package)
- Low junction to case thermal resistance
- Easy paralleling due to positive TC of VCEsat
- Low profile
- RoHS Compliant

Absolute maximum ratings

Symbol	Parameter	Max ratings	Unit
V_{CES}	Collector - Emitter Breakdown Voltage	1200	V
I_C	Continuous Collector Current	$T_C = 25^\circ C$	140
		$T_C = 80^\circ C$	100
I_{CM}	Pulsed Collector Current	$T_C = 25^\circ C$	200
V_{GE}	Gate - Emitter Voltage	± 20	V
P_D	Maximum Power Dissipation	$T_C = 25^\circ C$	480
RBSOA	Reverse Bias Safe Operating Area	$T_j = 125^\circ C$	200A @ 1100V

 **CAUTION:** These Devices are sensitive to Electrostatic Discharge. Proper Handling Procedures Should Be Followed. See application note APT0502 on www.microsemi.com

All ratings @ $T_j = 25^\circ\text{C}$ unless otherwise specified

Electrical Characteristics

Symbol	Characteristic	Test Conditions	Min	Typ	Max	Unit
I_{CES}	Zero Gate Voltage Collector Current	$V_{GE} = 0\text{V}, V_{CE} = 1200\text{V}$			250	μA
$V_{CE(sat)}$	Collector Emitter Saturation Voltage	$V_{GE} = 15\text{V}$ $I_C = 100\text{A}$	$T_j = 25^\circ\text{C}$ $T_j = 125^\circ\text{C}$	1.4 2.0	1.7 2.1	V
$V_{GE(th)}$	Gate Threshold Voltage	$V_{GE} = V_{CE}, I_C = 2\text{mA}$	5.0	5.8	6.5	V
I_{GES}	Gate – Emitter Leakage Current	$V_{GE} = 20\text{V}, V_{CE} = 0\text{V}$			400	nA

Dynamic Characteristics

Symbol	Characteristic	Test Conditions	Min	Typ	Max	Unit
C_{ies}	Input Capacitance	$V_{GE} = 0\text{V}$		7200		pF
C_{oes}	Output Capacitance	$V_{CE} = 25\text{V}$		400		
C_{res}	Reverse Transfer Capacitance	$f = 1\text{MHz}$		300		
$T_{d(on)}$	Turn-on Delay Time	Inductive Switching (25°C) $V_{GE} = \pm 15\text{V}$ $V_{Bus} = 600\text{V}$ $I_C = 100\text{A}$ $R_G = 3.9\Omega$		260		ns
T_r	Rise Time			30		
$T_{d(off)}$	Turn-off Delay Time			420		
T_f	Fall Time			70		
$T_{d(on)}$	Turn-on Delay Time	Inductive Switching (125°C) $V_{GE} = \pm 15\text{V}$ $V_{Bus} = 600\text{V}$ $I_C = 100\text{A}$ $R_G = 3.9\Omega$		290		ns
T_r	Rise Time			50		
$T_{d(off)}$	Turn-off Delay Time			520		
T_f	Fall Time			90		
E_{on}	Turn on Energy	$V_{GE} = \pm 15\text{V}$ $V_{Bus} = 600\text{V}$ $I_C = 100\text{A}$ $R_G = 3.9\Omega$	$T_j = 125^\circ\text{C}$	10		mJ
E_{off}	Turn off Energy		$T_j = 125^\circ\text{C}$	10		

Reverse diode ratings and characteristics

Symbol	Characteristic	Test Conditions	Min	Typ	Max	Unit
V_{RRM}	Maximum Peak Repetitive Reverse Voltage		1200			V
I_{RM}	Maximum Reverse Leakage Current	$V_R = 1200\text{V}$			$T_j = 25^\circ\text{C}$ $T_j = 125^\circ\text{C}$	μA
I_F	DC Forward Current			100		A
V_F	Diode Forward Voltage	$I_F = 100\text{A}$ $V_{GE} = 0\text{V}$		$T_j = 25^\circ\text{C}$ $T_j = 125^\circ\text{C}$	1.6 2.1	V
t_{rr}	Reverse Recovery Time	$I_F = 100\text{A}$ $V_R = 600\text{V}$ $di/dt = 2000\text{A}/\mu\text{s}$		$T_j = 25^\circ\text{C}$ $T_j = 125^\circ\text{C}$	170 280	ns
Q_{rr}	Reverse Recovery Charge			$T_j = 25^\circ\text{C}$ $T_j = 125^\circ\text{C}$	9 18	μC
E_r	Reverse Recovery Energy			$T_j = 25^\circ\text{C}$ $T_j = 125^\circ\text{C}$	5 9	mJ

Thermal and package characteristics

Symbol Characteristic

			Min	Typ	Max	Unit
R _{thJC}	Junction to Case Thermal Resistance	IGBT			0.26	°C/W
		Diode			0.48	
V _{ISOL}	RMS Isolation Voltage, any terminal to case t=1 min, I _{isol} <1mA, 50/60Hz		2500			V
T _J	Operating junction temperature range		-40		150	°C
T _{STG}	Storage Temperature Range		-40		125	
T _C	Operating Case Temperature		-40		100	
Torque	Mounting torque	To heatsink	M6	3	5	N.m
		For terminals	M5	2	3.5	
Wt	Package Weight				280	g

SP6 Package outline (dimensions in mm)

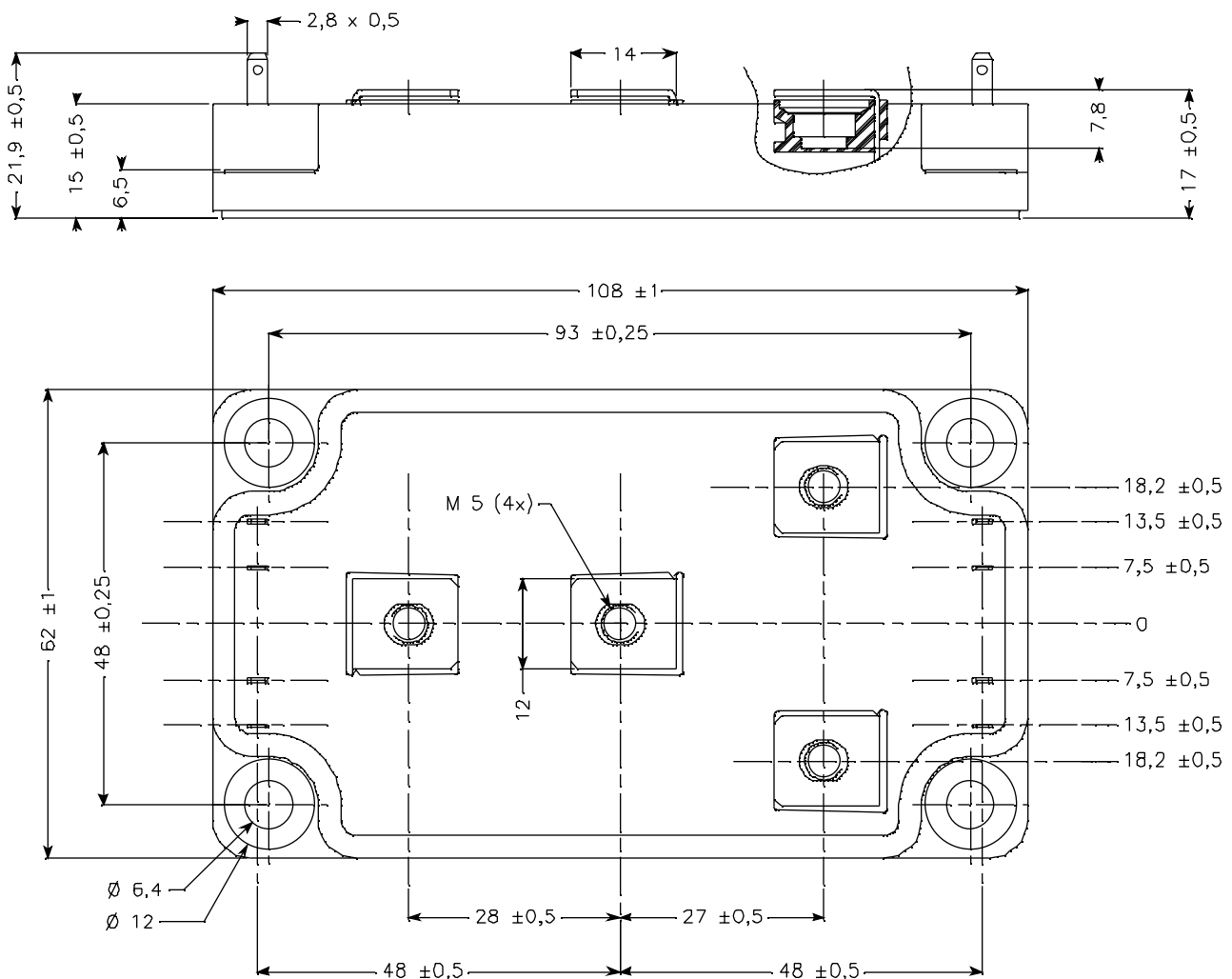

See application note APT0601 - Mounting Instructions for SP6 Power Modules on www.microsemi.com

Typical Performance Curve

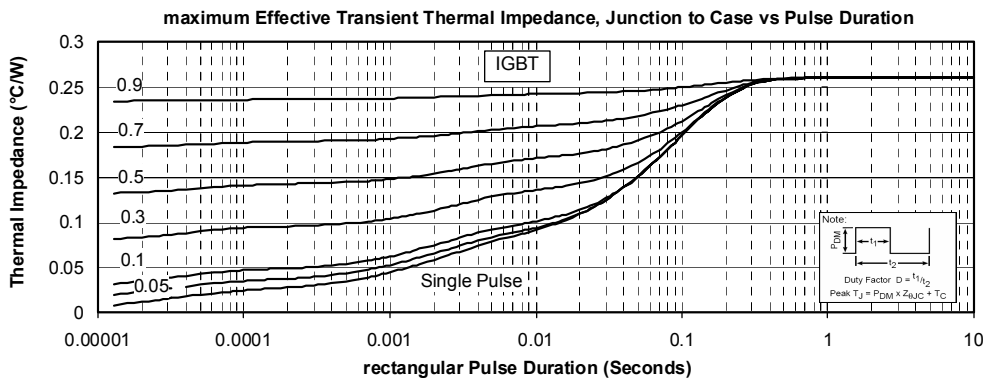
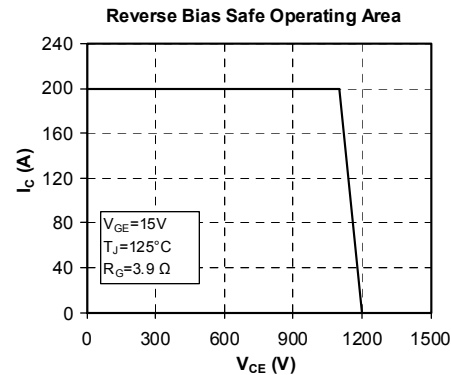
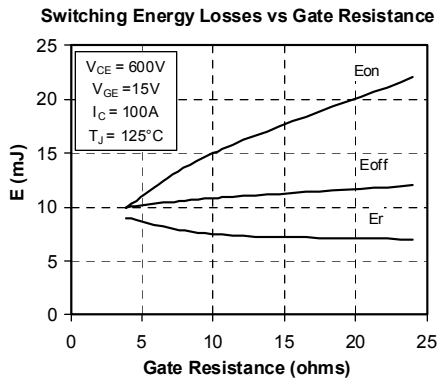
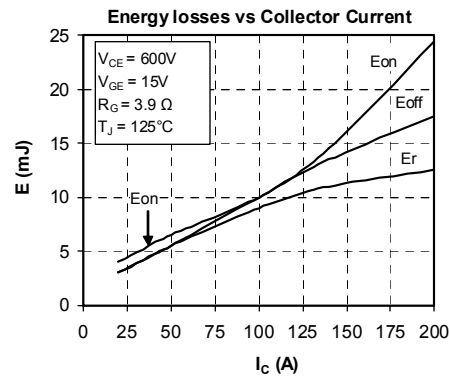
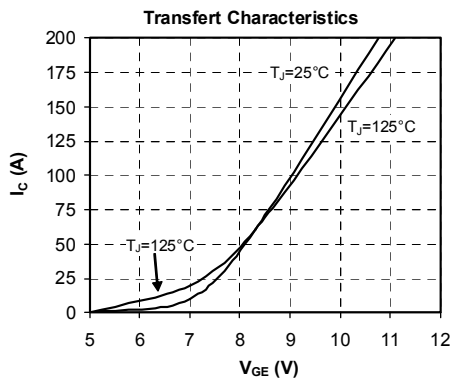
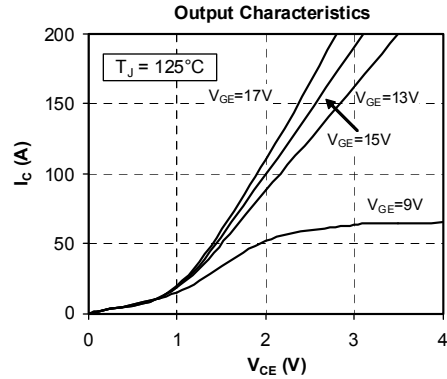
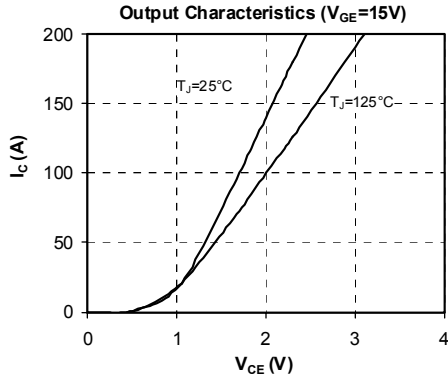

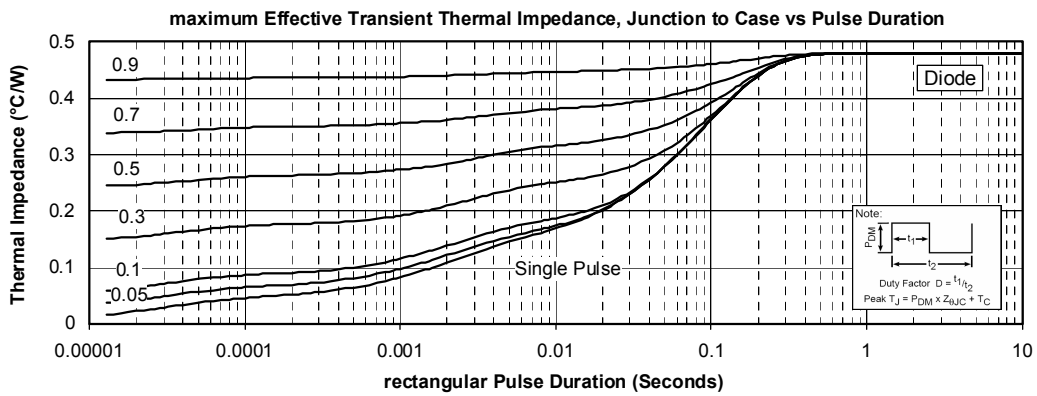
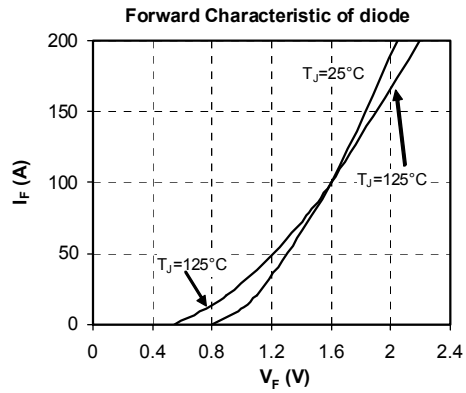
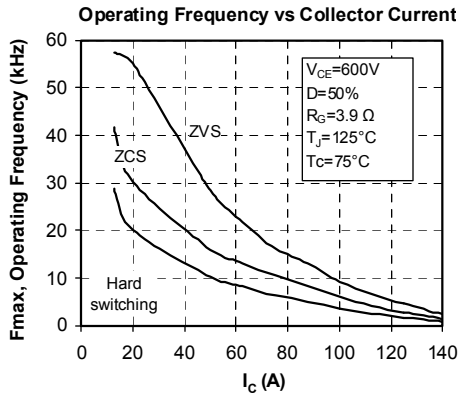

Microsemi reserves the right to change, without notice, the specifications and information contained herein

Microsemi's products are covered by one or more of U.S. patents 4,895,810 5,045,903 5,089,434 5,182,234 5,019,522 5,262,336 6,503,786 5,256,583 4,748,103 5,283,202 5,231,474 5,434,095 5,528,058 and foreign patents. U.S. and Foreign patents pending. All Rights Reserved.