

Four-channel Pressure Sensor Offers Versatile Functions and High Precision Without Errors

- The industry's smallest pressure sensor, compact, lightweight — ideal for robot arms or other moving components
- A highly sensitive minute-pressure sensor model detects very small differences in air pressure
- Requires no wiring conduit — can be located for sensing in small places
- Simple display panel efficiently saves space, but offers large LEDs
- Easy sensitivity adjustment using the teach function and channel-to-channel copy function



Ordering Information

■ SENSORS

E8MS

Type	Pressure range description	Part number
Positive pressure sensor	0 to 100 kPa (0 to 14.5 psi)	E8MS-01
	0 to 1 MPa (0 to 145 psi)	E8MS-10
Negative pressure sensor	0 to -101 kPa (0 to -14.6 psi)	E8MS-N0

E8M

Type	Pressure range description	Part number
Minute differential pressure sensor	Differential pressure from 0 to 1,000 Pa (0 to 0.145 psi) between positive and negative ports	E8M-A1
Positive pressure sensor	0 to 1 MPa (0 to 145 psi)	E8M-10
Negative pressure sensor	0 to -101 kPa (0 to -14.6 psi)	E8M-N0

■ CONTROLLER

Item	Description	Part number
Controller	Optional for pressure sensors: E8M series and E8MS series	K3C-MP8-T1Z

■ ACCESSORIES (ORDER SEPARATELY)

Item	Description	Part number
Sensor connector cable	4-pin connector with 3-m cable <i>required</i> for E8M-10 and E8M-N0 (Note: E8M-A1 does not require this cable.)	E89-M3
	3-pin connector with 3-m cable <i>required</i> for E8MS-01, E8MS-10 and E8MS-N0	E89-M4
Cable connector	Replacement cable connector for the E89-M3 and E89-M4 Sensor connector cables. (Note: This connector is provided with the E89-M3 and E89-M4 cables. As a replacement connector, it can be purchased separately.)	XS8A-0442
Connector cable for K3C controller	7-pin connector with 2-m cable <i>required</i> for K3C controller	K32-MP2W
Soft cover	Clear rubber cover for K3C controller	Y92A-48F1
Hard cover	Clear plastic cover for K3C controller	Y92A-48

Specifications

■ RATINGS/CHARACTERISTICS

Sensors

E8MS

Item	E8MS-01	E8MS-10	E8MS-N0
Power supply voltage	12 VDC \pm 10%, ripple (p-p) of 5% max.		
Current consumption	25 mA max.		
Pressure type	Gauge pressure		
Applicable fluid	Non-corrosive gas and non-flammable gas		
Rated pressure range	0 to 100 kPa (0 to 14.5 psi)	0 to 1 MPa (0 to 145 psi)	0 to -101 kPa (0 to -14.6 psi)
Withstand pressure	400 kPa (58 psi)	1.5 MPa (217.5 psi)	400 kPa (58 psi)
Linearity	\pm 1% FS max.		
Hysteresis	\pm 1% FS max.		
Output (linear output)	Voltage output: 1 to 5 V with an output impedance of 1 k Ω		
Protection circuit	Reverse polarity connection, load short-circuiting		
Ambient temperature	Operating	0°C to 50°C (32°F to 122°F)	
	Storage	-15° to 60°C with no icing (5°F to 140°F)	
Ambient humidity	35 to 85% with no condensation		
Temperature influence	\pm 0.12% FS/°C max.		
Voltage influence	\pm 1% FS max.		
Insulation resistance	100 M Ω min. (500 VDC) between current-carry parts and case		
Dielectric strength	1,000 VAC 1 min		
Vibration resistance	10 to 150 Hz, 0.35-mm single amplitude or 50 m/s ² (approx. 5G) for 8 min for 10 times each in X, Y, and Z directions		
Shock resistance	500 m/s ² (approx. 50G) for 3 times each in X, Y, and Z directions.		
Enclosure rating	IEC60529 IP50		
Pressure joint	1/8 NPT and M5 female screw		
Connection method	Connector (use the E89-M4, sold separately)		
Weight (packaged weight)	Approx. 6 g (0.21 oz.)		
Material	Pressure joint: Aluminum		
Accessories	Instruction manual		

E8M

Item	E8M-A1	E8M-10	E8M-N0
Power Supply voltage	12 VDC \pm 10%, ripple (p-p) of 5% max.		
Current consumption	30 mA max.		
Pressure type	Differential pressure	Gauge pressure	
Applicable fluid	Non-corrosive gas and non-flammable gas		
Rated pressure range	Differential pressure from 0 to 1,000 Pa (0 to 0.145 psi) between positive and negative ports	0 to 1 MPa (0 to 145 psi)	0 to -101 kPa (0 to -14.6 psi)
Withstand pressure	Differential pressure from 0 to 2,500 Pa (0 to 0.36 psi) between positive and negative ports (see note)	1.5 MPa (217.5 psi)	400 kPa (58 psi)
Accuracy	\pm 3% FS max.	\pm 5% FS max.	
Linearity	\pm 1% FS max.		
Hysteresis	\pm 1% FS max.		
Output (linear output)	Voltage output: 1 to 5 V with an output impedance of 1 k Ω		
Protection circuit	Reverse polarity connection, load short-circuiting		
Ambient temperature	Operating	0°C to 40°C (32°F to 104°F)	
	Storage	-15° to 50°C with no icing (5°F to 122°F)	
Ambient humidity	35 to 85% with no condensation		
Temperature influence	\pm 0.25% FS/°C max.	\pm 0.12% FS/°C max.	
Voltage influence	\pm 3% FS max.		
Insulation resistance	100 M Ω min. at 500 VDC between current-carry parts and case		
Dielectric strength	1,000 VAC 1 min		
Vibration resistance	10 to 150 Hz, 0.75-mm single amplitude or 100 m/s ² (approx.10G) for 8 min for 4 times each in X, Y, and Z directions		
Shock resistance	300 m/s ² (approx. 30G) for 3 times each in X, Y, and Z directions.		
Enclosure rating	IEC60529 IP50		
Pressure joint	M5 female screw	1/8 NPT and M5 female screw	M5 male screw
Connection method	4 mm (0.16 in.) dia. 4 conductor, vinyl-insulated cord; standard length: 3m (9.84 ft.)	Connector (use the E89-M3, sold separately)	
Weight (packaged weight)	Approx. 130 g (4.59 oz.)	Approx. 30 g (1.06 oz.)	Approx. 20 g (0.71 oz.)
Material	Pressure joint	SUS303	
	Case	ABS	
Accessories	Pin Controller Connector, instruction manual	Instruction manual	

Note: The absolute pressure value of each port is 100 kPa. (14.5 psi)

Measurement method

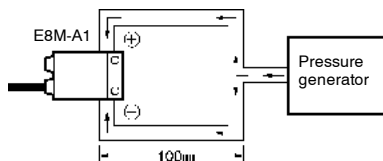

Controllers

Item		K3C-MP8-T1Z			
Connectable Pressure Sensor		E8M-A1 Differential pressure from 0 to 1,000 Pa (0 to 0.145 psi) between positive and negative ports	E8MS-01 0 to 100 kPa (0 to 14.5 psi)	E8MS-10 E8M-10 0 to 1 MPa (0 to 145 psi)	E8MS-N0, E8M-N0 0 to -101 kPa (0 to -14.6 psi)
Power Supply voltage		24 VDC \pm 10%, ripple (p-p) 10% max.			
Current consumption		200 mA max.			
Sensor power supply		Supplied from the Controller, 12 VDC \pm 10% (120 mA max. for the total channels used)			
Input	Sensor input (through 4-pin one-touch connector)	Input voltage range: 1 to 5 VDC with an impedance of 1 M Ω per channel			
Output	Comparative output	NPN open collector Flow current: 30 mA max. Applied voltage: 30 VDC max. Residual voltage: 0.8 V max. with a flow current of 30 mA 0.4 V max. with a flow current of 16 mA NO or NC (selectable) independent output in hysteresis or wind comparator mode (selectable) on each channel			
Indicators	Measurement value	LED indicator (red) with a character height of 10.8 mm for 3 ¹ / ₂ digits for a single channel selected.			
	Message	LED indicator (red) with a character height of 10.8 mm for 3 ¹ / ₂ digits.			
	Measurement and setting channel	LED indicator (green) with a character height of 7.2 mm for 1 digit.			
	Comparative output	LED indicator (orange) that is lit when the output transistor is turned ON			
	Others	LED indicator (green) for connecting channel and unit display (green)			
Response speed		5 ms max.			
Set resolution		\pm 0.1% FS max.			
Display precision		\pm 1% FS max.			
Protection circuit		Reverse polarity connection, load short-circuiting			
Ambient temperature	Operating	0° to 50°C (32°F to 122°F)			
	Storage	-10° to 60°C with no icing (14°F to 140°F)			
Ambient humidity		35 to 85% RH with no icing			
Supply voltage influence		\pm 1% FS max.			
Temperature influence		\pm 1% FS max.			
Insulation resistance		100 M Ω min. (500 VDC) between current-carry parts and case			
Dielectric strength		1,000 VAC 1 min			
Vibration resistance		10 to 150 Hz, 0.75-mm single amplitude or 100 m/s ² (approx. 10G) for 8 min for 4 times each in X, Y, and Z directions			
Shock resistance		300 m/s ² (approx. 30G) for 3 times each in X, Y, and Z directions.			
Enclosure rating		IEC60529 IP40			
Connecting method		Panel mounting Power supply and output: 7-pin terminal Sensor I/O: 4-pin connector			
Weight (packaged weight)		Approx. 90 g (3.17 oz.)			
Accessories		Instruction manual, Adapter			

Engineering Data (Typical)

LINEAR OUTPUT VOLTAGE VS. PRESSURE

E8MS-01

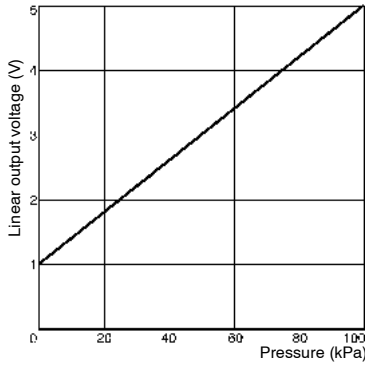

E8MS-10/E8M-10

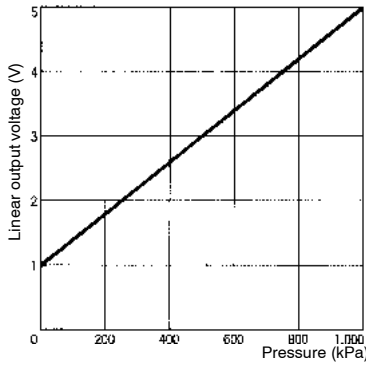

E8MS-N0/E8M-N0

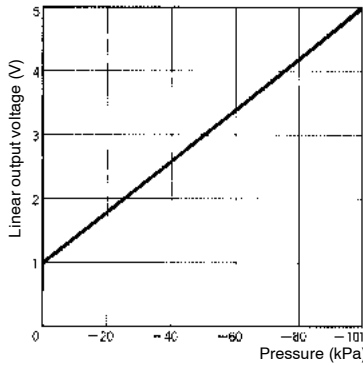

E8M-A1

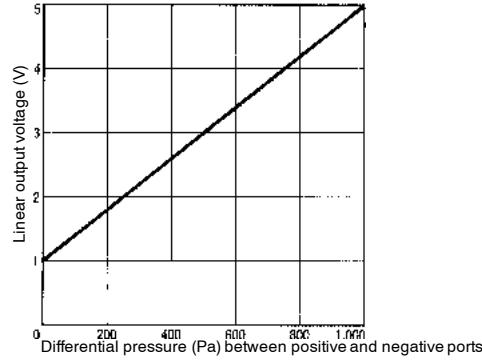

OUTPUT LINEARITY

E8MS-01

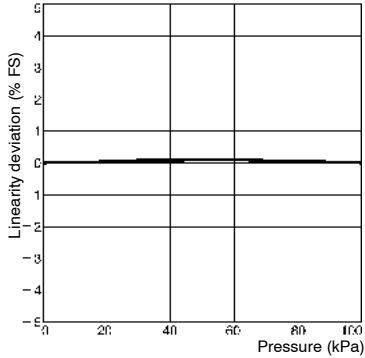

E8MS-10/E8M-10

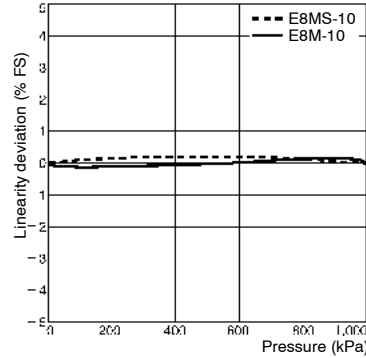

E8MS-N0/E8M-N0

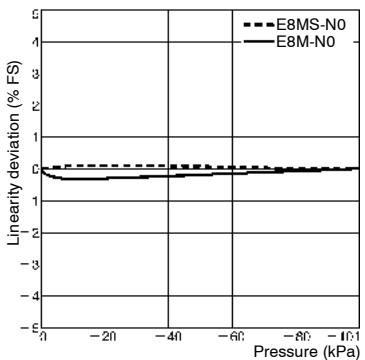

E8M-A1

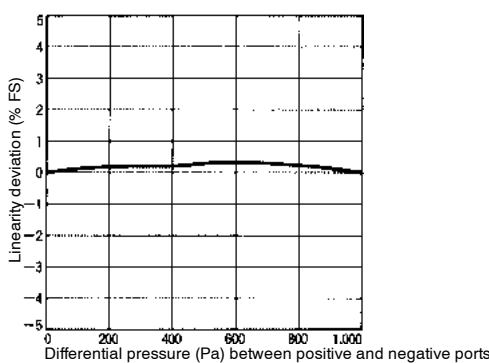

■ LINEAR OUTPUT FLUCTUATION VS. POWER

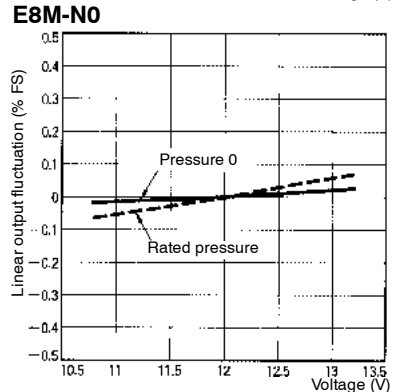
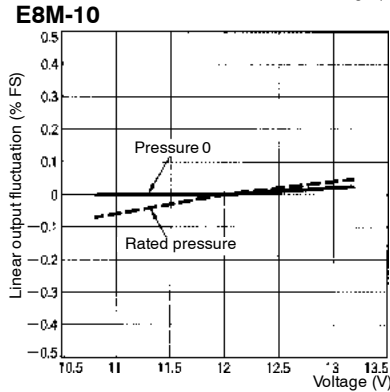
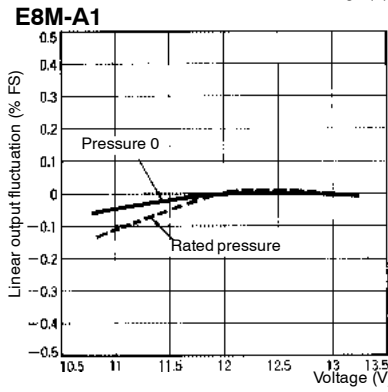
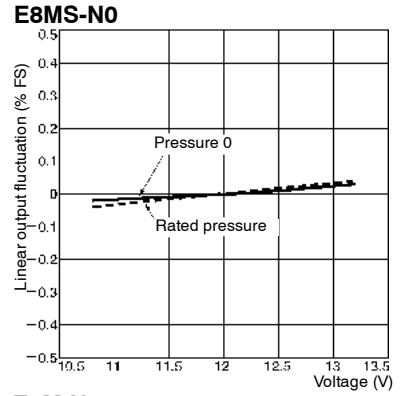
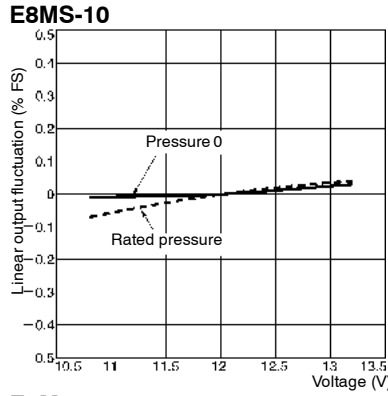
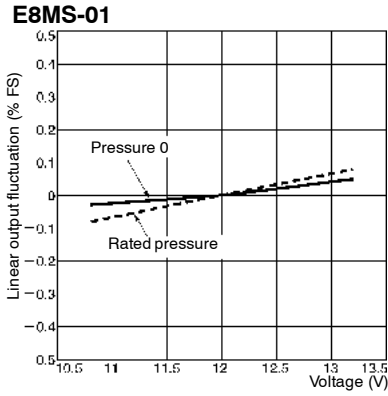

■ LINEAR OUTPUT FLUCTUATION VS. TEMPERATURE

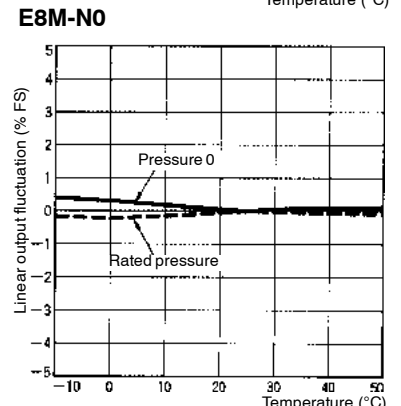
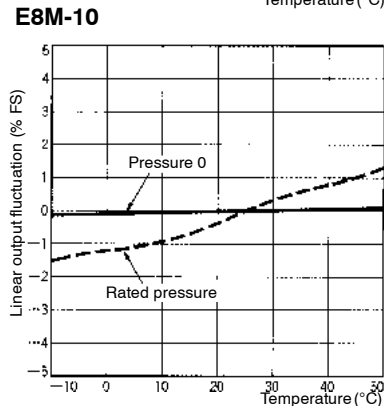
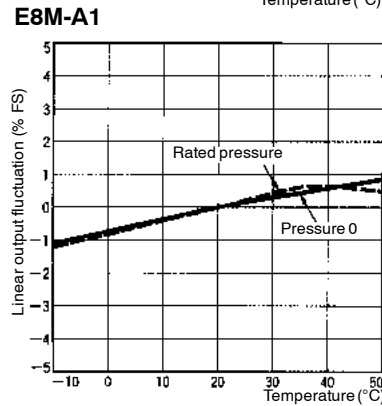
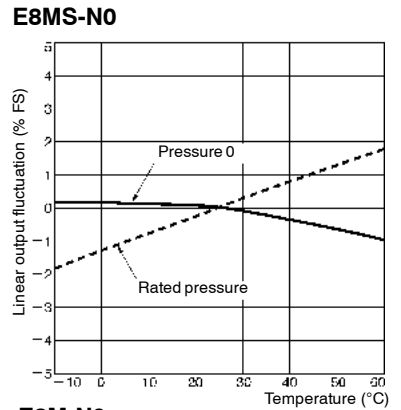
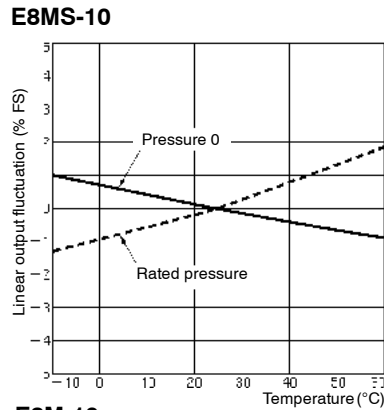
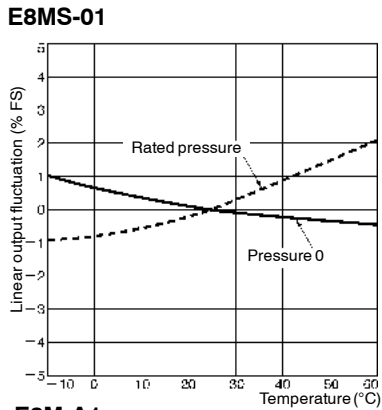

Nomenclature

■ PRESSURE SENSOR CONTROLLER

K3C Controller

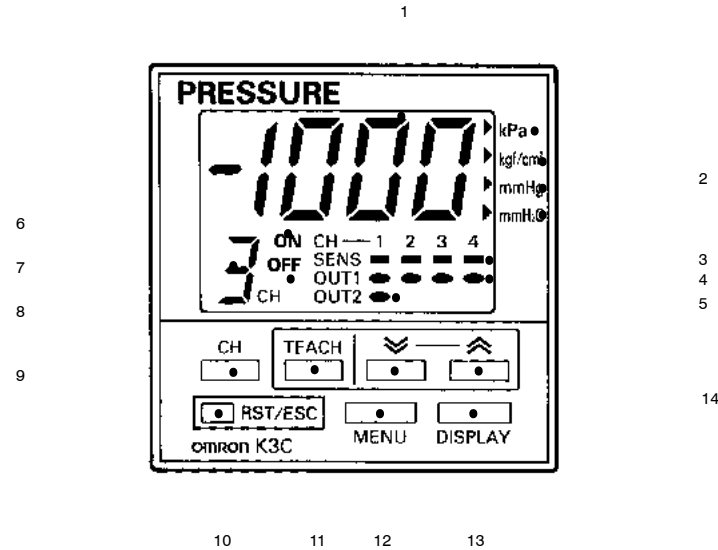

Display Panel

1. **Numeric and Menu Display (Main Display)**
Indicates measurement values and setting menu items. (Red)
2. **Unit Indicator**
Indicates the unit used for sensing. The unit indicated on the indicator is the one currently set. (Green)
3. **Sensor Indicator**
Indicates the operating conditions of Sensors connected to the K3C. When the Sensors are in operation, corresponding indicators are lit. (Green)
Sensors can be connected to channels 1 to 4. Channel 1 has two outputs.
4. **OUT1 Indicator**
Lit when OUT1 is turned ON. (Orange)
5. **OUT2 Indicator**
Lit when OUT2 is turned ON. (Orange)
6. **ON-point Indicator (See Output Control in the *Operation* Section.)**
The ON-point value presently set is displayed in the main display when the ON-point indicator is lit.
7. **Channel Display**
Displays the channel of a Sensor to be in operation or where data is being set. Channels 1 through 4 are available. (Green)
8. **OFF-point Indicator**
The OFF-point value presently set is displayed in the main display when the OFF-point indicator is lit. (Orange)

Operation Keys

9. **CH**
Used to select the channel of a Sensor to be in operation or where menu items are set. A channel is selected in sequence 1 to 4 by repeatedly pressing the CH Key.
10. **RST/ESC**
Used to return to the previous menu. If the RST/ESC Key is pressed right after a set value change, the new set value will be canceled and the display will return to the previous menu. The Controller will be zero-reset if the RST/ESC Key is pressed for 1 s minimum.
11. **TEACH**
Used for teaching settings.
12. **MENU**
Used to select the measurement mode or set mode, to change menu items in set mode, and to enter set values.
13. **DISPLAY**
Used to select the measurement value, ON-point, or OFF-point display in measurement mode.
Set menu or set value display is selected in set mode.
14. **UP/Down**
Used to change the set values in set mode.
The values increase by pressing the Up (▲) Key and decrease by pressing the Down (▼) Key.

Operation

OUTPUT CIRCUITS

Sensor

Output Configuration: 1 to 5 V Linear Output

E8MS-01, E8MS-10, E8MS-N0

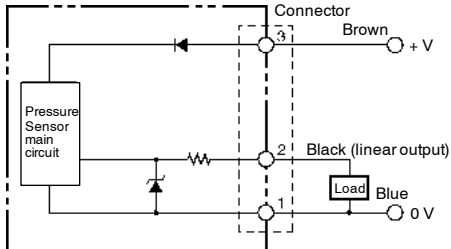

E8M-A1

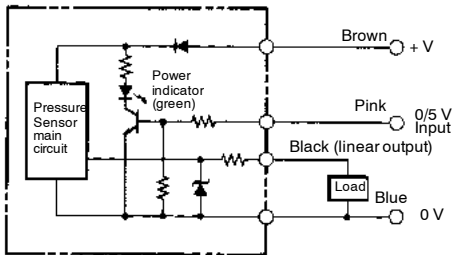

E8M-10, E8M-N0

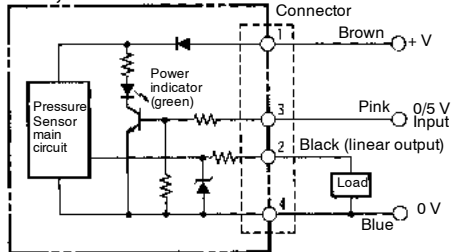

Controller

Output Configuration: NPN Output

K3C-MP8-T1Z

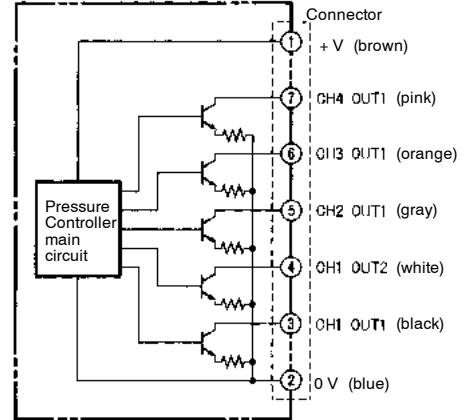

Note: The above colors indicate the conductor colors of the K32-MP2W (Power and output connector for K3C Controller).

■ DISPLAYS OF SETTINGS AND MEASUREMENTS

Digital Display

The E8M displays alphanumeric characters, such as measurement values and menu items, with 7-segment LEDs as shown below for example.

Display	Meaning
SEt	ON and OFF-point <u>Settings</u>
MPa	Unit (<u>kPa</u>)
WID	<u>Width</u>
AVE	<u>Average</u>

The following abbreviations are used for the digital display of the Controller.

Abbreviation	Meaning
SET	Setting
UNT	Unit
OPE	Operation
SEN	Sensor
PRT	Protect
COP	Copy
HYS	Hysteresis
WID	Width
AUT	Auto
DSP	Display
AVE	Average

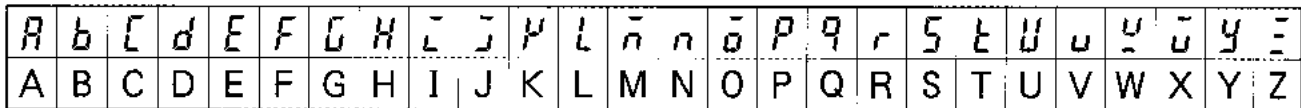

■ MODES

In addition to a measurement value display function, the K3C has a variety of functions including an external device control function. These functions are available in four main modes as described below, where characters in parentheses indicate the digital display conditions. For the relationship among each mode and for switching methods, refer to the following figure.

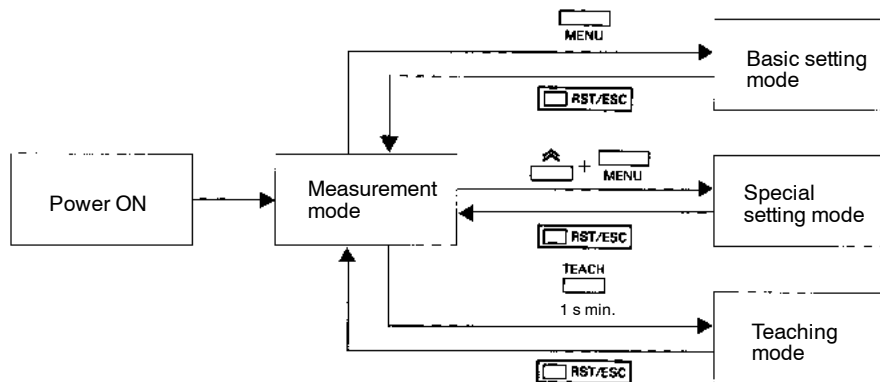

Measurement Mode

The K3C is in this mode when power is turned ON. Normally use the Controller in this mode.

Basic Setting Mode

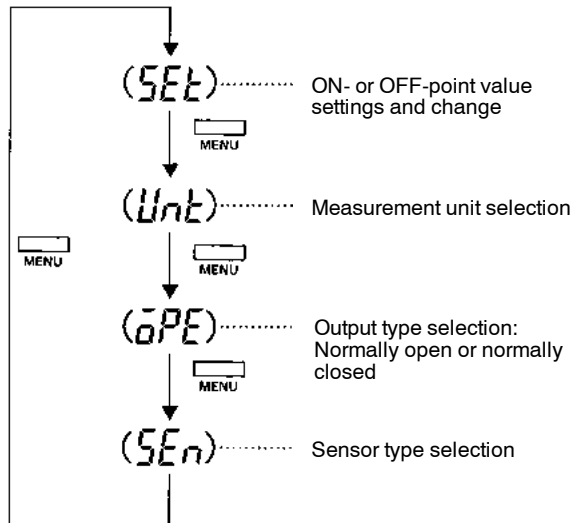

Teaching Mode

Values can be set automatically using measurement values instead of key input.

Special Setting Mode

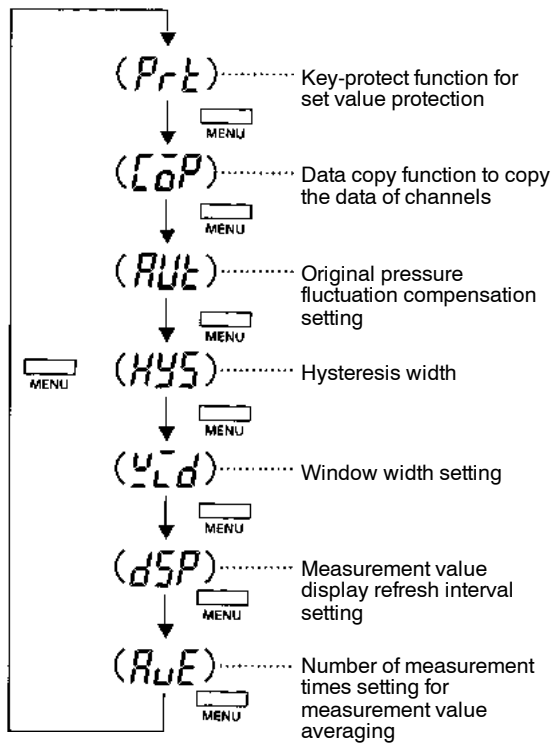

■ SETTINGS

The Controller in pressure sensing operation requires basic settings, such as Pressure Sensor type and measurement unit settings as described in the procedure below.

1. Turning ON the Power

Turn ON the K3C after making sure that the Sensors and power supply to be used are properly connected to the Controller.

Four Pressure Sensors can be connected to the K3C, one of which can be selected with the K3C for measurement value display.

CH1 to CH4 correspond to the four Pressure Sensors respectively.

The K3C displays the measurement value of channel 1 right after the K3C is turned ON.

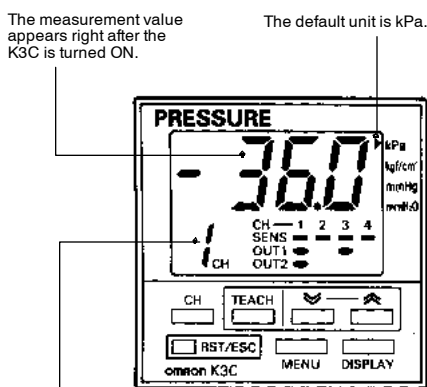

The Sensor on channel 1 is in operation.

2. Channel Selection

Press the CH Key to select the channel to be used. A channel is selected in the sequence 1 → 2 → 3 → 4 by repeatedly pressing the CH Key.

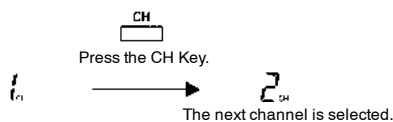

Channel 1 is selected right after the K3C is turned ON. Select the channel where the Sensor to be used is connected. After the channel is selected, set the Sensor type and measurement unit.

3. Sensor Type Selection

Press the MENU Key four times so that "SEN" will appear.

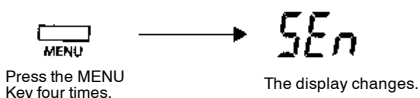

If the display does not change when the MENU Key is pressed, the key-protect function may be enabled. Refer to *Key-protect Settings* (found in the *Advanced Operations Sub-Section*) and disable the key-protect function.

Select the Sensor type according to the target object.

The following Sensor types are available.

Model	Display
E8M-A1	-1
E8MS-N0 E8M-N0	-101
E8MS-10 E8M-10	1000
Not connected	---
E8MS-01	100

Press the DISPLAY Key once.

A Sensor type appears in the main display.

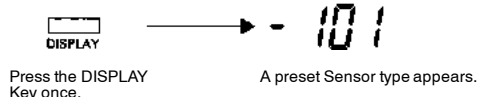

The sensor indicator for the selected Sensor type flashes. Press the Up or Down Key to select the Sensor type according to the Sensor to be used.

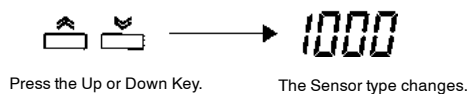

After selecting the Sensor type, press the MENU Key once to enter the Sensor type.

The main display will change to "SET."



4. Measurement Unit Selection

Press the MENU Key once. The main display will change to "UNT" from "SET."

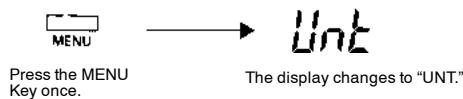

Press the DISPLAY Key once.

A measurement unit will appear in the main display.

The LED display of the selected unit is lit.



Press the Up or Down Key to select the measurement unit to be used.

The LED display of the selected unit is lit.



Note: Selectable measurement units vary with the Sensor type. Any measurement unit that cannot be selected will be skipped.

After the measurement unit is selected, press the MENU Key to enter the measurement unit. The display will change to "OPE."

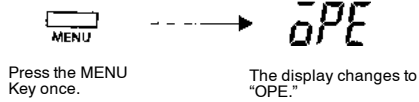

Press the RST/ESC Key. The measurement value will appear in a present setting. This state is called the "measurement mode."

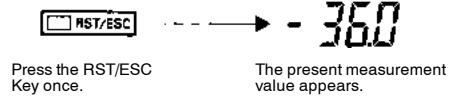

The basic settings are complete.

Reference Table for Sensor Types and Availability of Measurement Units

Sensor type	Pressure range	Display unit				
		MPa (kPa)	kgf/cm ²	mmHg	mmH ₂ O	vol (see note)
E8MS-N0 E8M-N0	0 to - 101 kPa	Yes	Yes	Yes	No	Yes
E8MS-10 E8M-10	0 to 1 MPa	Yes	Yes	No	No	Yes
E8M-A1	0 to - 1,000 Pa	Yes	No	No	Yes	Yes
E8MS-01	0 to 100 kPa	Yes	Yes	No	No	Yes

Note: Select vol for voltage display.

OUTPUT CONTROL

The K3C has output according to the measurement value. The output can be used to control external devices, such as valves and absorption systems.

To control an external device, a reference value must be set so that the output can be turned ON if the measurement value is above the reference value and turned OFF if the measurement value is below the reference value. (The ON/OFF setting can be reversed.)

The value turning the output ON is called the *ON point* and the value turning the output OFF is called the *OFF point*. The following is an example of ON- and OFF-point settings on condition that the Controller has normally open output.

Normally Open Output

Hysteresis Mode

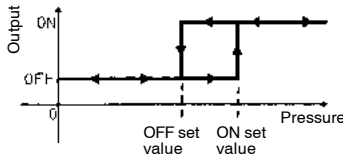

Window Mode

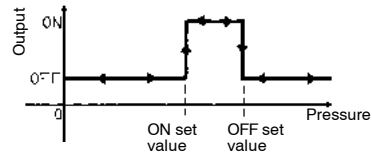

Normally Closed Output

Hysteresis Mode

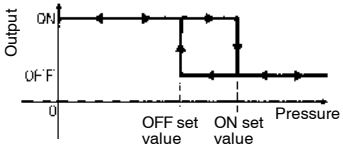

Window Mode

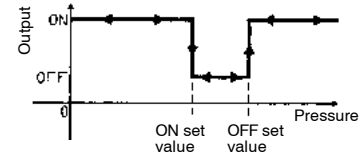

Select the channel where the data is to be set.

- A channel is selected in sequence by repeatedly pressing the CH Key.
- Data can be set on each channel independently.
- Be sure that the channel to be set is correct.

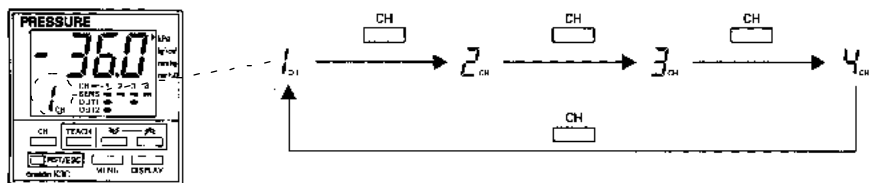

Basic Set Mode

The K3C is in measurement mode right after it is turned ON.

Press the MENU Key once to change the mode to the basic setting mode. "SET" will appear in the main display. If the mode does not change, the key-protect function may be enabled.

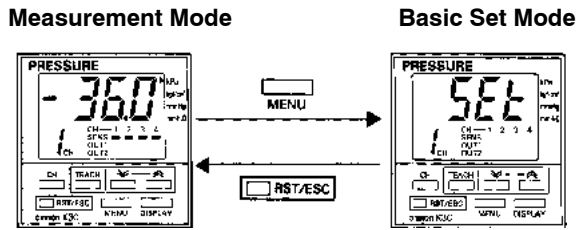

ON- and OFF-point Settings

Set ON- and OFF-points for each channel.

Note: 1. The output method varies with the ON and OFF-point settings.

2. When using the E8M-A1 Minute Differential Pressure Sensor, both the ON point and OFF point must be set to the negative setting. (They cannot be set to the positive setting.)

- The Controller will be in hysteresis mode if the ON-point set value is larger than the OFF-point set value.
 - The Controller will be in window mode if the OFF-point set value is larger than the ON-point set value.
 - The Controller will not be in ON/OFF operation if the ON-point value is the same as the OFF-point set value.
1. Press the DISPLAY Key in basic setting mode with "SET" displayed so that the OUT1 indicator will flash and the ON-point indicator will be lit.
Press the Up or Down Key to change the ON-point set value of OUT1.
 2. Press the DISPLAY Key so that the OUT1 indicator will flash and the OFF-point indicator will be lit.
Press the Up or Down Key to change the OFF-point set value of OUT1.
 3. Press the DISPLAY Key so that the OUT2 indicator will flash and the ON-point indicator will be lit.
Press the UP or Down Key to change the ON-point set value of OUT2.
 4. Press the DISPLAY Key so that the OUT2 indicator will flash and the OFF-point indicator will be lit.
Press the UP or Down Key to change the OFF-point set value of OUT2.
 5. The set values will be entered when the MENU Key is pressed and "UNT" will appear.

Note: If the RST/ESC Key is pressed instead, the set values will not be entered, and "SET" will appear.

When the OUT1 settings are finished and the DISPLAY Key is pressed, OUT2 will be ready for setting only with the channel that has OUT2 output.

Example 1: Channel 1

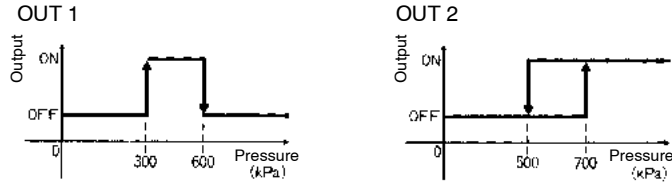

Take the following steps for the above settings with a Sensor with a pressure range of up to 1 MPa.

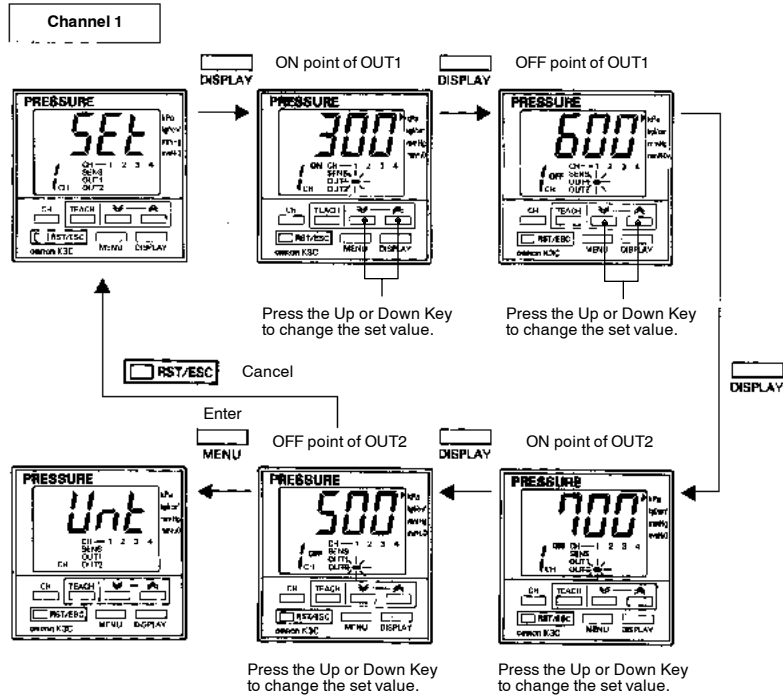

Example 2: Channel 2

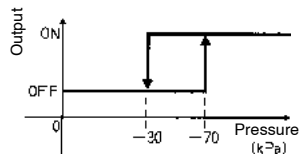

Take the following steps for the above settings with a Sensor with a pressure range of up to -101 kPa.

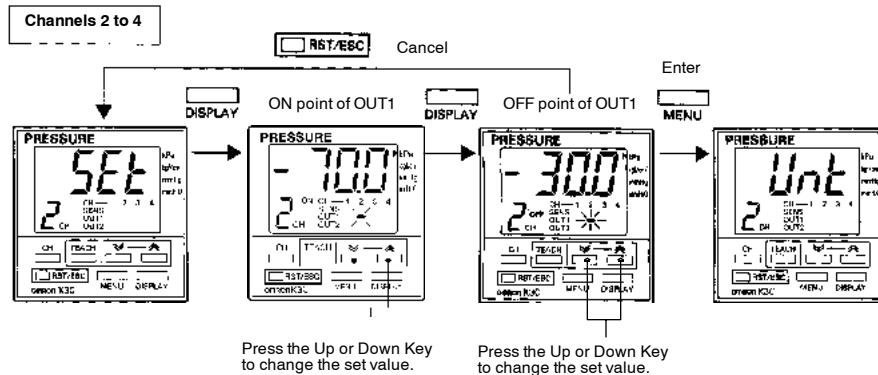

OUTPUT TYPE SELECTION (NORMALLY OPEN OR NORMALLY CLOSED)

Take the following steps to select the output type (normally open or normally closed output) of the K3C.

Hysteresis Mode

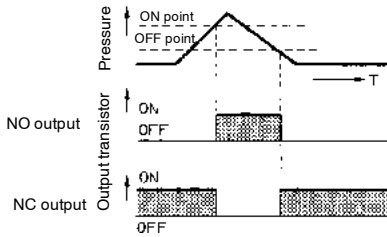

Window Mode

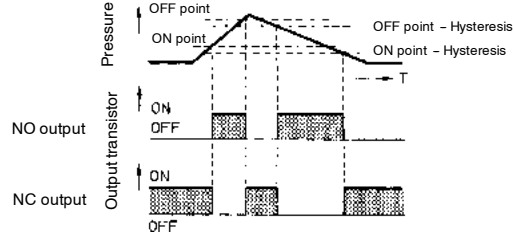

Press the MENU Key three times in measurement mode. "OPE" will appear for output type selection.

The output type presently set will appear by pressing the DISPLAY Key.

NO (normally open) or NC (normally closed) is selected by pressing the Up or Down Key.

By pressing the MENU Key, "SEN" will appear for Sensor type selection after the output type is entered. If the RST/ESC Key is pressed instead, the set values will not be entered and "OPE" will appear again for output type selection.

When the OUT1 settings are finished and the DISPLAY Key is pressed, OUT2 will be ready for setting only with the channel that has OUT2 output.

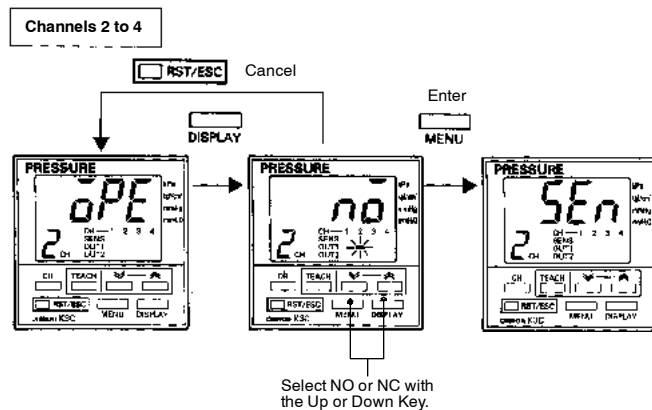
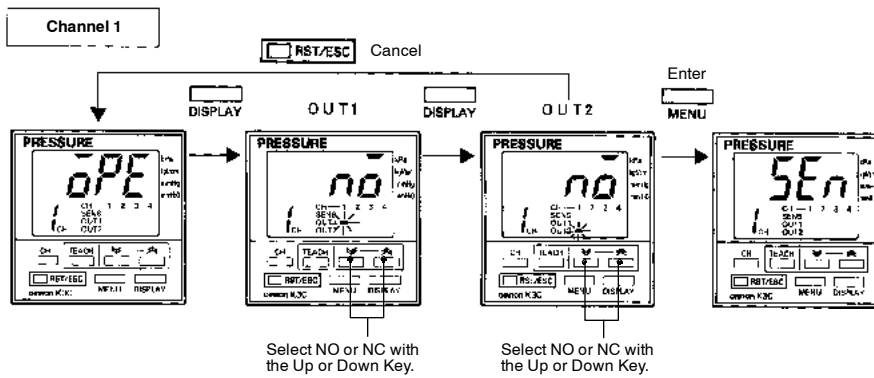

■ SET VALUE CHECK

The ON point and OFF point presently set can be checked with the following steps.

The ON point presently set will appear by pressing the DISPLAY Key. The OFF point presently set will appear by pressing the DISPLAY Key again.

By pressing the DISPLAY Key after OUT1 is displayed, the display will change to OUT2 only with the channel that has OUT2 output.

If there is no key input for 2 s during set value display, the display panel will automatically return to the measurement value display.

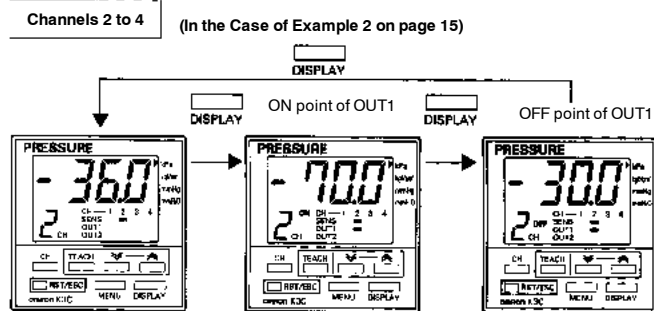
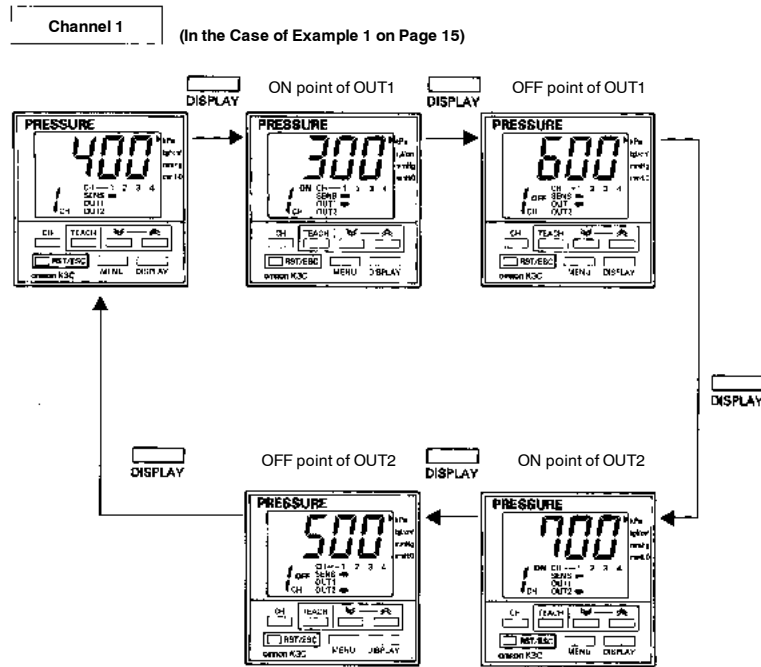

■ ON- AND OFF-POINT SIMPLE SETTING (BY TEACHING)

ON- and OFF-point values can be set by using measurement values instead of key input in the teaching mode.

One-point teaching, which has only one setting point, and two-point teaching, which has two setting points, are both available in the teaching mode.

One-point Teaching

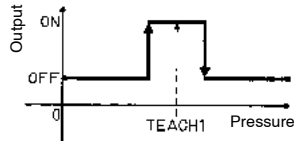

Two-point Teaching

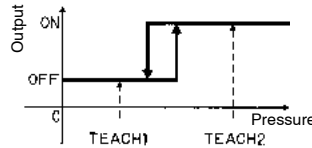

Changing to Teaching Mode

The Controller will go into teaching mode by pressing the TEACH Key for 1 s in measurement mode.

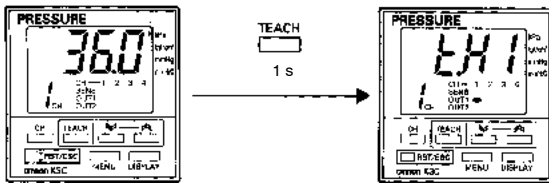

Menu Selection

Two-point teaching (i.e., hysteresis mode teaching) or one-point teaching (i.e., window mode teaching) can be selected by pressing the DISPLAY Key.

By pressing the DISPLAY Key again, OUT2 will be ready for setting for channel 1 only.

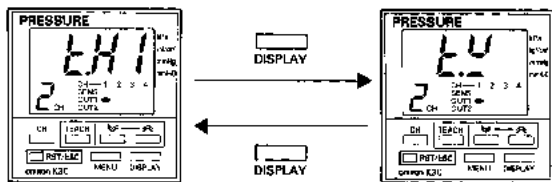

Two-point teaching mode
(hysteresis mode teaching)

One-point teaching mode
(window mode teaching)

Displayed items:

TH1 (teach hysteresis mode, first point)

TW (teach window mode)

Two-point Teaching (Hysteresis Mode Teaching)

1. By pressing the TEACH Key at the point of status 1 as shown below, the present measurement value of the selected channel will appear.
2. Check the measurement value and press the TEACH Key for teaching. Teaching will be completed on the first point.
3. By pressing the TEACH Key at the point of status 2 as shown below, the present measurement value will appear.

Two-point Teaching

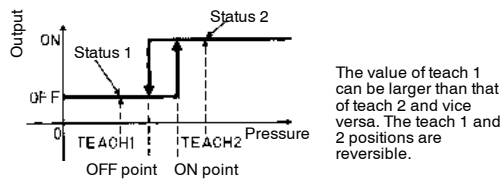

$$\text{ON point} = (\text{Teach 1} + \text{Teach 2}) \div 2$$

$$\text{OFF point} = \text{ON point} - 3\% \text{ FS}$$

Default is 3% FS (can be changed).

4. Check the measurement value and press the TEACH Key for teaching. Teaching will be completed on the second point.
5. Press the RST/ESC Key so that the Controller will be in measurement mode.

Note: The Controller will be in hysteresis mode automatically after two-point teaching.

The above settings are useful for applications that check vacuum absorption.

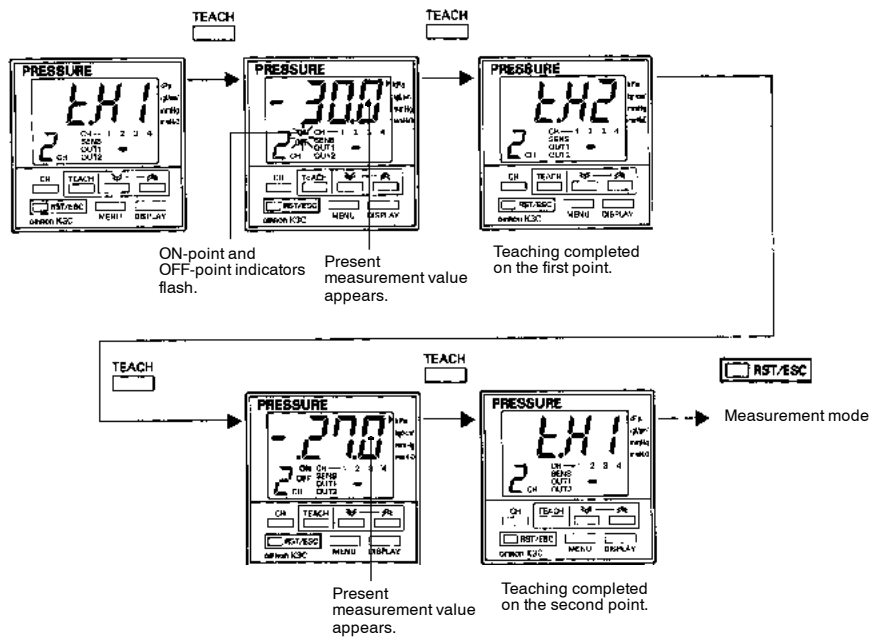

One-point Teaching (Window Mode Teaching)

- By pressing the TEACH Key at the point of status 3 as shown below, the present measurement value will appear and ON- and OFF-point indicators will start flashing.

One-point Teaching

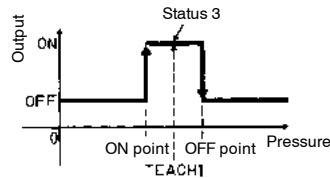

ON point = Teach 1 - 30% FS
 OFF point = Teach 1 + 30% FS
 Default is 10% FS (can be changed).

- Check the measurement value and press the TEACH Key for teaching. Teaching will be completed on the ON and OFF points.
- Press the RST/ESC Key so that the Controller will be in measurement mode.

Note: The Controller will be in window mode automatically after one-point teaching.

The above settings are useful for applications that check original pressures.

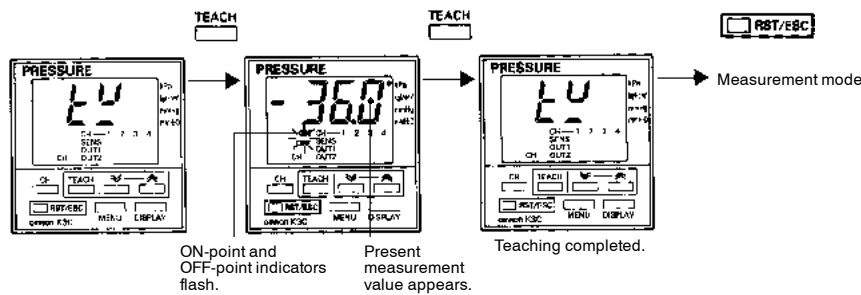

ON- and OFF-point Set Values

Refer to *Set Value Check* on page 17 to check ON- and OFF-point set values.

Teaching Errors

Teaching will not be performed by pressing the TEACH Key if the present value or the result of teaching is not within the proper setting range, in which case, "ER.T" (error teach) will appear for 1 s.

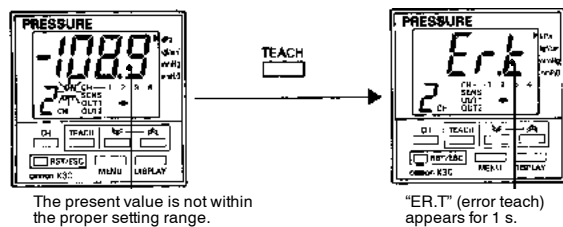

Measurement Value Zero-reset

Note: The Controller can be zero-reset provided that the Sensor is exposed to atmospheric pressure.

The present measurement value will be reset as zero by pressing the RST/ESC Key for 1 s. The possible zero-reset range is within $\pm 5\%$ FS of the rated output. Otherwise, "ER.T" will appear and the present measurement value will not be reset.

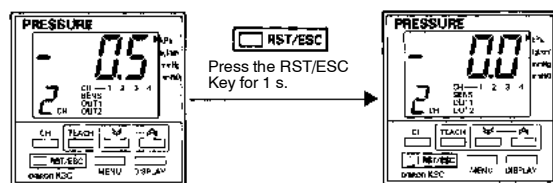

ADVANCED OPERATIONS (SPECIAL SETTING MODE)

The Controller in this mode allows the use of versatile functions for data protection, data copying, and fine setting adjustments.

Changing to Special Setting Mode

The Controller in measurement mode will be in special setting mode if the MENU Key is pressed while the Up Key is pressed.

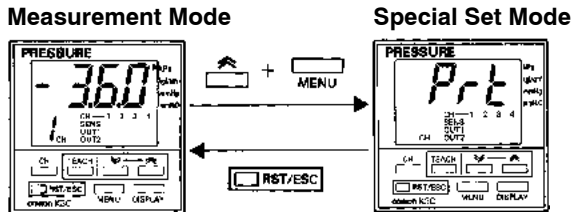

Menu Selection

When PRT is displayed, press the MENU Key. "COP" will appear. Select the menu to be set. The display will change to "PRT," "COP," "AUT," "HYS," "WID," "DSP," and "AVE" in sequence by repeatedly pressing the MENU Key (refer to page 10).

The Controller will be in measurement mode by pressing the RST/ESC Key regardless of the menu selected.

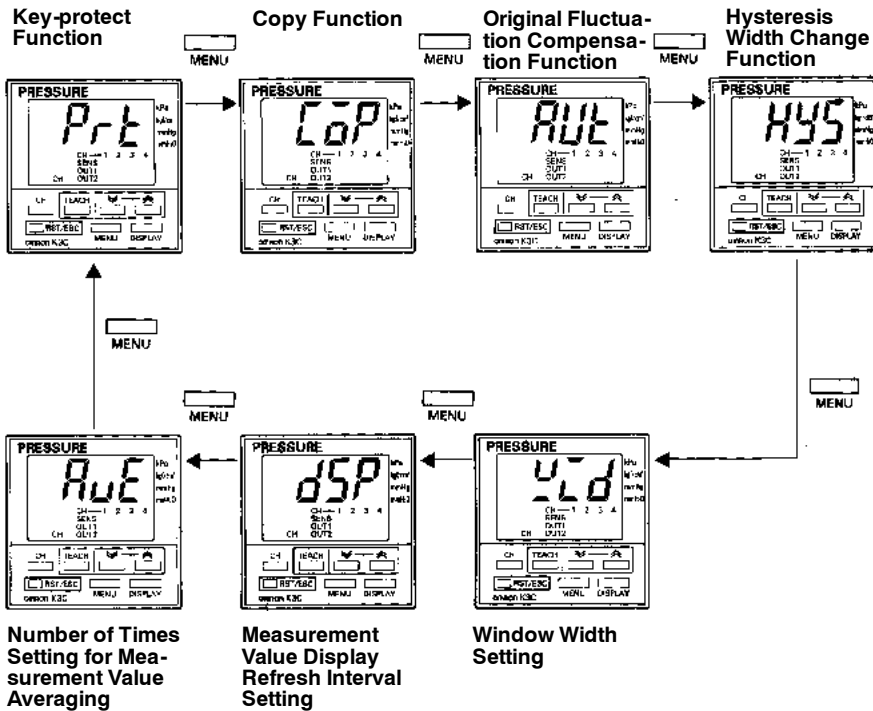

Key-protect Settings

1. The protect set value will appear by pressing the DISPLAY Key.
2. Press the Up or Down Key to change the set value.
3. The set value will be entered and "COP" will appear by pressing the MENU Key.
If the RST/ESC Key is pressed, set value change will not be entered and "PRT" will appear.

Key-protect Status

- 0: No key protect
- 1: No key protect in SET, UNT, zero-reset, or teaching operation, zero-reset, and all set modes.
- 2: Key protect in teaching operation.

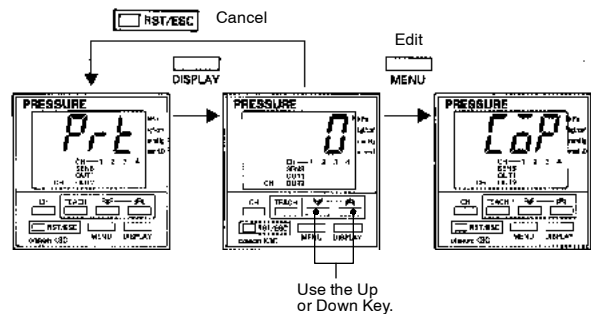

Set Value Channel-to-channel Copy

Data set in a channel can be copied and used for other channels.

1. Press the DISPLAY Key, and the source channel that has data to be copied will appear on the main display with the destination channel.
2. Press the Up or Down Key to select the source channel.
3. Select the destination channel with the CH Key.
4. Press the TEACH Key to copy the data.

Note: When using the K3C-MP8-T1Z 4-channel model, the OUT2 data on channel 1 will be ignored if the contents of channel 1 are copied to channels 2 through 4. If the contents of channels 2, 3, or 4 are copied to channel 1, there will be no difference in data between OUT1 and OUT2 of channel 1.

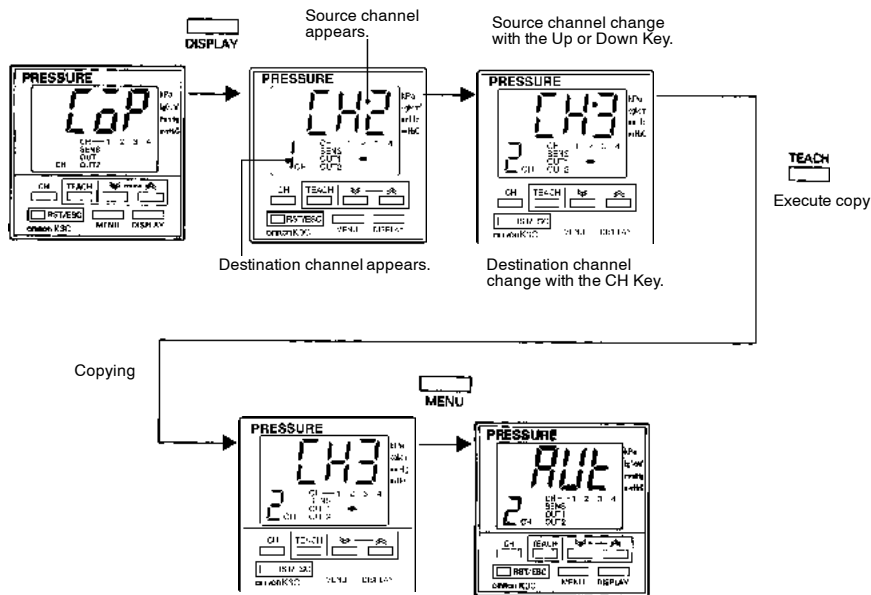

Automatic Compensation of Set Value for Original Pressure Fluctuation

When using the K3C-MP8-T1Z 4-channel model, the set values on channels 2 through 4 can be compensated according to the original pressure fluctuation that is input to channel 1. When using the K3C-DP8-T1Z 2-channel model, the CH2 setting can be compensated.

Compensation value = Original pressure fluctuation (%) x compensation coefficient

Compensation is performed every minute by comparing the one-minute mean value and reference value of the original pressure. The reference value is the mid-value between the ON- and OFF-points of OUT 1 on channel 1.

1. The compensation coefficient will appear by pressing the DISPLAY Key.
2. Select the channel for value compensation.
3. On the basis of no compensation as 0 times, change the compensation coefficient with the Up or Down Key within a range between 0 to 10 times.
4. The compensation coefficient is entered and "HYS" will appear by pressing the MENU Key.
If the RST/ESC Key is pressed after a compensation coefficient change, the new compensation coefficient will be canceled and "AUT" will appear.

Note: 1. Channel 1 will be skipped in the original pressure compensation menu.

2. When using the K3C-DP8-T1Z 2-channel model, the compensation coefficient setting is common to OUT1 and OUT2.

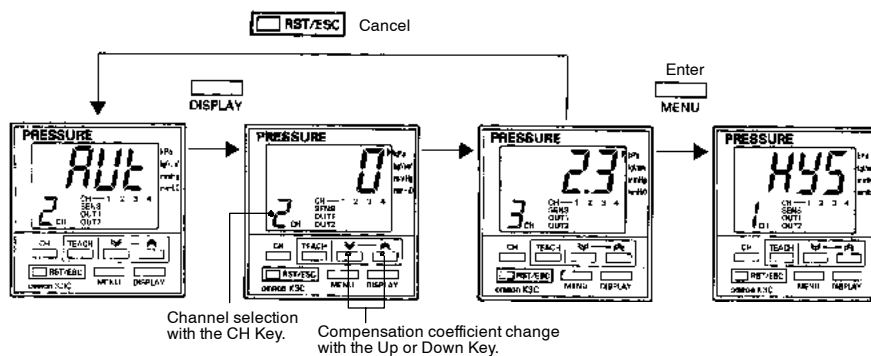

Hysteresis Width Change

Hysteresis width change is possible as shown below.

Hysteresis Mode

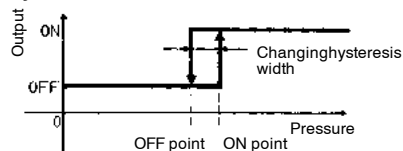

Window Mode

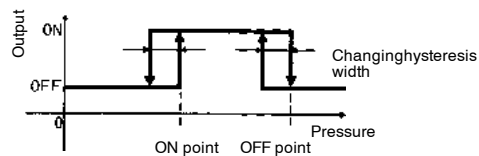

1. The hysteresis width set value will appear by pressing the DISPLAY Key.
2. Select the channel where hysteresis width change is required with the CH Key.
3. Press the Up or Down Key to change the set value within a range between 0.1% and 10.0% FS.
4. The set value will be entered and "WID" will appear by pressing the MENU Key.
If the RST/ESC Key is pressed, set value change will be canceled and "HYS" will appear.

Note: 1. The above settings in hysteresis mode will be invalid if data is set in the menu while "SET" is displayed. The above settings in hysteresis mode will be valid only if data is set by teaching. The above settings in window mode are valid in measurement mode.

2. The width between the ON and OFF points are used as the hysteresis width in hysteresis mode. Therefore, the settings cannot be changed in the above steps.
3. By pressing the DISPLAY Key after OUT1 is displayed, the display will change to OUT2 only with the channel that has OUT2 output.

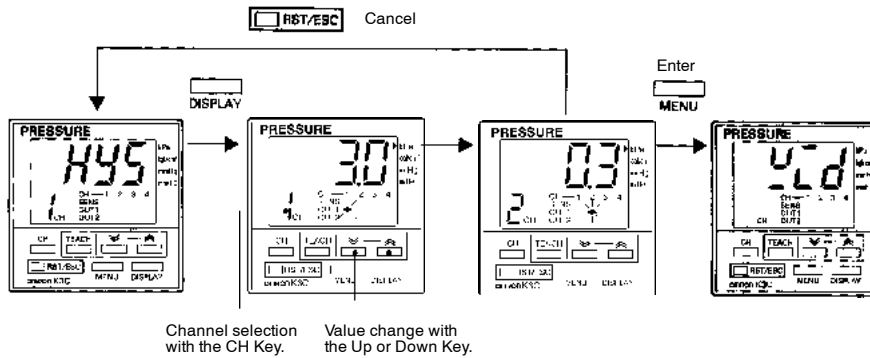

Window Width Change (Valid Only with One-point Teaching in Window Mode)

1. The window width set value will appear by pressing the DISPLAY Key.
2. Select the channel where hysteresis width change is required with the CH Key.
3. Press the Up or Down Key to change the set value within a range between 0% and 30% FS of the reference value as shown in the following graph.

Note: Setting to 0% FS will disable ON/OFF operation.

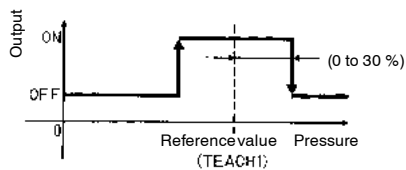

4. The set value is entered and "DSP" will appear by pressing the MENU Key.
If the RST/ESC Key is pressed, set value change will be canceled and "WID" will appear.

Note: 1. The above settings will be invalid if the Controller is used in hysteresis mode.

2. By pressing the DISPLAY Key after OUT1 is displayed, the display will change to OUT2 only with the channel that has OUT2 output.

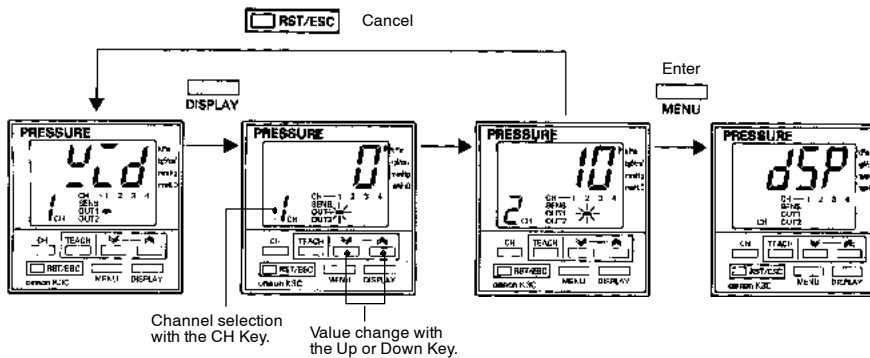

Measurement Value Display Refresh Interval Change

One of the following refresh intervals can be selected.

- 0.1: Measurement values are averaged and refreshed every 0.1 s.
- 0.5: Measurement values are averaged and refreshed every 0.5 s.
- 1.0: Measurement values are averaged and refreshed every 1 s.

1. The display refresh interval set value will appear by pressing the DISPLAY Key.
2. Press the Up or Down Key to change the set value.
3. The set value will be entered and "AVE" will appear by pressing the MENU Key.
If the RST/ESC Key is pressed, set value change will be canceled and "DSP" will appear.

Note: The number of measurement times for measurement value averaging is set in the menu while "AVE" is displayed.

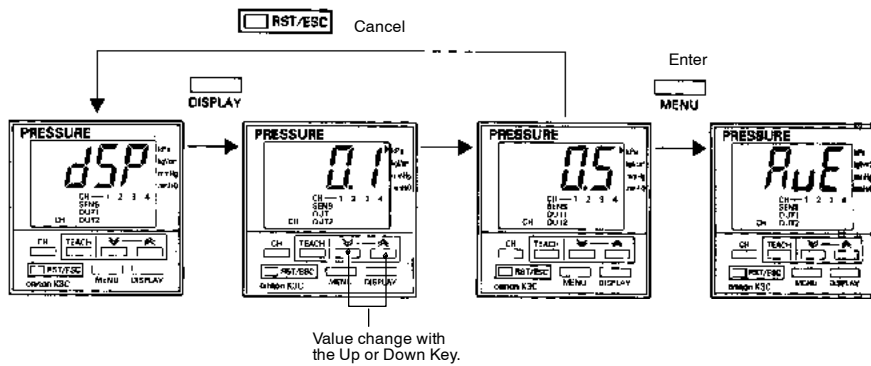

Number of Measurement Times Setting Change for Measurement Value Averaging

One of the following number of times can be selected: 1, 8, 32, and 256

1. The number of measurement times set value will appear by pressing the DISPLAY Key.
 2. Press the Up or Down Key to change the set value.
 3. The set value will be entered and "PRT" will appear by pressing the MENU Key.
- If the RST/ESC Key is pressed, set value change will be canceled and "AVE" will appear.

Note: If 0.5 is set while "DSP" is displayed and 32 is set while "AVE" is displayed, pressure will be measured 32 times and averaged as a block. The averaged blocks as a mean value will be displayed and refreshed every 0.5 s.

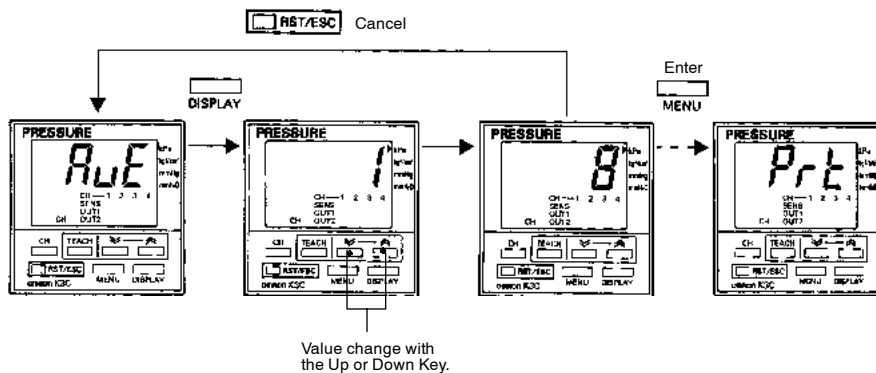

■ ERROR DISPLAY

Contents	Display	Error code	Reset method	Output (OUT1, OUT2)
Sensor error	Error code flashes.	<i>Err</i>	Reset the power supply.	All OFF
Input lower limit error	Flashes at the lower limit. (Corresponding sensor indicator flashes.)	None	Automatically reset when the input returns to the specified range.	Normal operation
Input upper limit error	Flashes at the upper limit. (Corresponding sensor indicator flashes.)	None	Automatically reset when the input returns to the specified range.	Normal operation
Output load short-circuiting	Output indicator flashes.	None	Automatically reset when the short-circuit is removed.	Only the corresponding channel flashes.
Teaching input range error	Error code flashes.	<i>Err</i>	Not registered. (Error is displayed for one second.)	All OFF during teaching.
Zero reset range error	Error code flashes.	<i>Err</i>	Not registered. (Error is displayed for one second.)	Normal operation

Dimensions

Unit: mm (inch)

■ SENSORS

**E8MS-01
E8MS-10
E8MS-N0**

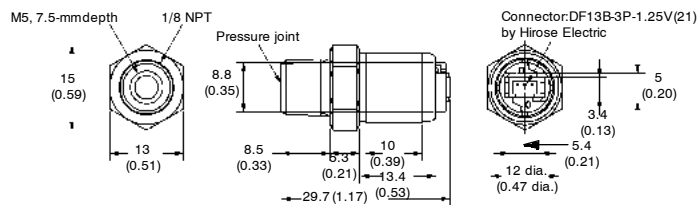
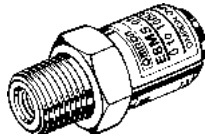

**Connection with E89-M4
Sensor I/O Connector**

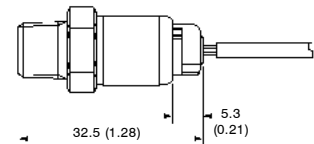

E8M-A1

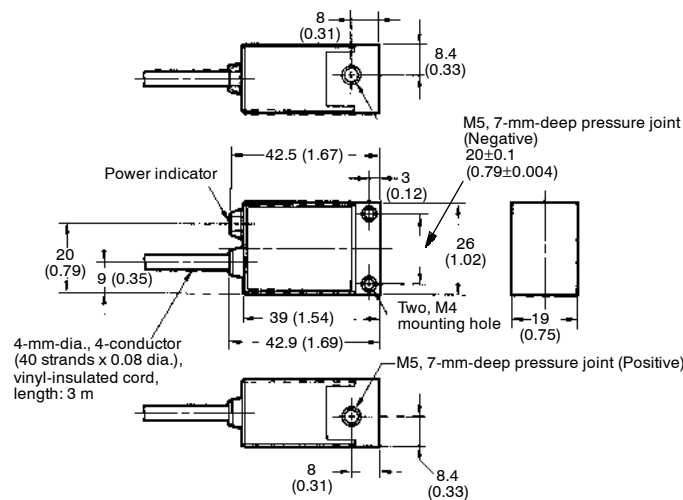
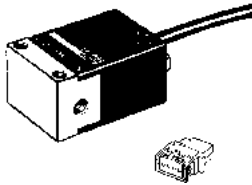

E8M-10

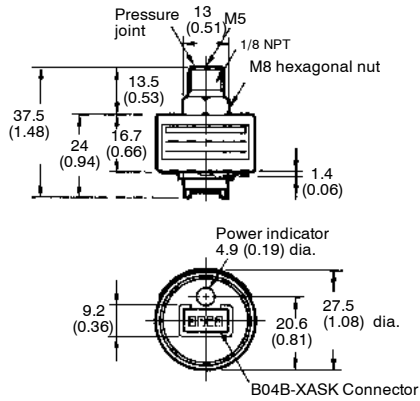
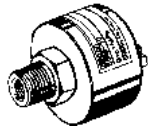

Connection with E89-M3 Sensor I/O Connector

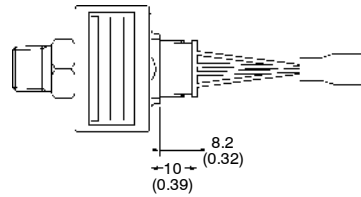

E8M-N0

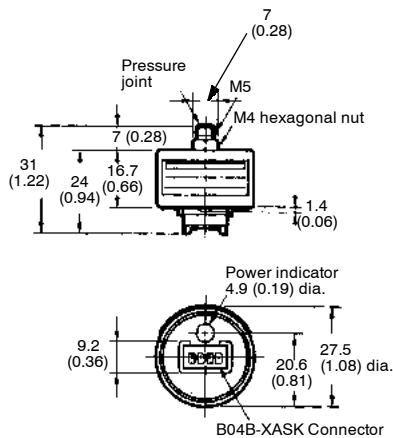
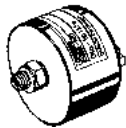

Connection with E89-M3 Sensor I/O Connector

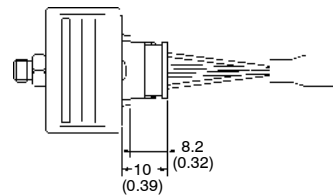

E89-M3 Sensor I/O Connector Cable for E8M

(Sold separately) Includes one XS8A-0442 cable Connector.

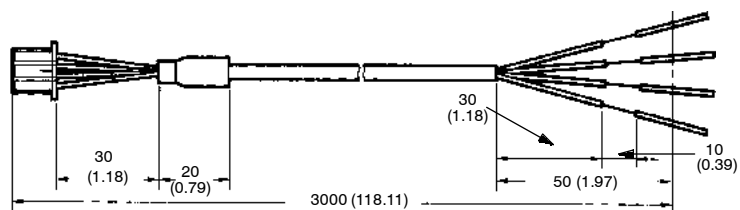
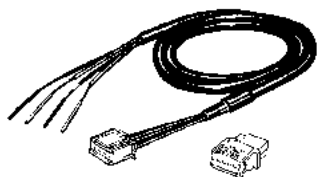

E89-M4 Sensor I/O Connector Cable for E8MS

(Sold separately) Includes one XS8A-0442 cable Connector.

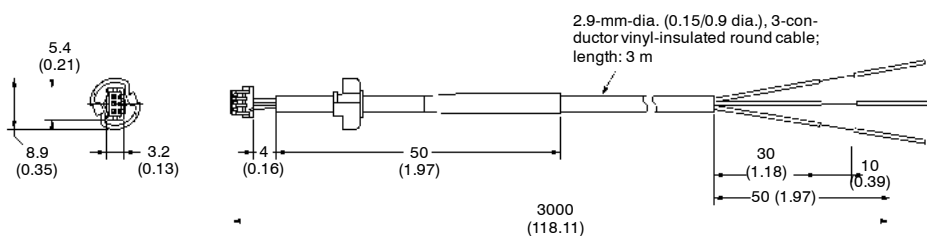
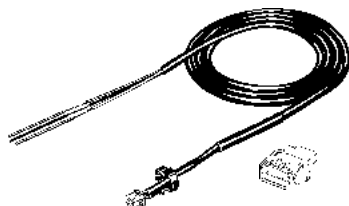

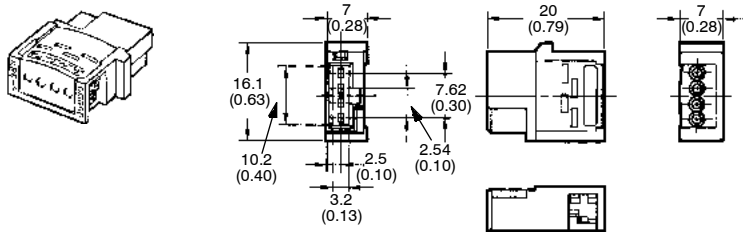
XS8A-0442 Cable Connector (One Connector is Supplied with the E8M-A1)

One XS8A-0442 Cable Connector is provided with the E89-M3 and E89-M4 Sensor Connector Cable. Refer to the *Ordering Information* section for replacement orders.

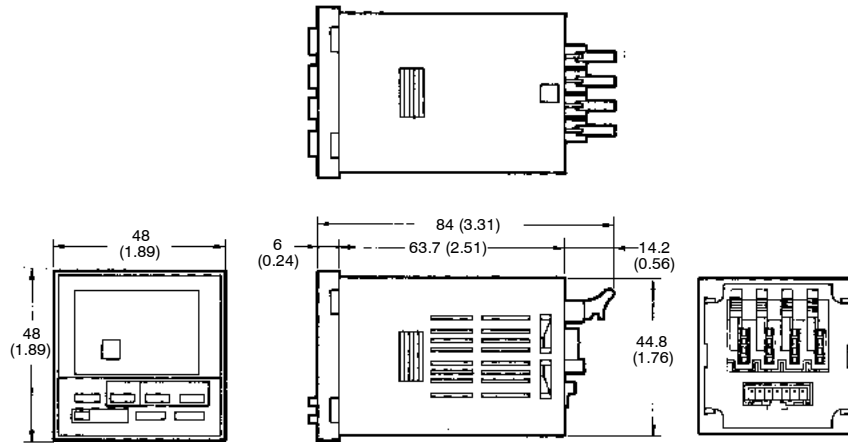
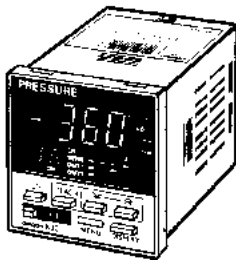
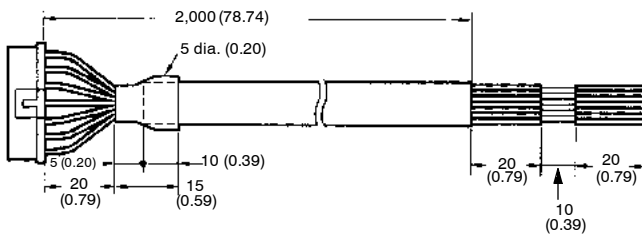
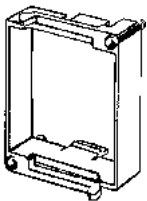
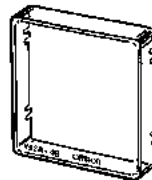
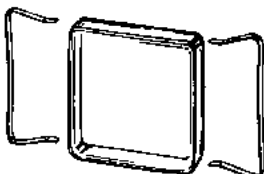
CONTROLLER**K3C-MP8T1Z****K32-MP2W (Power and Output Connector for K3C Controller)
(Sold Separately)****Adapter (Provided with Controller)****Y92A-48 Hard Cover (Sold Separately)****Y92A-48F1 Soft Cover (Sold Separately)****Note: Protection from Water and Oil**

The Controller is of a water-resistant construction which protects the internal circuitry from water that may enter through the space between the front panel and any key. Use the Soft Cover, however, if the Controller is to be operated with wet or oily hands. Although the Soft Cover conforms to IEC IP54F, do not install the Controller with the Soft Cover in places where oil may be directly sprayed onto the Controller.

Installation

ASSEMBLY PROCEDURE

For the E89-M3/M4 Sensor I/O Connector Cable (Sold Separately) and XS8A-0442 Cable Connector (Provided with Sensor)

1. Processing the Sensor I/O Connector Cable End

The cable end is semi-stripped.

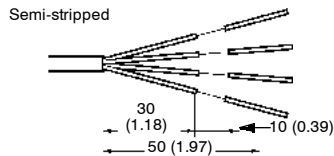

Cut the ends as shown in the following illustration, and do not peel the shield.

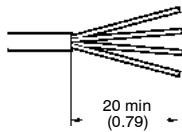

2. Fitting Controller Conductors to Cable Connector Cover

Terminal numbers are engraved on the cover. Refer to the following and be sure that these terminal numbers correspond to the wire colors correctly.

Terminal No.	E89-M4	E89-M3
	I/O code	
1	Black (Output)	
2	---	Pink (LED lighting input)
3	Brown (Vcc)	
4	Blue (GND)	

Note: Pin 2 will be empty when the E89-M4 is mounted.

Check again that the terminal numbers correspond to the wire colors correctly. Then, insert the cover into the plug connector.

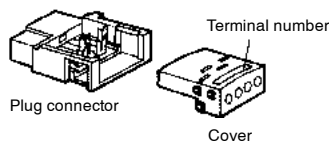

Be sure that the cover is fully inserted into the plug connector.

3. Connecting Wires to Plug Connector

Tentatively place the wired cover on the plug connector.

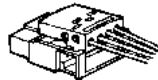

Press the cover and fit the wires. Pliers can be used, in which case, apply the pliers to the middle part of the cover and press the cover as straight as possible against the plug connector.

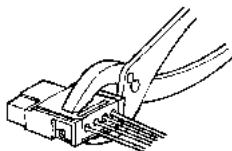

Be sure that there is no space between the cover and plug connector.

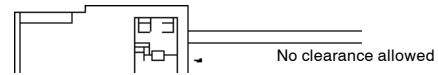

Check through the window of the cover that the wires are fitted to the plug connector properly.

Once attached to the plug connector, the cover and plug connector cannot be reused. Before using the pliers to attach the cover, be sure that the terminal numbers correspond to the wire colors correctly. If the wires are connected to the plug connector incorrectly, use a new cable connector.

4. Connecting/Disconnecting Controller Connector to/from the K3C-MP8-T1Z Four-channel Pressure Controller

Be sure that terminal number 1 engraved on the cable connector is facing upwards (i.e., on the lock-lever side) and press the cable connector against the socket connector until the cable connector snaps in place.

Lift up the lock lever before disconnecting the plug connector.

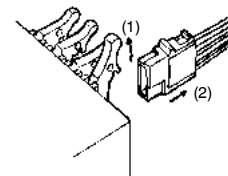

Sensor and Controller Combinations

Use the Pressure Controllers in the following combinations. The E89-M3/M4 is required when using the Sensor as a single unit.

Model	E89-M3	E89-M4	K3C-MP8-T1Z K3C-DP8-T1Z	K32-MP2W
E8MS-01	×	○	○	○
E8MS-10	×	○	○	○
E8MS-N0	×	○	○	○
E8M-A1	×	×	○	○
E8M-10	○	×	○	○
E8M-N0	○	×	○	○

Note: ○: Required; ×: Not required.

Sensor and Controller Connection

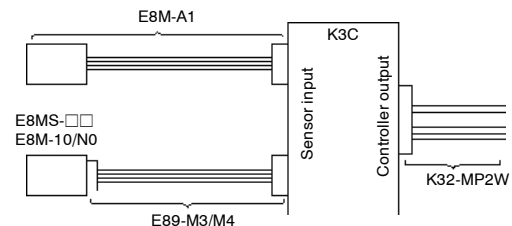

Precautions

■ APPLICATIONS

You must allow sufficient leeway in ratings and performance and provide proper fail-safe and other safety measures when using the Link the E8M in any of the following applications. Be sure also to consult with your OMRON representative before actually attempting any of these applications.

1. Applications under conditions or environments not specified in the instructions sheets.
2. Applications for nuclear reactor control, train facilities, aviation facilities, motorized vehicles, furnaces, medical equipment, amusement equipment, and safety equipment.
3. Applications strongly related to human life or property, particularly those requiring safety.

■ WARNINGS

Environment

Do not use the Sensor in locations subject to explosive or flammable gases.

Power Supply Voltage

Do not apply voltages in excess of the specified power supply voltage range. Applying voltages beyond the specified range may result in burning.

Short-circuit in Load

Do not short-circuit the load. Short-circuit the load may result in breaking or burning.

Incorrect Wiring

Be sure to connect to the polarities of the power supply correctly and avoid incorrect wiring. Incorrect connection or wiring may result in breaking or burning.

■ CORRECT USE

Connecting and Locking the E8MS Sensor I/O Connector (E89-M4)

1. Hold both ends of the female connector connected to the Sensor I/O Connector so that the protrusion on the female connector faces upward, orientate the hole in the male connector on the Sensor upwards, and insert the female connector into the hole until the protrusion clicks in.

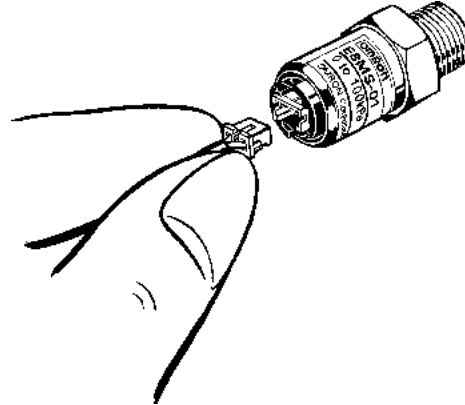

2. A lock cover is slid through the Sensor I/O Connector to prevent it from coming free due to vibration or shock. Insert the lock cover facing in the correct direction (a) as shown in the following figure, and rotate it clockwise (b) until it clicks in.

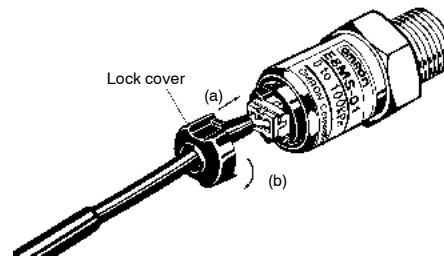

3. To unlock the connector, rotate the lock cover counterclockwise until it clicks, then pull it towards you. To disconnect the connector, hold both ends of the connector, then pull it towards you.

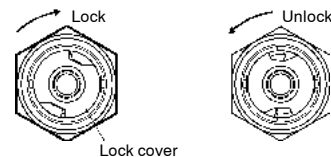

Note: Forcibly pulling the cable to disconnect the connector may damage the pressure-welded portion. Be sure to hold both ends of the connector when disconnecting it.

E8MS-□□/ E8M-10

The pressure-introducing section (aluminum for E8MS, SUS304 for E8M) is fixed with tapered 1/8 NPT male screws and M5 female screws.

When using tapered screws, use tapered 1/8 NPT female screws. Wrap the tapered 1/8 NPT male screws with sealing tape to prevent any leakage. Tighten the male screws to a torque no more than 3.9 N • m (2.88 ft • lbs).

Tighten M5 female screws to a torque no more than 1 to 1.5 N • m (0.74 to 1.11 ft • lbs).

When tightening a screw, hold by its hexagonal head, not by its body.

E8M-NO

The pressure-introducing section (SUS304) is fixed with M5 male screws.

Tighten male screws to a torque no more than 1 to 1.5 N • m (0.74 to 1.11 ft • lbs).

When tightening a male screw, hold by its hexagonal head, not by its body.

E8M-A1

The pressure-introducing section (SUS303) is fixed with M5 female screws (7 mm deep).

Tighten screws for the pressure-introducing section to a torque no more than 1 to 1.5 N • m (0.74 to 1.11 ft • lbs).

M4 female screws are used for the product mounting sections.

When mounting the product, tighten the screws while holding a metal part of the product, not a resin part.

Tighten the product mounting screws to a torque no more than 1.2 N • m (0.89 ft • lbs).

If the positive pressure section is released and positive pressure is applied to the negative pressure section, a positive pressure may be displayed.

All Models

Do not use the Sensor in an environment subject to corrosive or combustible gases.

Be sure to use the Sensor in an environment where air-borne water or oil is removed by air filters.

Do not use the Sensor alongside a high-tension voltage line or power line.

Do not expose the Sensor to water.

Mount the Sensor so that ultrasonic vibrations will not be applied directly to the Sensor.

Be sure to use the Sensor under the rated pressure.

Do not insert any wire into the pressure sections. Doing so may damage the pressure elements and cause a malfunction.

Do not apply any tensile strength in excess of 20N (4.5 lbs) for E8MS, 30N (6.75 lbs) for E8M to the cables or connectors.

Do not pull the cables. When removing the connectors for external connection, be sure to use the lock lever.

K3C

Install the Sensor horizontally.

The recommended panel thickness is 1 to 5 mm (0.04 to 0.20 in).

Do not install the Sensor in an environment subject to strong vibration or shock.

Do not install the Sensor under dusty conditions.

Do not install the Sensor in an environment subject to corrosive gases, particularly sulfide and ammonia gases.

Do not install the Sensor near equipment that generates strong high-frequency noise such as high-frequency welders or sewing machines.

NOTE: DIMENSIONS SHOWN ARE IN MILLIMETERS. To convert millimeters to inches divide by 25.4.

OMRON[®]**OMRON ELECTRONICS LLC**One East Commerce Drive
Schaumburg, IL 60173**1-800-55-OMRON****OMRON ON-LINE**Global - <http://www.omron.com>USA - <http://www.omron.com/oei>Canada - <http://www.omron.com/oci>**OMRON CANADA, INC.**885 Milner Avenue
Scarborough, Ontario M1B 5V8**416-286-6465**