

# Photomicrosensor (Transmissive) EE-SX1235A-P2

Be sure to read *Precautions* on page 25.

## ■ Dimensions

**Note:** All units are in millimeters unless otherwise indicated.

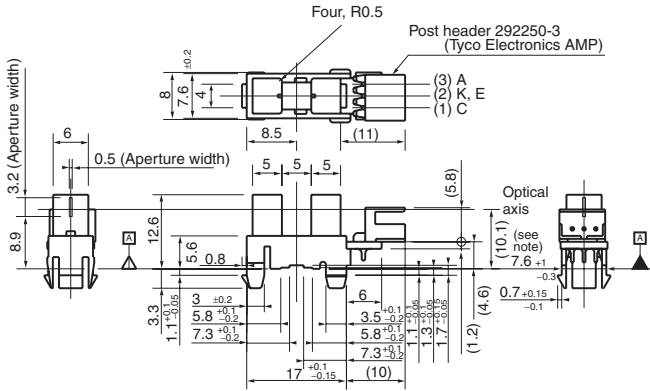

### Internal Circuit

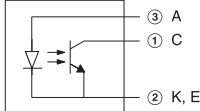

**Note:** The asterisked dimension is specified by datum A only.

Unless otherwise specified, the tolerances are as shown below.

| Dimensions   | Tolerance |
|--------------|-----------|
| 3 mm max.    | ±0.3      |
| 3 < mm ≤ 6   | ±0.375    |
| 6 < mm ≤ 10  | ±0.45     |
| 10 < mm ≤ 18 | ±0.55     |
| 18 < mm ≤ 30 | ±0.65     |

| Terminal No. | Name             |
|--------------|------------------|
| A            | Anode            |
| C            | Collector        |
| K, E         | Cathode, Emitter |

Recommended Mating Connectors:  
 Tyco Electronics AMP 173977-3 (press-fit connector)  
 175778-3 (crimp connector)  
 179228-3 (crimp connector)

## ■ Features

- Snap-in mounting model.
- Mounts to 1.0-, 1.2- and 1.6-mm-thick PCBs.
- High resolution with a 0.5-mm-wide aperture.
- 5-mm-wide slot.
- Connects to Tyco Electronics AMP's CT-series connectors.

## ■ Absolute Maximum Ratings (Ta = 25°C)

| Item                  | Symbol                    | Rated value                      |
|-----------------------|---------------------------|----------------------------------|
| Emitter               | Forward current           | I <sub>F</sub> 50 mA (see note)  |
|                       | Pulse forward current     | I <sub>FP</sub> ---              |
|                       | Reverse voltage           | V <sub>R</sub> 4 V               |
| Detector              | Collector–Emitter voltage | V <sub>CEO</sub> 30 V            |
|                       | Emitter–Collector voltage | V <sub>ECO</sub> 5 V             |
|                       | Collector current         | I <sub>C</sub> 20 mA             |
|                       | Collector dissipation     | P <sub>C</sub> 100 mW (see note) |
|                       | Ambient temperature       | Operating                        |
|                       | Storage                   | T <sub>stg</sub> –40°C to 100°C  |
| Soldering temperature | T <sub>sol</sub>          | ---                              |

**Note:** Refer to the temperature rating chart if the ambient temperature exceeds 25°C.

## ■ Electrical and Optical Characteristics (Ta = 25°C)

| Item         | Symbol                               | Value                                   | Condition  |   |
|--------------|--------------------------------------|---|--|---|
| Emitter      | Forward voltage                      | V <sub>F</sub> 1.2 V typ., 1.5 V max.   | I <sub>F</sub> = 30 mA   |   |
|              | Reverse current                      | I <sub>R</sub> 0.01 μA typ., 10 μA max. | V <sub>R</sub> = 4 V   |   |
|              | Peak emission wavelength             | λ <sub>P</sub> 940 nm typ.              | I <sub>F</sub> = 30 mA   |   |
| Detector     | Light current                        | I <sub>L</sub> 0.6 mA min., 14 mA max.  | I <sub>F</sub> = 20 mA, V <sub>CE</sub> = 5 V                        |   |
|              | Dark current                         | I <sub>D</sub> 200 nA max.              | V <sub>CE</sub> = 10 V, 0 lx   |   |
|              | Leakage current                      | I <sub>LEAK</sub> ---                   | ---  |   |
|              | Collector–Emitter saturated voltage  | V <sub>CE</sub> (sat)                   | 0.1 V typ., 0.4 V max.   | I <sub>F</sub> = 20 mA, I <sub>L</sub> = 0.3 mA |
|              | Peak spectral sensitivity wavelength | λ <sub>P</sub> 850 nm typ.              | V <sub>CE</sub> = 5 V  |   |
| Rising time  | t <sub>r</sub>                       | 8 μs typ.                               | V <sub>CC</sub> = 5 V, R <sub>L</sub> = 100 Ω, I <sub>L</sub> = 1 mA |   |
| Falling time | t <sub>f</sub>                       | 8 μs typ.                               | V <sub>CC</sub> = 5 V, R <sub>L</sub> = 100 Ω, I <sub>L</sub> = 1 mA |   |

■ Engineering Data

Forward Current vs. Collector Dissipation Temperature Rating

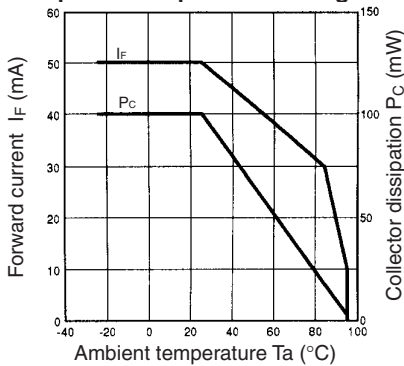

Forward Current vs. Forward Voltage Characteristics (Typical)

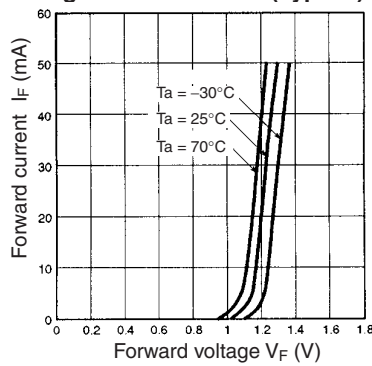

Light Current vs. Forward Current Characteristics (Typical)

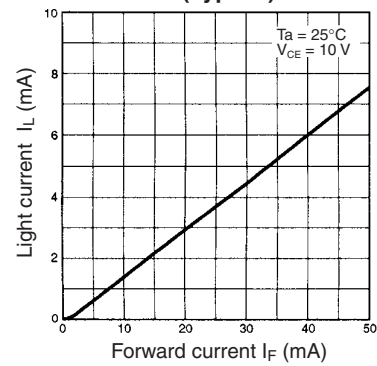

Light Current vs. Collector-Emitter Voltage Characteristics (Typical)

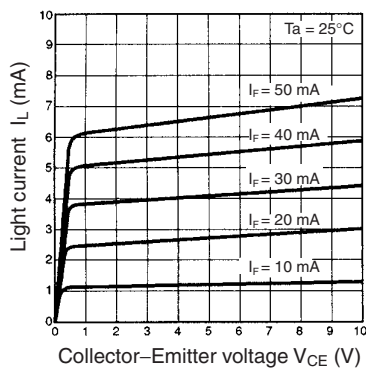

Relative Light Current vs. Ambient Temperature Characteristics (Typical)

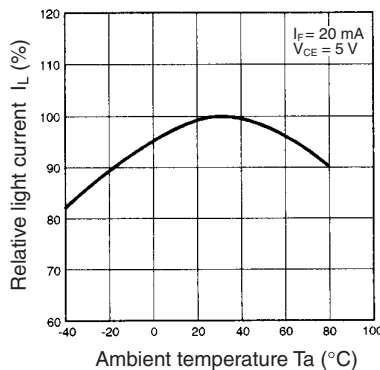

Dark Current vs. Ambient Temperature Characteristics (Typical)

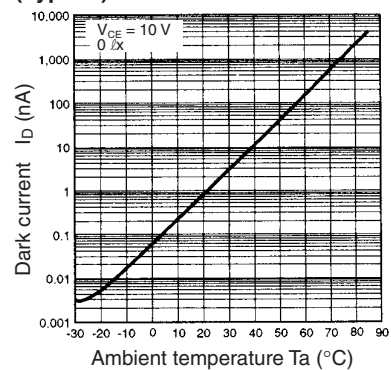

Response Time vs. Load Resistance Characteristics (Typical)

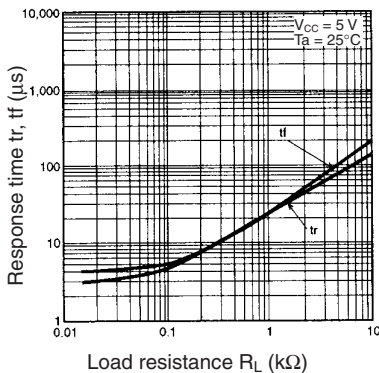

Sensing Position Characteristics (Typical)

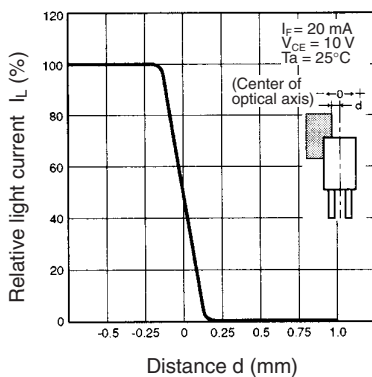

Sensing Position Characteristics (Typical)

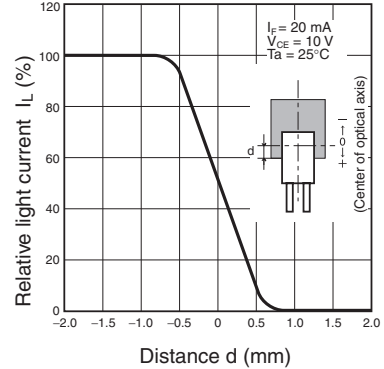

Response Time Measurement Circuit

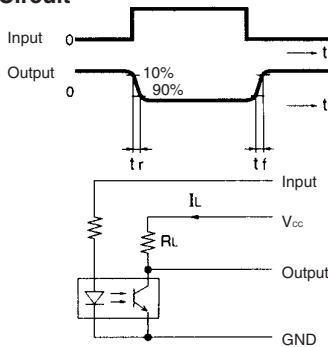

Refer to EE-SX4235A-P2 on page 140.