

*Phase leg
NPT IGBT Power Module*

$V_{CES} = 1200V$
 $I_C = 150A @ T_c = 80^\circ C$

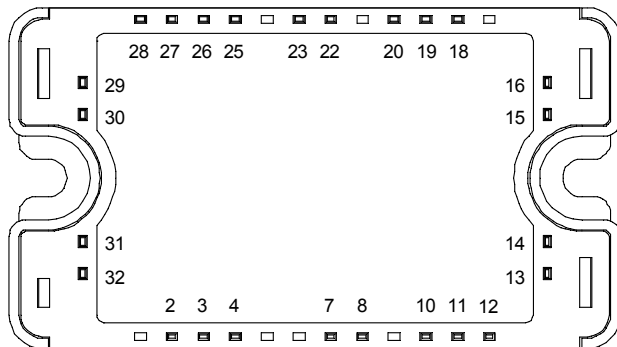
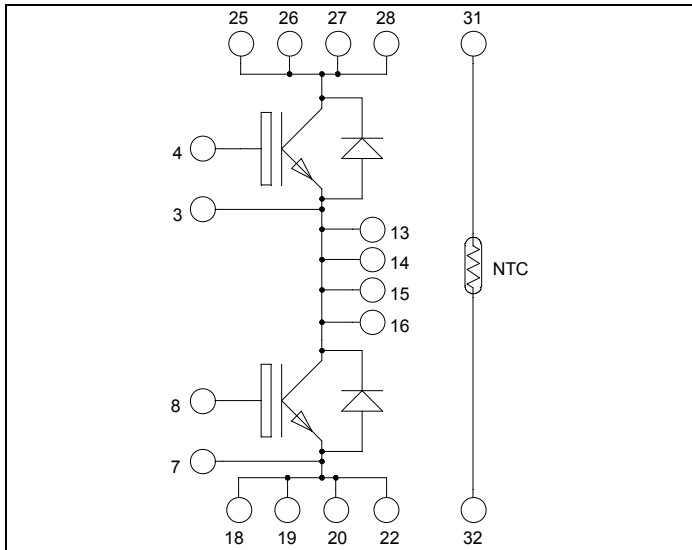

Pins 25/26/27/28 must be shorted together
 Pins 13/14/15/16 must be shorted together
 Pins 18/19/20/22 must be shorted together

Application

- Welding converters

Features

- Non Punch Through (NPT) Fast IGBT
 - Low voltage drop
 - Low tail current
 - Switching frequency up to 50 kHz
 - Soft recovery parallel diodes
 - Low diode VF
 - Low leakage current
 - RBSOA and SCSOA rated
- Kelvin emitter for easy drive
- Very low stray inductance
- High level of integration
- Internal thermistor for temperature monitoring

Benefits

- Outstanding performance at high frequency operation
- Direct mounting to heatsink (isolated package)
- Low junction to case thermal resistance
- Solderable terminals both for power and signal for easy PCB mounting
- Low profile
- Easy paralleling due to positive T_C of V_{CEsat}
- RoHS compliant

Absolute maximum ratings

Symbol	Parameter	Max ratings	Unit
V_{CES}	Collector - Emitter Breakdown Voltage	1200	V
I_C	Continuous Collector Current	$T_C = 25^\circ C$	210
		$T_C = 80^\circ C$	150
I_{CM}	Pulsed Collector Current	$T_C = 25^\circ C$	300
V_{GE}	Gate - Emitter Voltage	± 20	V
P_D	Maximum Power Dissipation	$T_C = 25^\circ C$	961
RBSOA	Reverse Bias Safe Operating Area	$T_J = 150^\circ C$	300A @ 1150V

CAUTION: These Devices are sensitive to Electrostatic Discharge. Proper Handling Procedures Should Be Followed. See application note APT0502 on www.microsemi.com

All ratings @ $T_j = 25^\circ\text{C}$ unless otherwise specified

Electrical Characteristics

Symbol	Characteristic	Test Conditions	Min	Typ	Max	Unit
I_{CES}	Zero Gate Voltage Collector Current	$V_{GE} = 0V, V_{CE} = 1200V$			250	μA
$V_{CE(sat)}$	Collector Emitter Saturation Voltage	$V_{GE} = 15V$ $I_C = 150A$	$T_j = 25^\circ\text{C}$	3.2	3.7	V
			$T_j = 125^\circ\text{C}$	3.9		
$V_{GE(th)}$	Gate Threshold Voltage	$V_{GE} = V_{CE}, I_C = 6mA$	4.5	5.5	6.5	V
I_{GES}	Gate – Emitter Leakage Current	$V_{GE} = 20V, V_{CE} = 0V$			400	nA

Dynamic Characteristics

Symbol	Characteristic	Test Conditions	Min	Typ	Max	Unit
C_{ies}	Input Capacitance	$V_{GE} = 0V$		9.3		nF
C_{oes}	Output Capacitance	$V_{CE} = 25V$		1.4		
C_{res}	Reverse Transfer Capacitance	$f = 1MHz$		0.7		
Q_G	Gate charge	$V_{GE} = \pm 15V; V_{CE} = 600V$ $I_C = 150A$		1.6		μC
$T_{d(on)}$	Turn-on Delay Time	Inductive Switching (25°C) $V_{GE} = \pm 15V$ $V_{Bus} = 600V$ $I_C = 150A$ $R_G = 5.6\Omega$		120		ns
T_r	Rise Time			50		
$T_{d(off)}$	Turn-off Delay Time			310		
T_f	Fall Time			20		
$T_{d(on)}$	Turn-on Delay Time	Inductive Switching (125°C) $V_{GE} = \pm 15V$ $V_{Bus} = 600V$ $I_C = 150A$ $R_G = 5.6\Omega$		130		ns
T_r	Rise Time			60		
$T_{d(off)}$	Turn-off Delay Time			360		
T_f	Fall Time			30		
E_{on}	Turn-on Switching Energy	$V_{GE} = \pm 15V$ $V_{Bus} = 600V$ $I_C = 150A$ $R_G = 5.6\Omega$	$T_j = 125^\circ\text{C}$	18		mJ
E_{off}	Turn-off Switching Energy		$T_j = 125^\circ\text{C}$	8		
I_{sc}	Short Circuit data	$V_{GE} \leq 15V; V_{Bus} = 900V$ $t_p \leq 10\mu\text{s}; T_j = 125^\circ\text{C}$		900		A

Reverse diode ratings and characteristics

Symbol	Characteristic	Test Conditions	Min	Typ	Max	Unit
V_{RRM}	Maximum Peak Repetitive Reverse Voltage		1200			V
I_{RM}	Maximum Reverse Leakage Current	$V_R = 1200V$	$T_j = 25^\circ\text{C}$		100	μA
			$T_j = 125^\circ\text{C}$		500	
I_F	DC Forward Current			100		A
V_F	Diode Forward Voltage	$I_F = 100A$		2.4	3	V
		$I_F = 200A$		2.7		
		$I_F = 100A$	$T_j = 125^\circ\text{C}$	1.8		
t_{rr}	Reverse Recovery Time	$I_F = 100A$ $V_R = 800V$ $di/dt = 200A/\mu\text{s}$	$T_j = 25^\circ\text{C}$	385		ns
			$T_j = 125^\circ\text{C}$	480		
Q_{rr}	Reverse Recovery Charge		$T_j = 25^\circ\text{C}$	1055		nC
			$T_j = 125^\circ\text{C}$	5240		

Temperature sensor NTC (see application note APT0406 on www.microsemi.com for more information).

Symbol	Characteristic	Min	Typ	Max	Unit
R ₂₅	Resistance @ 25°C		50		kΩ
ΔR ₂₅ /R ₂₅			5		%
B _{25/85}	T ₂₅ = 298.15 K		3952		K
ΔB/B	T _C = 100°C		4		%

$$R_T = \frac{R_{25}}{\exp\left[B_{25/85}\left(\frac{1}{T_{25}} - \frac{1}{T}\right)\right]}$$

T: Thermistor temperature
 R_T: Thermistor value at T

Thermal and package characteristics

Symbol	Characteristic	Min	Typ	Max	Unit	
R _{thJC}	Junction to Case thermal resistance	IGBT		0.13	°C/W	
		Diode		0.55		
V _{ISOL}	RMS Isolation Voltage, any terminal to case t = 1 min, I _{isol} < 1mA, 50/60Hz	2500			V	
T _J	Operating junction temperature range	-40		150	°C	
T _{STG}	Storage Temperature Range	-40		125		
T _C	Operating Case Temperature	-40		100		
Torque	Mounting torque	To heatsink	M4	2.5	4.7	N.m
Wt	Package Weight				110	g

SP3 Package outline (dimensions in mm)

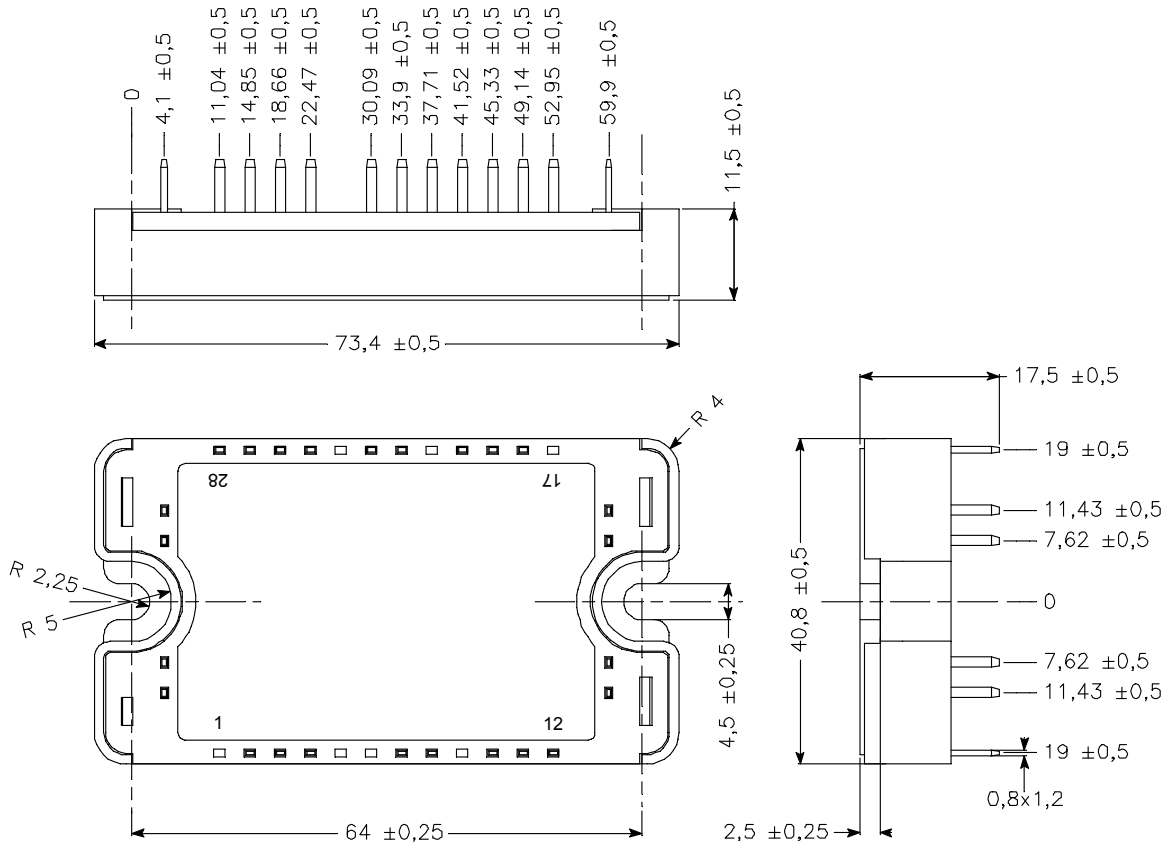

See application note 1901 - Mounting Instructions for SP3 Power Modules on www.microsemi.com

Typical Performance Curve

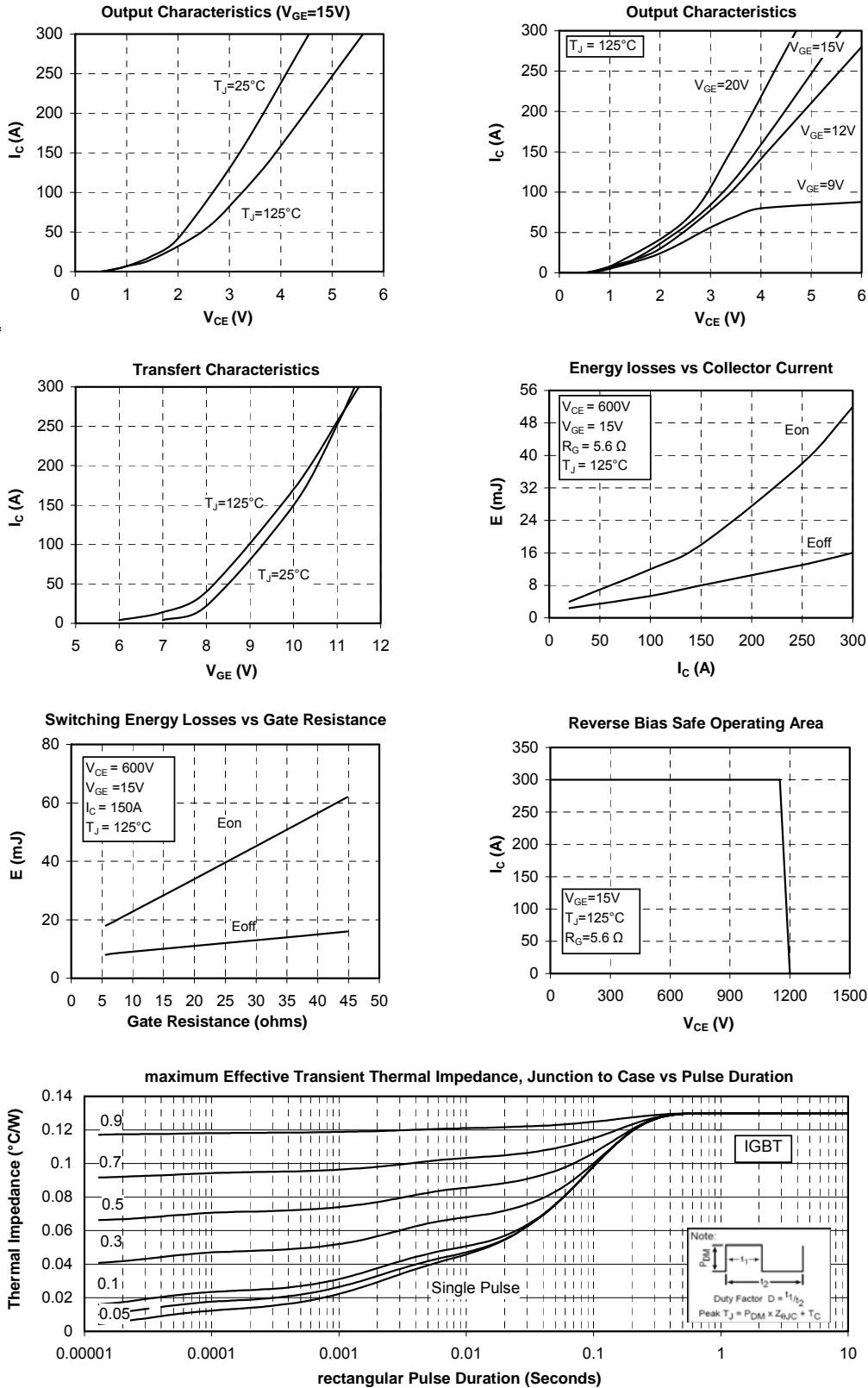

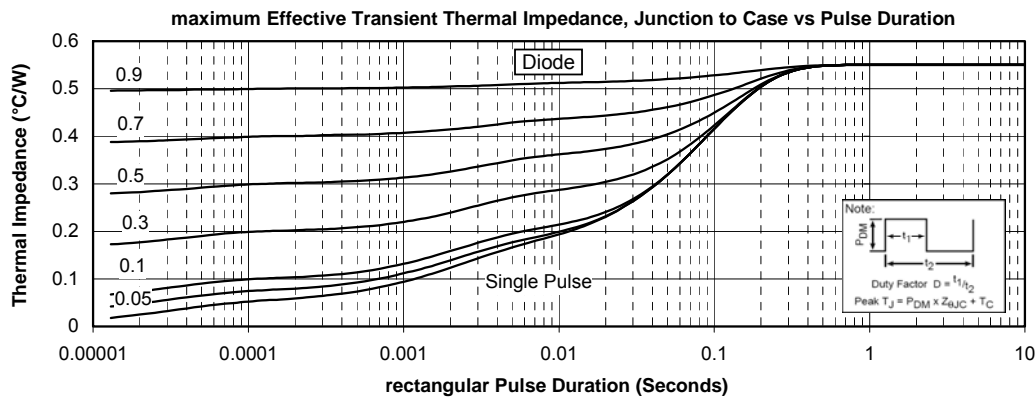
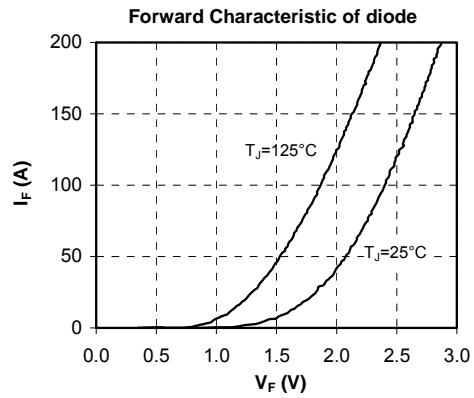
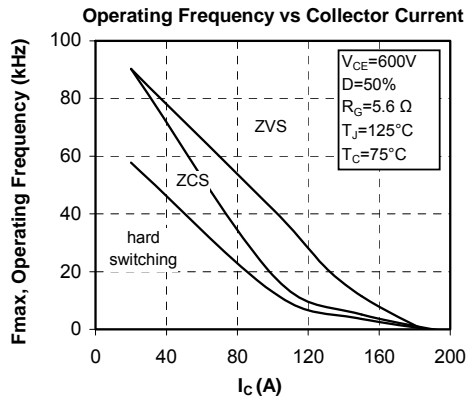

Microsemi reserves the right to change, without notice, the specifications and information contained herein

Microsemi's products are covered by one or more of U.S. patents 4,895,810 5,045,903 5,089,434 5,182,234 5,019,522 5,262,336 6,503,786 5,256,583 4,748,103 5,283,202 5,231,474 5,434,095 5,528,058 6,939,743 7,352,045 5,283,201 5,801,417 5,648,283 7,196,634 6,664,594 7,157,886 6,939,743 7,342,262 and foreign patents. U.S. and Foreign patents pending. All Rights Reserved.