

**Boost chopper + Full - Bridge
NPT & Trench + Field Stop IGBT
Power module**

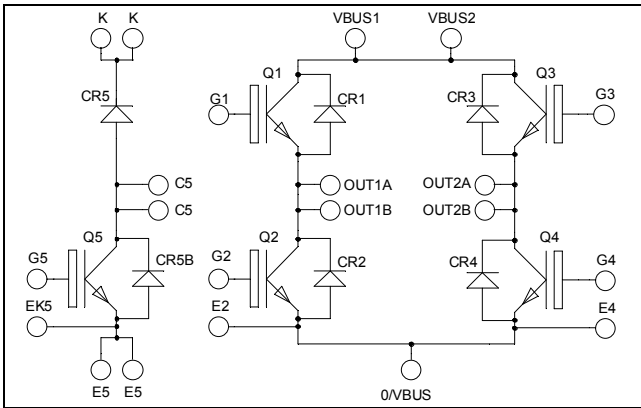

Full bridge top switches : Trench + Field Stop IGBT
 Full bridge bottom switches : FAST NPT IGBT
 Q5 boost chopper : FAST NPT IGBT

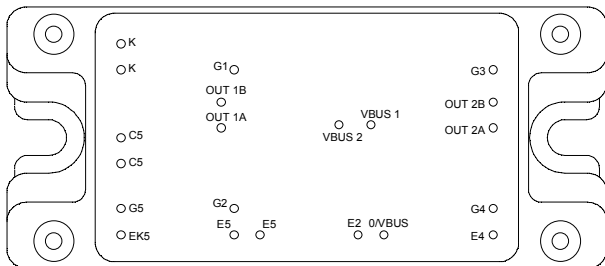

All multiple inputs and outputs must be shorted together
 OUT1A/OUT1B ; VBUS1/VBUS2 ; K/K ; ...

Trench & Field Stop IGBT Q1, Q3:
 $V_{CES} = 1200V$, $I_C = 25A$ @ $T_c = 80^\circ C$

Fast NPT IGBT Q2, Q4:
 $V_{CES} = 1200V$; $I_C = 25A$ @ $T_c = 80^\circ C$

Fast NPT IGBT Q5:
 $V_{CES} = 1200V$; $I_C = 50A$ @ $T_c = 80^\circ C$

Application

- Solar converter

Features

- **Q2, Q4, Q5 (FAST Non Punch Through (NPT) IGBT)**
 - Switching frequency up to 100 kHz
 - RBSOA & SCSOA rated
 - Low tail current
- **Q1, Q3 (Trench & Field Stop IGBT)**
 - Low voltage drop
 - Switching frequency up to 20 kHz
 - RBSOA & SCSOA rated
 - Low tail current
- Kelvin emitter for easy drive
- Very low stray inductance
- High level of integration

Benefits

- Optimized conduction & switching losses
- Direct mounting to heatsink (isolated package)
- Low junction to case thermal resistance
- Solderable terminals both for power and signal for easy PCB mounting
- Low profile
- Easy paralleling due to positive T_c of V_{CEsat}
- RoHS Compliant

CAUTION: These Devices are sensitive to Electrostatic Discharge. Proper Handling Procedures Should Be Followed. See application note APT0502 on www.microsemi.com

All ratings @ $T_j = 25^\circ\text{C}$ unless otherwise specified

1. Full bridge top switches
1.1 Top Trench + Field Stop IGBT characteristics
Absolute maximum ratings

<i>Symbol</i>	<i>Parameter</i>		<i>Max ratings</i>	<i>Unit</i>
V_{CES}	Collector - Emitter Breakdown Voltage		1200	V
I_C	Continuous Collector Current	$T_C = 25^\circ\text{C}$	40	A
		$T_C = 80^\circ\text{C}$	25	
I_{CM}	Pulsed Collector Current	$T_C = 25^\circ\text{C}$	50	
V_{GE}	Gate - Emitter Voltage		± 20	V
P_D	Maximum Power Dissipation	$T_C = 25^\circ\text{C}$	156	W
RBSOA	Reverse Bias Safe Operation Area	$T_j = 125^\circ\text{C}$	50A @ 1150V	

Electrical Characteristics

<i>Symbol</i>	<i>Characteristic</i>	<i>Test Conditions</i>	<i>Min</i>	<i>Typ</i>	<i>Max</i>	<i>Unit</i>	
I_{CES}	Zero Gate Voltage Collector Current	$V_{GE} = 0\text{V}, V_{CE} = 1200\text{V}$			250	μA	
$V_{CE(sat)}$	Collector Emitter Saturation Voltage	$V_{GE} = 15\text{V}$		$T_j = 25^\circ\text{C}$	1.7	2.1	V
		$I_C = 25\text{A}$		$T_j = 125^\circ\text{C}$	2.0		
$V_{GE(th)}$	Gate Threshold Voltage	$V_{GE} = V_{CE}, I_C = 1\text{mA}$	5.0	5.8	6.5	V	
I_{GES}	Gate - Emitter Leakage Current	$V_{GE} = 20\text{V}, V_{CE} = 0\text{V}$			400	nA	

Dynamic Characteristics

<i>Symbol</i>	<i>Characteristic</i>	<i>Test Conditions</i>	<i>Min</i>	<i>Typ</i>	<i>Max</i>	<i>Unit</i>
C_{ies}	Input Capacitance	$V_{GE} = 0\text{V}, V_{CE} = 25\text{V}$ $f = 1\text{MHz}$		1800		pF
C_{res}	Reverse Transfer Capacitance			82		
$T_{d(on)}$	Turn-on Delay Time	Inductive Switching (25°C) $V_{GE} = \pm 15\text{V}$ $V_{Bus} = 600\text{V}$ $I_C = 25\text{A}$ $R_G = 27\Omega$		90		ns
T_r	Rise Time			30		
$T_{d(off)}$	Turn-off Delay Time			420		
T_f	Fall Time			70		
$T_{d(on)}$	Turn-on Delay Time	Inductive Switching (125°C) $V_{GE} = \pm 15\text{V}$ $V_{Bus} = 600\text{V}$ $I_C = 25\text{A}$ $R_G = 27\Omega$		90		ns
T_r	Rise Time			50		
$T_{d(off)}$	Turn-off Delay Time			520		
T_f	Fall Time			90		
E_{on}	Turn-on Switching Energy	$V_{GE} = \pm 15\text{V}$ $V_{Bus} = 600\text{V}$ $I_C = 25\text{A}$ $R_G = 27\Omega$	$T_j = 25^\circ\text{C}$	1.9		mJ
			$T_j = 125^\circ\text{C}$	2.5		
E_{off}	Turn-off Switching Energy	$I_C = 25\text{A}$ $R_G = 27\Omega$	$T_j = 25^\circ\text{C}$	1.9		
			$T_j = 125^\circ\text{C}$	2.9		
R_{thJC}	Junction to Case Thermal resistance				0.8	$^\circ\text{C}/\text{W}$

1.2 Top fast diode characteristics

<i>Symbol</i>	<i>Characteristic</i>	<i>Test Conditions</i>		<i>Min</i>	<i>Typ</i>	<i>Max</i>	<i>Unit</i>
V _{RRM}	Maximum Peak Repetitive Reverse Voltage			1200			V
I _{RM}	Maximum Reverse Leakage Current	V _R =1200V	T _j = 25°C			100	μA
			T _j = 125°C			500	
I _F	DC Forward Current	T _c = 80°C			25		A
V _F	Diode Forward Voltage	I _F = 25A			2.6	3.1	V
		I _F = 50A			3.2		
		I _F = 25A	T _j = 125°C		1.8		
t _{rr}	Reverse Recovery Time	I _F = 25A V _R = 667V di/dt = 200A/μs	T _j = 25°C		320		ns
			T _j = 125°C		360		
Q _{rr}	Reverse Recovery Charge	I _F = 25A V _R = 667V di/dt = 200A/μs	T _j = 25°C		480		nC
			T _j = 125°C		1800		
R _{thJC}	Junction to Case Thermal resistance					1.4	°C/W

2. Full bridge bottom switches

2.1 Bottom Fast NPT IGBT characteristics

Absolute maximum ratings

<i>Symbol</i>	<i>Parameter</i>	<i>Max ratings</i>	<i>Unit</i>
V _{CES}	Collector - Emitter Breakdown Voltage	1200	V
I _C	Continuous Collector Current	T _C = 25°C	40
		T _C = 80°C	25
I _{CM}	Pulsed Collector Current	T _C = 25°C	100
V _{GE}	Gate - Emitter Voltage	±20	V
P _D	Maximum Power Dissipation	T _C = 25°C	208
RBSOA	Reverse Bias Safe Operating Area	T _j = 125°C	50A@1150V

Electrical Characteristics

<i>Symbol</i>	<i>Characteristic</i>	<i>Test Conditions</i>	<i>Min</i>	<i>Typ</i>	<i>Max</i>	<i>Unit</i>	
I _{CES}	Zero Gate Voltage Collector Current	V _{GE} = 0V V _{CE} = 1200V	T _j = 25°C		250	μA	
			T _j = 125°C		500		
V _{CE(sat)}	Collector Emitter saturation Voltage	V _{GE} = 15V I _C = 25A	T _j = 25°C	2.5	3.2	3.7	V
			T _j = 125°C		4.0		
V _{GE(th)}	Gate Threshold Voltage	V _{GE} = V _{CE} , I _C = 1mA	4		6	V	
I _{GES}	Gate - Emitter Leakage Current	V _{GE} = 20V, V _{CE} = 0V			400	nA	

Dynamic Characteristics

<i>Symbol</i>	<i>Characteristic</i>	<i>Test Conditions</i>		<i>Min</i>	<i>Typ</i>	<i>Max</i>	<i>Unit</i>
C_{ies}	Input Capacitance	$V_{GE} = 0V$			1650		pF
C_{oes}	Output Capacitance	$V_{CE} = 25V$			250		
C_{res}	Reverse Transfer Capacitance	$f = 1MHz$			110		
Q_g	Total gate Charge	$V_{GE} = 15V$			160		nC
Q_{ge}	Gate – Emitter Charge	$V_{Bus} = 300V$			10		
Q_{gc}	Gate – Collector Charge	$I_C = 25A$			70		
$T_{d(on)}$	Turn-on Delay Time	Inductive Switching (25°C)			60		ns
T_r	Rise Time	$V_{GE} = 15V$			50		
$T_{d(off)}$	Turn-off Delay Time	$V_{Bus} = 400V$			305		
T_f	Fall Time	$I_C = 25A$ $R_G = 22\Omega$			30		
$T_{d(on)}$	Turn-on Delay Time	Inductive Switching (125°C)			60		ns
T_r	Rise Time	$V_{GE} = 15V$			50		
$T_{d(off)}$	Turn-off Delay Time	$V_{Bus} = 400V$			346		
T_f	Fall Time	$I_C = 25A$ $R_G = 22\Omega$			40		
E_{on}	Turn-on Switching Energy	$V_{GE} = 15V$ $V_{Bus} = 400V$	$T_j = 125^\circ C$		3.5		mJ
E_{off}	Turn-off Switching Energy	$I_C = 25A$ $R_G = 22\Omega$	$T_j = 125^\circ C$		1.5		
R_{thJC}	Junction to Case Thermal resistance					0.6	°C/W

2.2 Bottom diode characteristics

<i>Symbol</i>	<i>Characteristic</i>	<i>Test Conditions</i>		<i>Min</i>	<i>Typ</i>	<i>Max</i>	<i>Unit</i>
V_{RRM}	Maximum Peak Repetitive Reverse Voltage			1200			V
I_{RM}	Maximum Reverse Leakage Current	$V_R = 1200V$	$T_j = 25^\circ C$			100	μA
			$T_j = 125^\circ C$			500	
I_F	DC Forward Current	$T_c = 80^\circ C$			25		A
V_F	Diode Forward Voltage	$I_F = 25A$			2.6	3.1	V
		$I_F = 50A$			3.2		
		$I_F = 25A$	$T_j = 125^\circ C$		1.8		
t_{rr}	Reverse Recovery Time	$I_F = 25A$	$T_j = 25^\circ C$		320		ns
			$T_j = 125^\circ C$		360		
Q_{rr}	Reverse Recovery Charge	$V_R = 667V$ $di/dt = 200A/\mu s$	$T_j = 25^\circ C$		480		nC
			$T_j = 125^\circ C$		1800		
R_{thJC}	Junction to Case Thermal resistance					1.4	°C/W

3. Boost chopper switches

3.1 Fast NPT IGBT characteristics

Absolute maximum ratings

Symbol	Parameter	Max ratings	Unit
V_{CES}	Collector - Emitter Breakdown Voltage	1200	V
I_C	Continuous Collector Current	$T_c = 25^\circ\text{C}$	70
		$T_c = 80^\circ\text{C}$	50
I_{CM}	Pulsed Collector Current	$T_c = 25^\circ\text{C}$	150
V_{GE}	Gate - Emitter Voltage	± 20	V
P_D	Maximum Power Dissipation	$T_c = 25^\circ\text{C}$	312
RBSOA	Reverse Bias Safe Operating Area	$T_j = 150^\circ\text{C}$	100A @ 1200V

Electrical Characteristics

Symbol	Characteristic	Test Conditions	Min	Typ	Max	Unit
I_{CES}	Zero Gate Voltage Collector Current	$V_{GE} = 0\text{V}$			250	μA
		$V_{CE} = 1200\text{V}$			500	
$V_{CE(sat)}$	Collector Emitter saturation Voltage	$V_{GE} = 15\text{V}$		3.2	3.7	V
		$I_C = 50\text{A}$		4.0		
$V_{GE(th)}$	Gate Threshold Voltage	$V_{GE} = V_{CE}, I_C = 1\text{mA}$	4.5		6.5	V
I_{GES}	Gate - Emitter Leakage Current	$V_{GE} = 20\text{V}, V_{CE} = 0\text{V}$			100	nA

Dynamic Characteristics

Symbol	Characteristic	Test Conditions	Min	Typ	Max	Unit
C_{ies}	Input Capacitance	$V_{GE} = 0\text{V}$		3450		pF
C_{oes}	Output Capacitance	$V_{CE} = 25\text{V}$		330		
C_{res}	Reverse Transfer Capacitance	$f = 1\text{MHz}$		220		
Q_g	Total gate Charge	$V_{GS} = 15\text{V}$		330		nC
Q_{ge}	Gate - Emitter Charge	$V_{Bus} = 600\text{V}$		35		
Q_{gc}	Gate - Collector Charge	$I_C = 50\text{A}$		200		
$T_{d(on)}$	Turn-on Delay Time	Inductive Switching (25°C) $V_{GE} = 15\text{V}$ $V_{Bus} = 600\text{V}$ $I_C = 50\text{A}$ $R_G = 5\ \Omega$		35		ns
T_r	Rise Time			65		
$T_{d(off)}$	Turn-off Delay Time			320		
T_f	Fall Time			30		
$T_{d(on)}$	Turn-on Delay Time	Inductive Switching (125°C) $V_{GE} = \pm 15\text{V}$ $V_{Bus} = 600\text{V}$ $I_C = 50\text{A}$ $R_G = 5\ \Omega$		35		ns
T_r	Rise Time			65		
$T_{d(off)}$	Turn-off Delay Time			360		
T_f	Fall Time			40		
E_{on}	Turn-on Switching Energy	$V_{GE} = \pm 15\text{V}$ $V_{Bus} = 600\text{V}$	$T_j = 125^\circ\text{C}$	6.9		mJ
E_{off}	Turn-off Switching Energy	$I_C = 50\text{A}$ $R_G = 5\ \Omega$	$T_j = 125^\circ\text{C}$	3.05		
R_{thJC}	Junction to Case Thermal resistance				0.4	$^\circ\text{C/W}$

3.2 Chopper diode characteristics

Symbol	Characteristic	Test Conditions		Min	Typ	Max	Unit
V _{RRM}	Maximum Peak Repetitive Reverse Voltage			1200			V
I _{RM}	Maximum Reverse Leakage Current	V _R =1200V	T _j = 25°C			100	μA
			T _j = 125°C			500	
I _F	DC Forward Current	T _c = 80°C			30		A
V _F	Diode Forward Voltage	I _F = 30A			2.6	3.1	V
		I _F = 60A			3.2		
		I _F = 30A	T _j = 125°C		1.8		
t _{rr}	Reverse Recovery Time	I _F = 30A V _R = 800V di/dt = 200A/μs	T _j = 25°C		300		ns
	T _j = 125°C			380			
Q _{rr}	Reverse Recovery Charge	I _F = 30A V _R = 800V di/dt = 200A/μs	T _j = 25°C		360		nC
			T _j = 125°C		1700		
R _{thJC}	Junction to Case Thermal resistance					1.2	°C/W

4. Package characteristics

Symbol	Characteristic	Min	Typ	Max	Unit	
V _{ISOL}	RMS Isolation Voltage, any terminal to case t=1 min, I isol<1mA, 50/60Hz	2500			V	
T _J	Operating junction temperature range	-40		150*	°C	
T _{STG}	Storage Temperature Range	-40		125		
T _C	Operating Case Temperature	-40		100		
Torque	Mounting torque	To heatsink	M5	2.5	4.7	N.m
Wt	Package Weight				160	g

* T_j=175°C for Trench & Field Stop IGBT

5. SP4 Package outline (dimensions in mm)

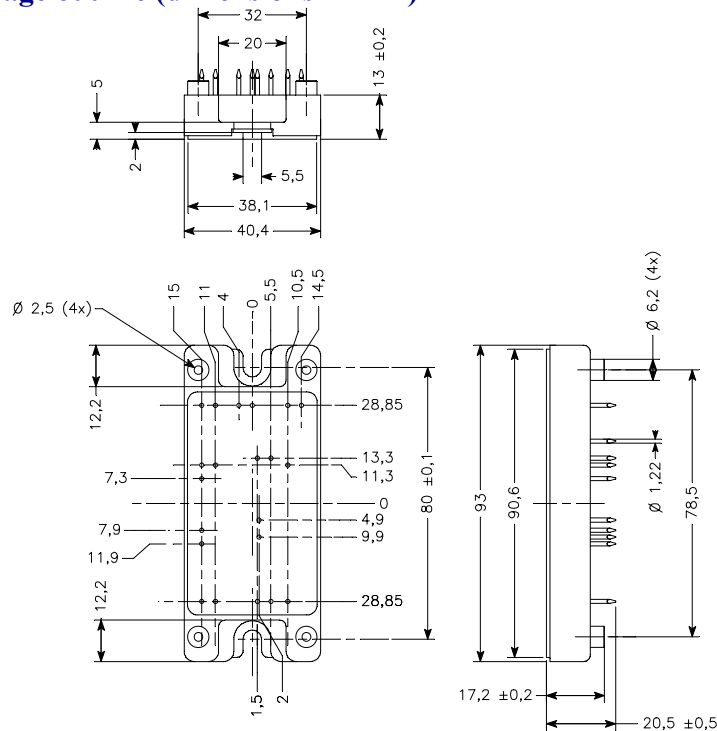

See application note APT0501 - Mounting Instructions for SP4 Power Modules on www.microsemi.com

6. Full bridge top switches curves

6.1 Top Trench + Field Stop IGBT typical performance curves

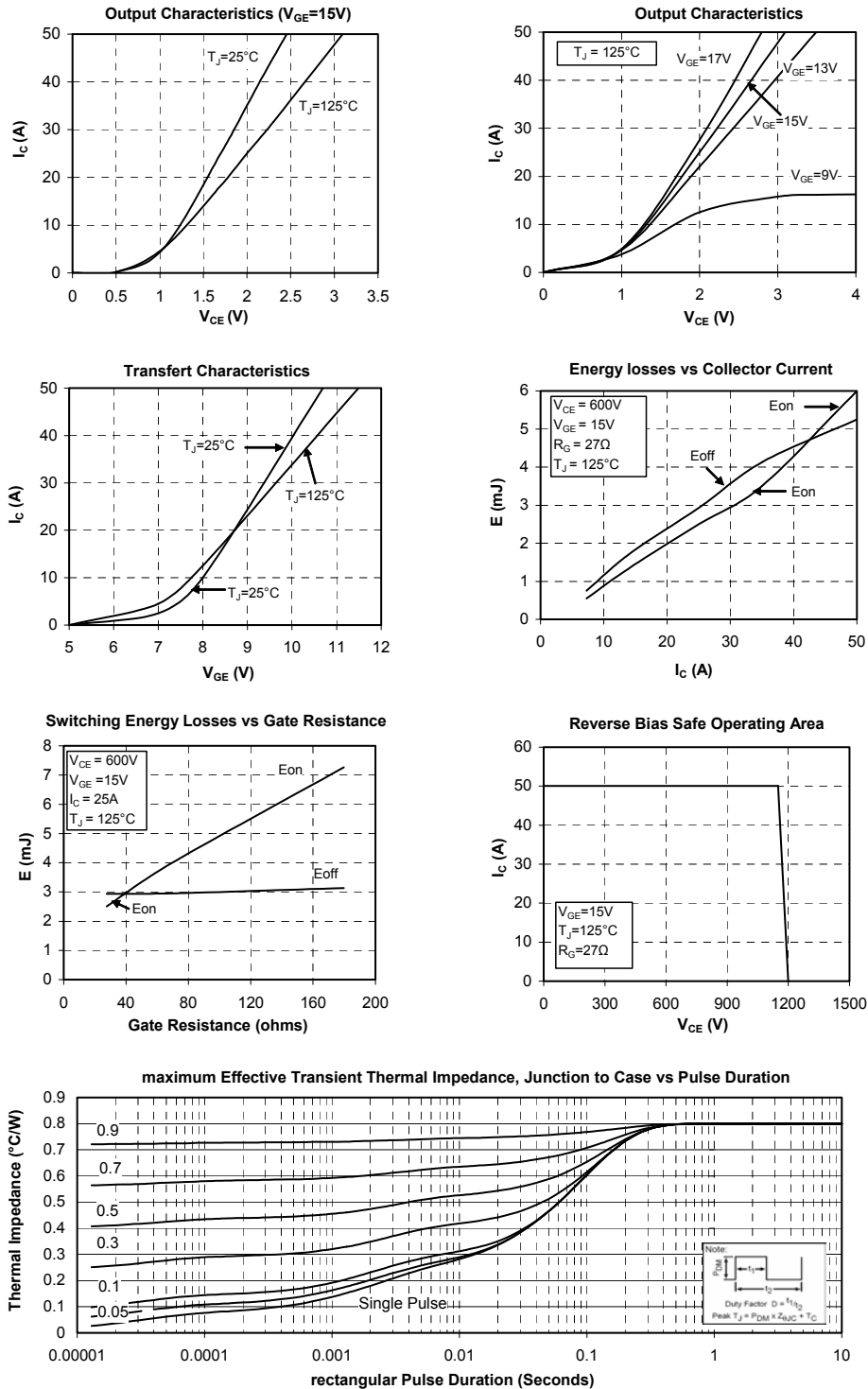

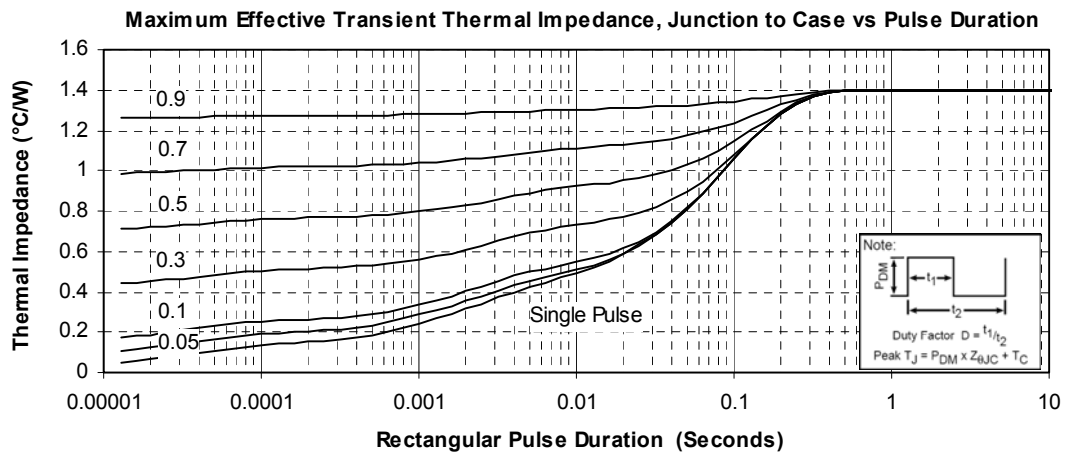
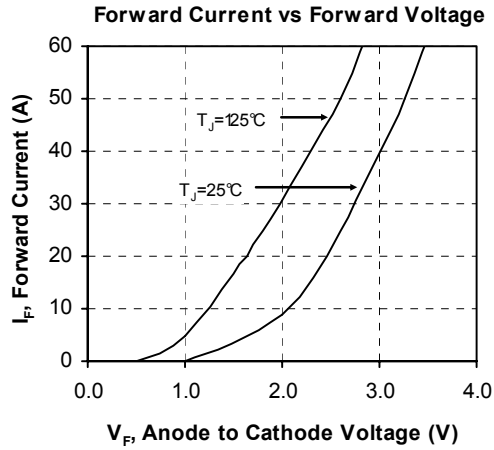
6.2 Top Fast diode typical performance curves

7. Full bridge bottom switches curves

7.1 Bottom fast NPT IGBT typical performance curves

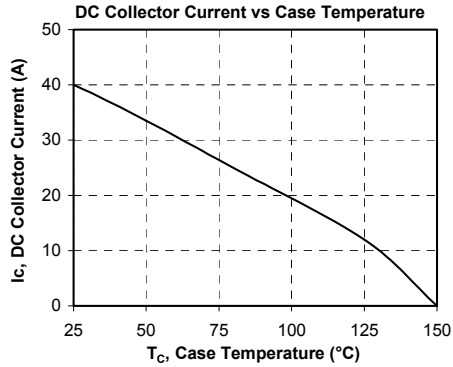
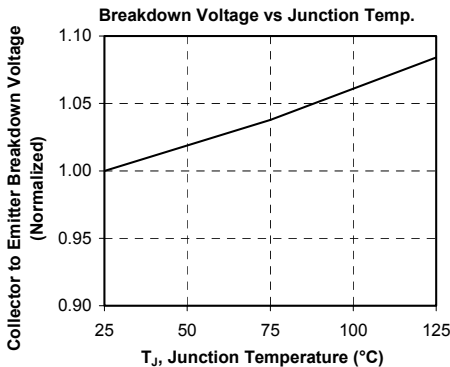
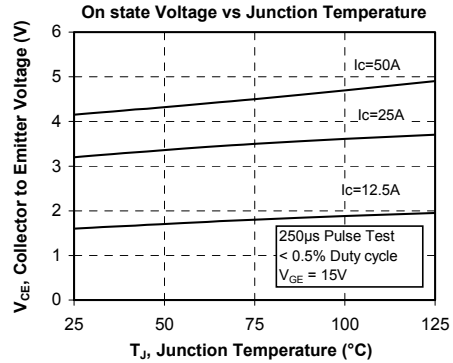
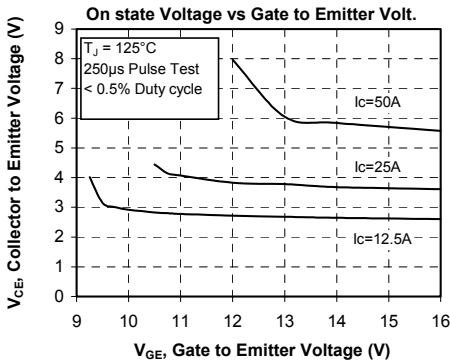
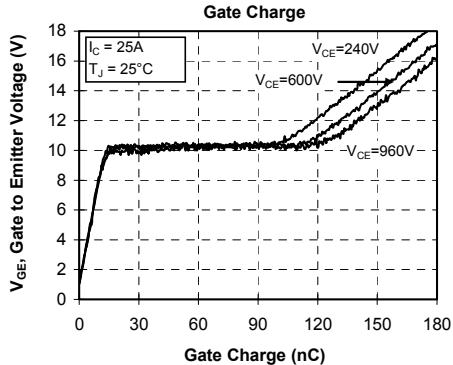
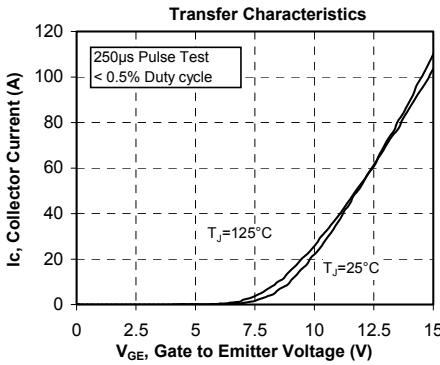
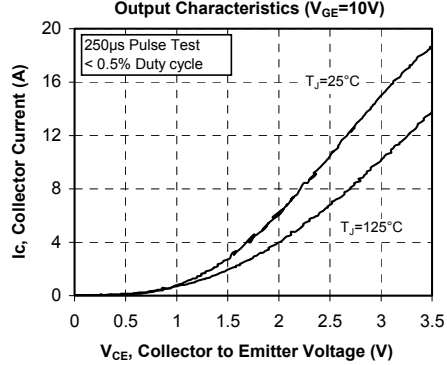
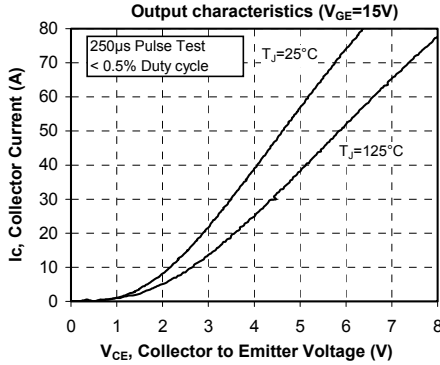

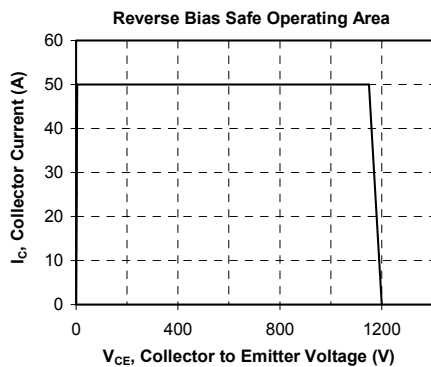
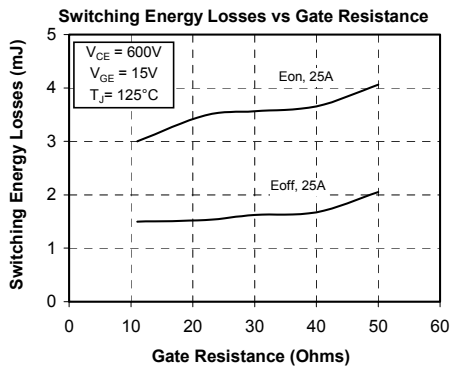
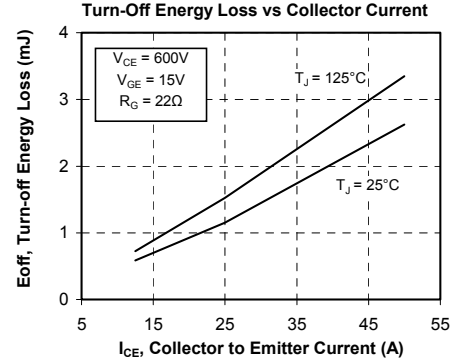
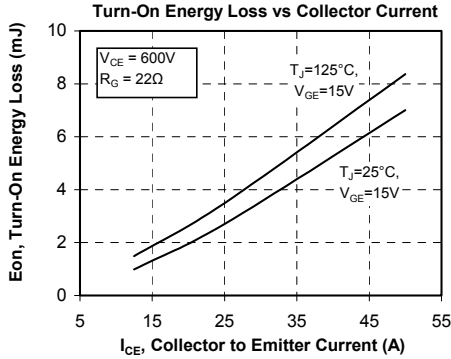
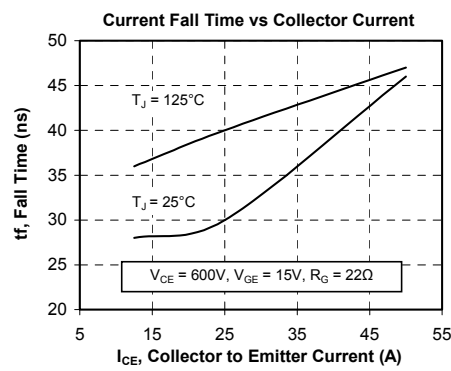
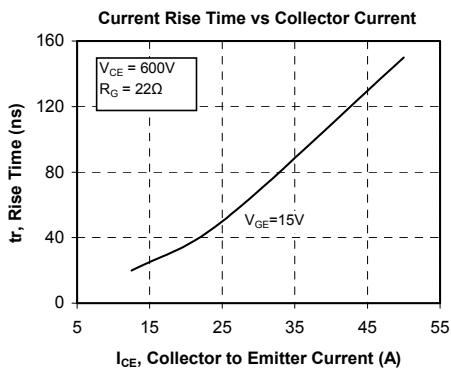
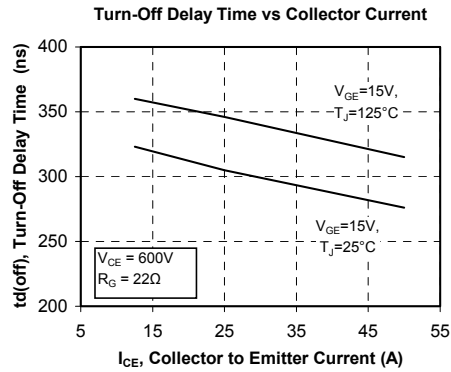
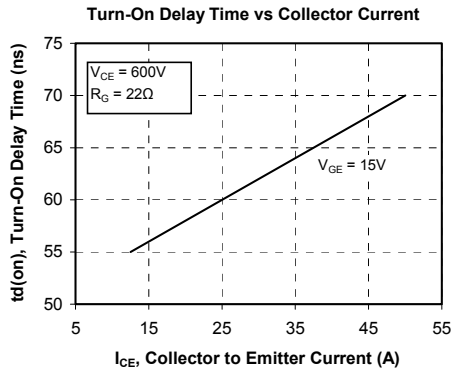

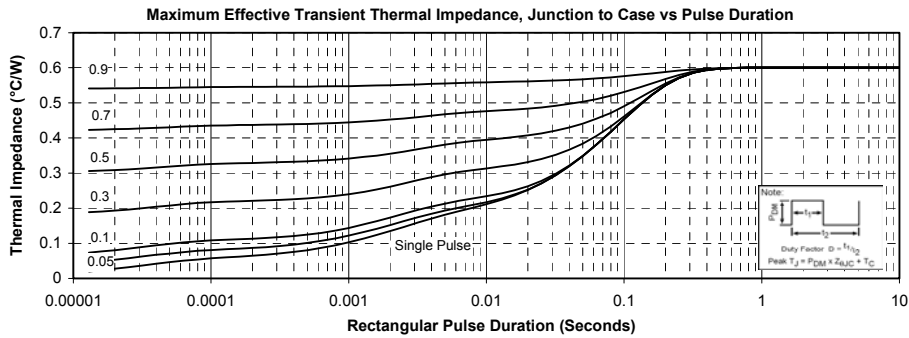
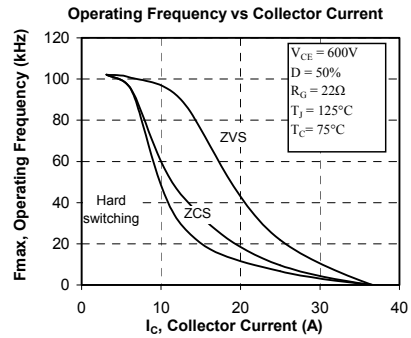
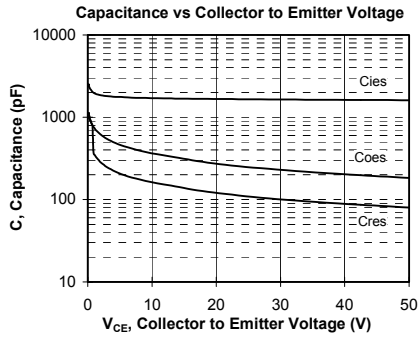

7.2 Bottom diode typical performance curves

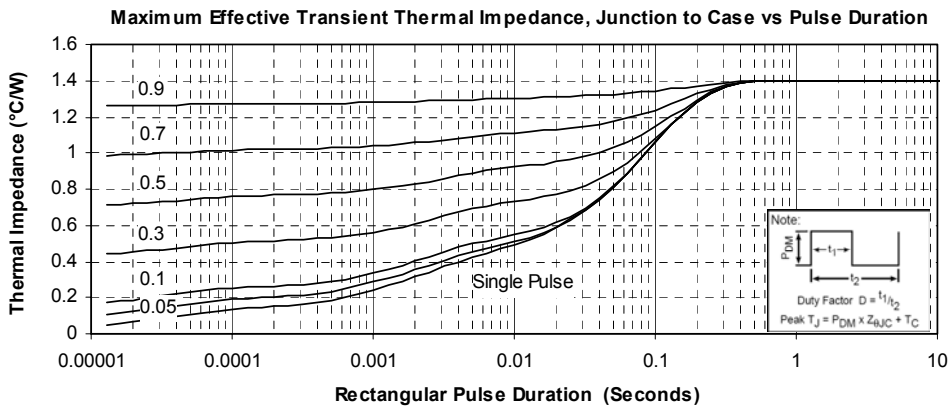
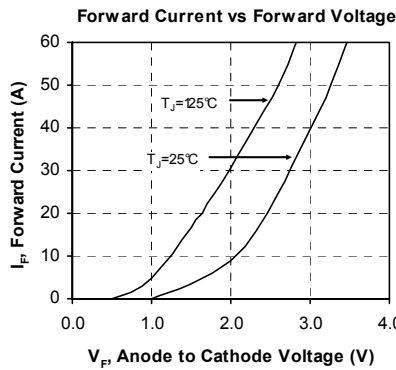

8. Boost chopper switches curves

8.1 Fast NPT IGBT typical performance curves

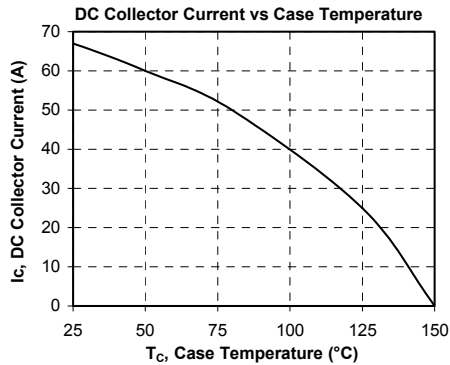
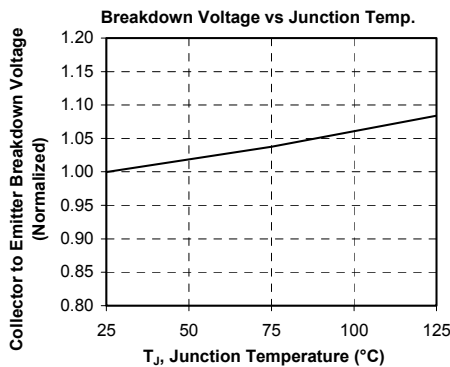
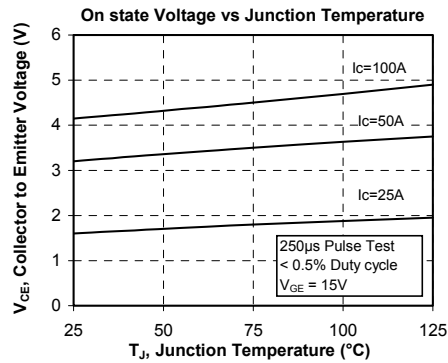
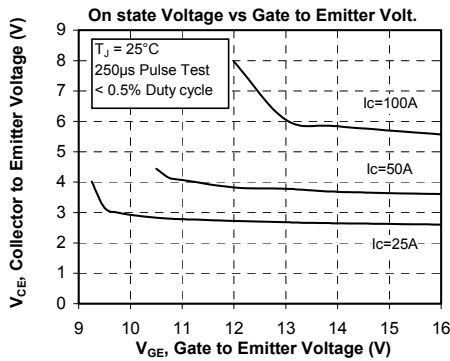
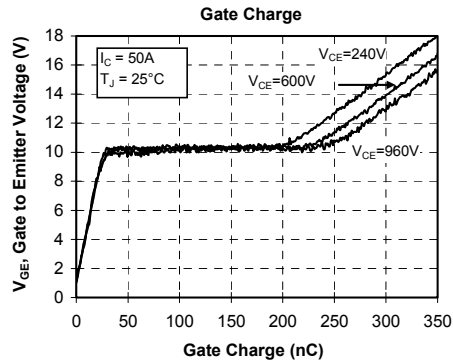
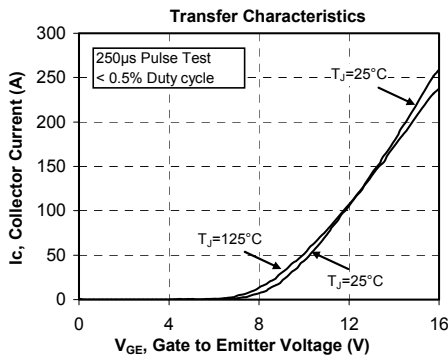
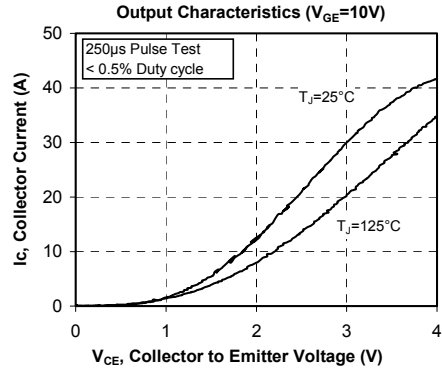
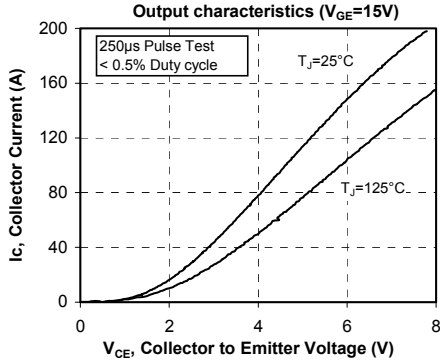

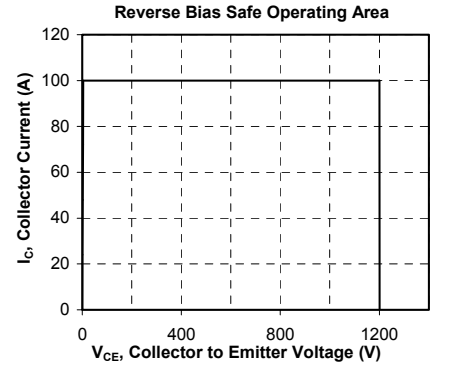
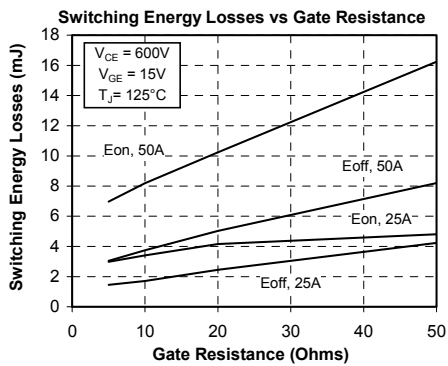
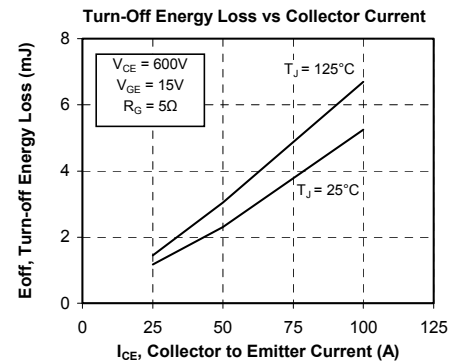
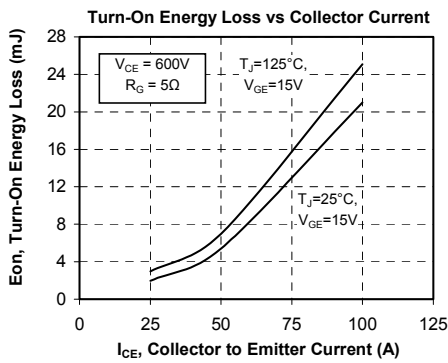
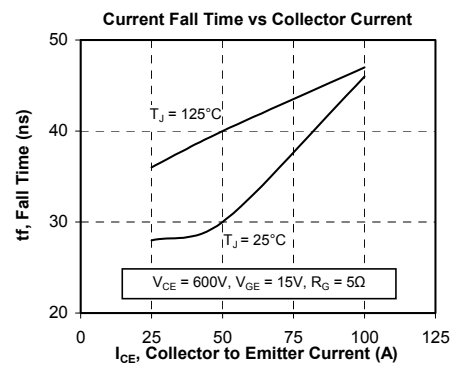
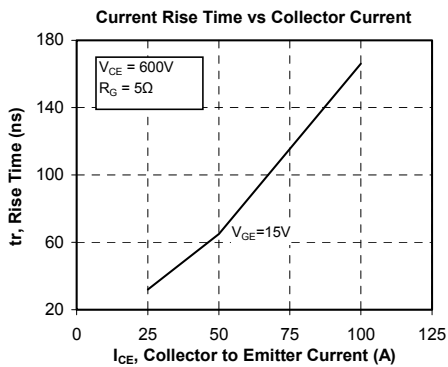
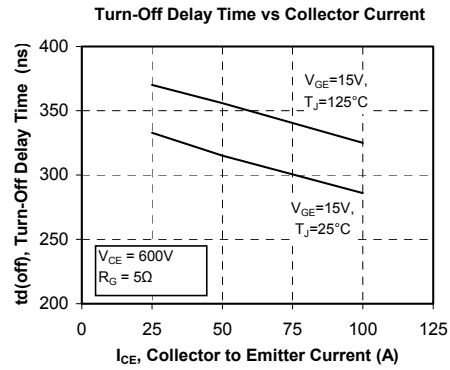
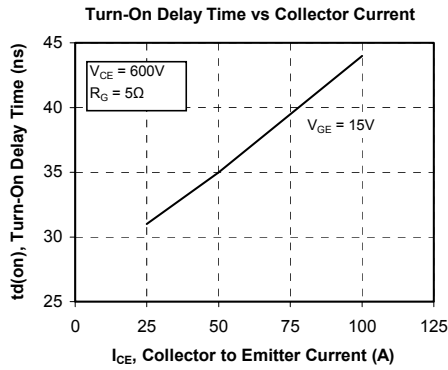

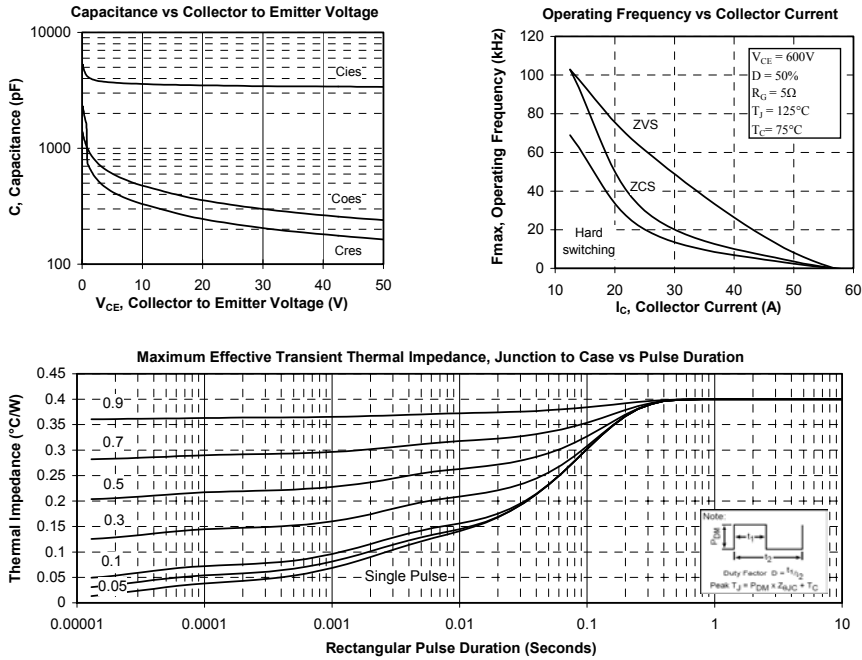

8.2 Chopper diode typical performance curves

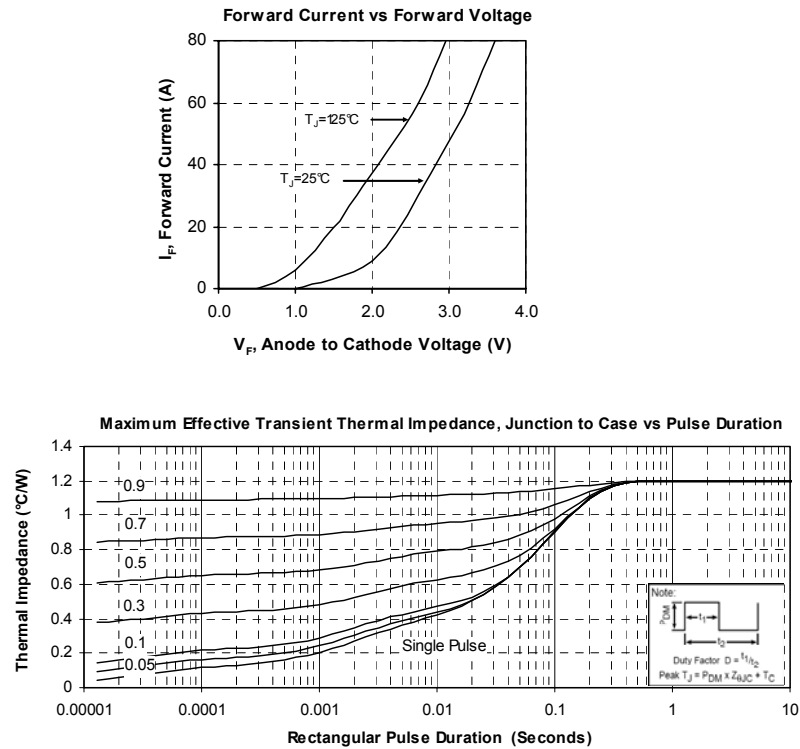

Microsemi reserves the right to change, without notice, the specifications and information contained herein

Microsemi's products are covered by one or more of U.S. patents 4,895,810 5,045,903 5,089,434 5,182,234 5,019,522 5,262,336 6,503,786 5,256,583 4,748,103 5,283,202 5,231,474 5,434,095 5,528,058 and foreign patents. U.S. and Foreign patents pending. All Rights Reserved.