

Split Dual SCR POW-R-BLOK™ Modules 20 Amperes/800 Volts

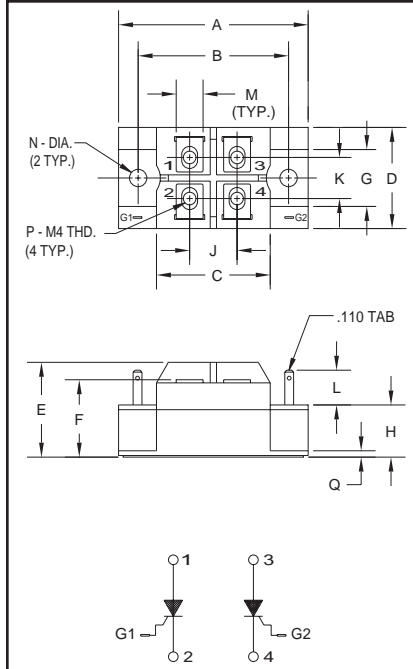

Outline Drawing

| Dimension | Inches | Millimeters |
|-----------|------------|-------------|
| A | 2.362 Max. | 60 Max. |
| B | 1.874 | 47.6 |
| C | 1.417 | 36 |
| D | 1.260 Max. | 32 Max. |
| E | 1.181 Max. | 30 Max. |
| F | 0.964 | 24.5 |
| G | 0.703 | 18 |
| H | 0.650 | 16.5 |
| J | 0.591 | 15 |
| K | 0.512 | 13 |
| L | 0.433 | 11 |
| M | 0.335 | 8.5 |
| N | 0.216 Dia. | Dia. 5.5 |
| P | M4 Metric | M4 |
| Q | 0.079 | 2 |



CT230802
Split Dual SCR
POW-R-BLOK™ Modules
20 Amperes/800 Volts

Description:

Powerex Split Dual SCR POW-R-BLOK™ Modules are designed for use in applications requiring control and rectification. The modules are isolated for easy mounting with other components on common heatsinks.

Features:

- Isolated Mounting
- Glass Passivated Chips
- Metal Baseplate
- Low Thermal Impedance
- Four Terminal Flexibility

Applications:

- Battery Supplies
- Contactless Switches
- Furnace Control
- Light Dimmers

Ordering Information:

Select the complete eight digit module part number you desire from the table below.

Example: CT230802 is a 800 Volt, 20 Ampere Split Dual SCR POW-R-BLOK™ Module.

| Type | Voltage Volts (x100) | Current Rating Amperes (x10) |
|------|-------------------------|---------------------------------|
| CT23 | 08 | 02 |

CT230802

Split Dual SCR POW-R-BLOK™ Modules

20 Amperes/800 Volts

Absolute Maximum Ratings

| Characteristics | Symbol | CT230802 | Units |
|---|-------------|------------|------------------|
| Peak Forward Blocking Voltage | V_{DRM} | 800 | Volts |
| Transient Peak Forward Blocking Voltage (Non-Repetitive), $t < 5ms$ | V_{DSM} | 960 | Volts |
| DC Forward Blocking Voltage | $V_{D(DC)}$ | 640 | Volts |
| Peak Reverse Blocking Voltage | V_{RRM} | 800 | Volts |
| Transient Peak Reverse Blocking Voltage (Non-Repetitive), $t < 5ms$ | V_{RSM} | 960 | Volts |
| DC Reverse Blocking Voltage | $V_{R(DC)}$ | 640 | Volts |
| RMS On-State Current | $I_T(RSM)$ | 30 | Amperes |
| Average On-State Current, $T_C = 87^\circ C$ | $I_T(AV)$ | 20 | Amperes |
| Peak One-Cycle Surge (Non-Repetitive) On-State Current (60Hz) | I_{TSM} | 400 | Amperes |
| Peak One-Cycle Surge (Non-Repetitive) On-State Current (50Hz) | I_{TSM} | 365 | Amperes |
| I^2t (for Fusing), 8.3 milliseconds | I^2t | 670 | A^2sec |
| Critical Rate-of-Rise of On-State Current* | di/dt | 100 | Amperes/ μs |
| Peak Gate Power Dissipation | P_{GM} | 5.0 | Watts |
| Average Gate Power Dissipation | $P_{G(AV)}$ | 0.5 | Watts |
| Peak Forward Gate Voltage | V_{GFM} | 10 | Volts |
| Peak Reverse Gate Voltage | V_{GRM} | 5.0 | Volts |
| Peak Forward Gate Current | I_{GFM} | 2.0 | Amperes |
| Storage Temperature | T_{STG} | -40 to 125 | $^\circ C$ |
| Operating Temperature | T_j | -40 to 125 | $^\circ C$ |
| Maximum Mounting Torque M5 Mounting Screw | — | 17 | in.-lb. |
| Maximum Mounting Torque M4 Terminal Screw | — | 12 | lb.-in. |
| Module Weight (Typical) | — | 80 | Grams |
| V Isolation | V_{RMS} | 2000 | Volts |

* $T_j = 125^\circ C$, $I_G = 0.5A$, $V_D = 1/2 V_{DRM}$

Electrical and Thermal Characteristics, $T_j = 25^\circ C$ unless otherwise specified

| Characteristics | Symbol | Test Conditions | CT230802 | Units |
|---|-------------------|--|----------|-----------------|
| Blocking State Maximums | | | | |
| Forward Leakage Current, Peak | I_{DRM} | $T_j = 125^\circ C$, $V_{DRM} = \text{Rated}$ | 4.0 | mA |
| Reverse Leakage Current, Peak | I_{RRM} | $T_j = 125^\circ C$, $V_{RRM} = \text{Rated}$ | 4.0 | mA |
| Conducting State Maximums | | | | |
| Peak On-State Voltage | V_{TM} | $I_{TM} = 60A$ | 1.8 | Volts |
| Switching Minimums | | | | |
| Critical Rate-of-Rise of Off-State Voltage | dv/dt | $T_j = 125^\circ C$, $V_D = 2/3 V_{DRM}$ | 500 | Volts/ μs |
| Thermal Maximums | | | | |
| Thermal Resistance, Junction-to-Case | $R_{\theta(J-C)}$ | Per Module | 1.0 | $^\circ C/Watt$ |
| Thermal Resistance, Case-to-Sink (Lubricated) | $R_{\theta(C-S)}$ | Per Module | 0.25 | $^\circ C/Watt$ |
| Gate Parameters Maximums | | | | |
| Gate Current-to-Trigger | I_{GT} | $V_D = 6V$, $R_L = 2\Omega$ | 50 | mA |
| Gate Voltage-to-Trigger | V_{GT} | $V_D = 6V$, $R_L = 2\Omega$ | 3.0 | Volts |
| Non-Triggering Gate Voltage | V_{GDM} | $T_j = 125^\circ C$, $V_D = 1/2 V_{DRM}$ | 0.25 | Volts |

CT230802
Split Dual SCR POW-R-BLOK™ Modules
 20 Amperes/800 Volts

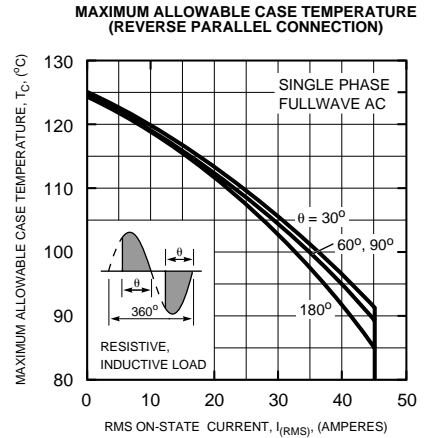
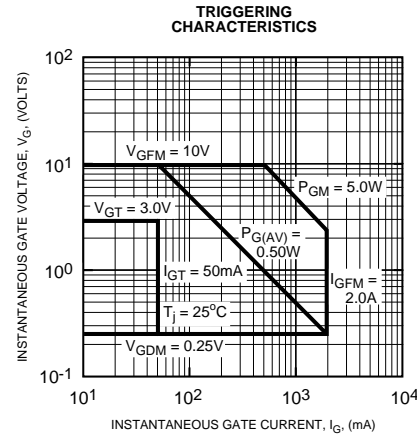
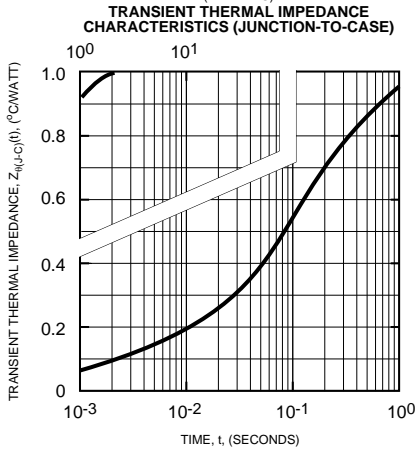
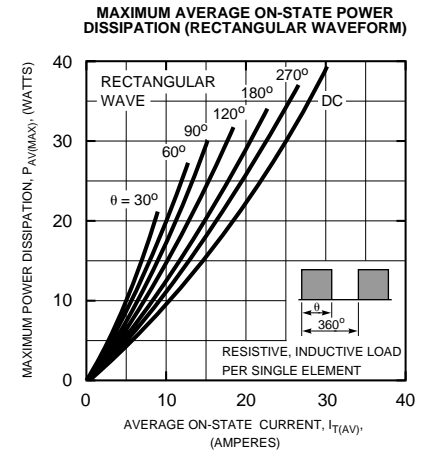
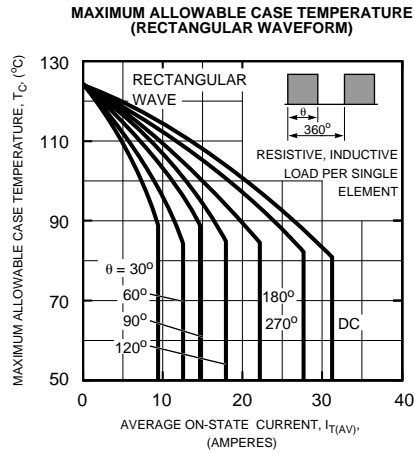
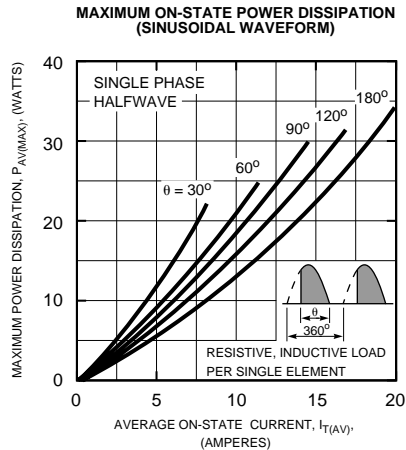
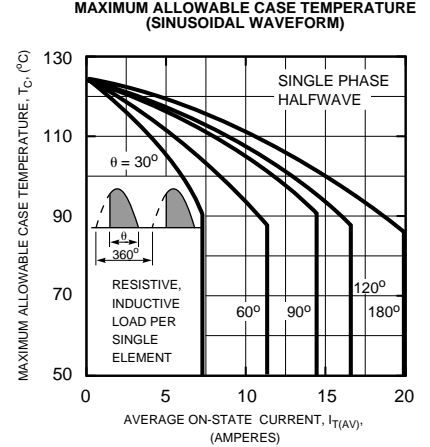
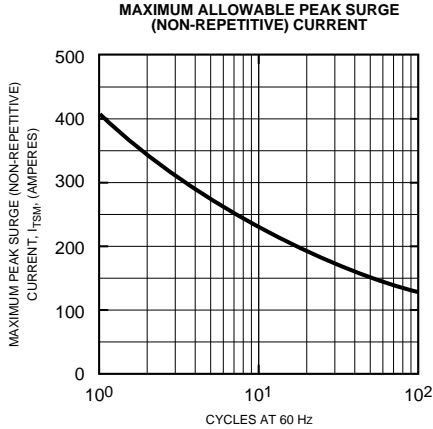
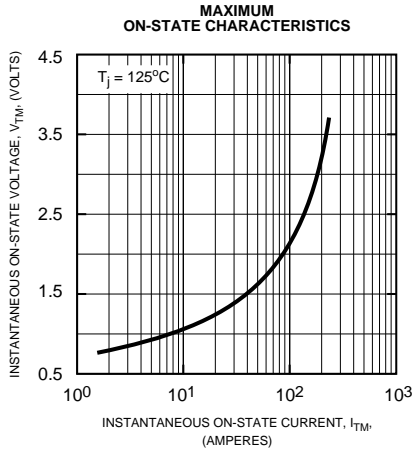

CT230802
Split Dual SCR POW-R-BLOK™ Modules
 20 Amperes/800 Volts

**MAXIMUM ON-STATE POWER DISSIPATION
 (REVERSE PARALLEL CONNECTION)**

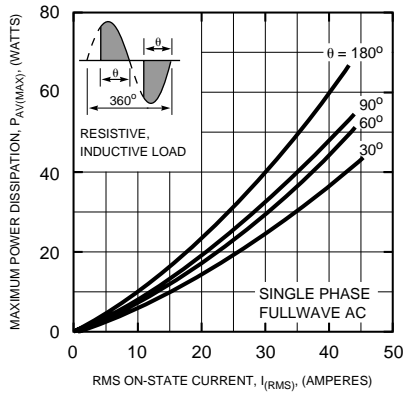

**MAXIMUM ALLOWABLE CASE TEMPERATURE
 (SINGLE PHASE BRIDGE CONNECTION)**

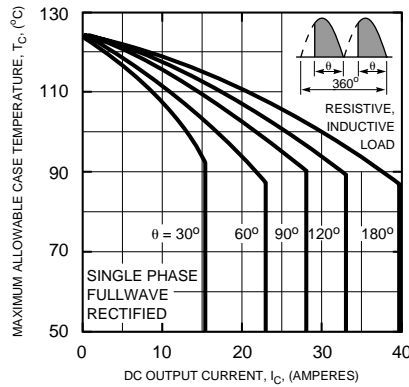

**MAXIMUM ON-STATE POWER DISSIPATION
 (SINGLE PHASE BRIDGE CONNECTION)**

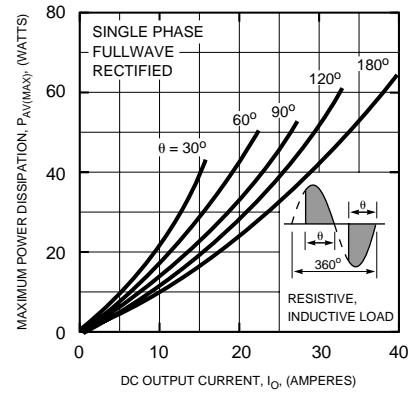

**MAXIMUM ALLOWABLE CASE TEMPERATURE
 (THREE PHASE BRIDGE CONNECTION)**

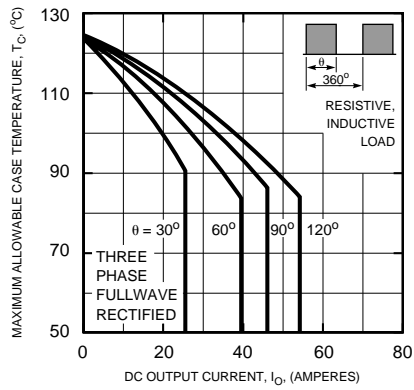

**MAXIMUM ON-STATE POWER DISSIPATION
 (THREE PHASE BRIDGE CONNECTION)**

