

Half Controlled Single Phase Rectifier Bridge with Freewheeling Diode

$I_{dAVM} = 32 \text{ A}$
 $V_{RRM} = 800-1600 \text{ V}$

V_{RSM} V_{DSM} V	V_{RRM} V_{DRM} V	Type
900	800	VHF 28-08io5
1300	1200	VHF 28-12io5
1500	1400	VHF 28-14io5
1700	1600	VHF 28-16io5

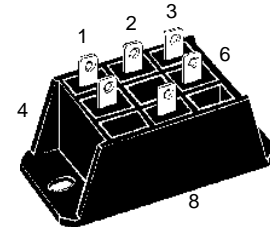
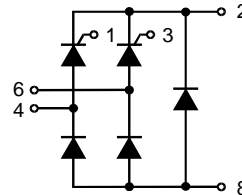

Symbol	Test Conditions	Maximum Ratings
I_{dAV} I_{dAVM} ① I_{FRMS} , I_{TRMS}	$T_K = 85^\circ\text{C}$, module module per leg	28 A 32 A 23 A
I_{FSM} , I_{TSM}	$T_{VJ} = 45^\circ\text{C}$; $V_R = 0 \text{ V}$ $t = 10 \text{ ms}$ (50 Hz), sine $t = 8.3 \text{ ms}$ (60 Hz), sine	300 A 330 A
	$T_{VJ} = T_{VJM}$ $V_R = 0 \text{ V}$ $t = 10 \text{ ms}$ (50 Hz), sine $t = 8.3 \text{ ms}$ (60 Hz), sine	270 A 300 A
I^2t	$T_{VJ} = 45^\circ\text{C}$ $V_R = 0 \text{ V}$ $t = 10 \text{ ms}$ (50 Hz), sine $t = 8.3 \text{ ms}$ (60 Hz), sine	440 A ² s 455 A ² s
	$T_{VJ} = T_{VJM}$ $V_R = 0 \text{ V}$ $t = 10 \text{ ms}$ (50 Hz), sine $t = 8.3 \text{ ms}$ (60 Hz), sine	365 A ² s 370 A ² s
$(di/dt)_{cr}$	$T_{VJ} = 125^\circ\text{C}$ $f = 50 \text{ Hz}$, $t_p = 200 \mu\text{s}$ $V_D = 2/3 V_{DRM}$ $I_G = 0.3 \text{ A}$, $di_G/dt = 0.3 \text{ A}/\mu\text{s}$	repetitive, $I_T = 50 \text{ A}$ 500 A/ μs
	non repetitive, $I_T = 1/2 \cdot I_{dAV}$	500 A/ μs
$(dv/dt)_{cr}$	$T_{VJ} = T_{VJM}$; $V_{DR} = 2/3 V_{DRM}$ $R_{GK} = \infty$; method 1 (linear voltage rise)	1000 V/ μs
V_{RGM}		10 V
P_{GM}	$T_{VJ} = T_{VJM}$ $I_T = I_{TAVM}$ $t_p = 30 \mu\text{s}$ $t_p = 500 \mu\text{s}$ $t_p = 10 \text{ ms}$	$\leq 10 \text{ W}$ $\leq 5 \text{ W}$ $\leq 1 \text{ W}$
P_{GAVM}		0.5 W
T_{VJ}		-40...+125 °C
T_{VJM}		125 °C
T_{stg}		-40...+125 °C
V_{ISOL}	50/60 Hz, RMS $I_{ISOL} \leq 1 \text{ mA}$ $t = 1 \text{ min}$ $t = 1 \text{ s}$	3000 V~ 3600 V~
M_d	Mounting torque (M5) (10-32 UNF)	2-2.5 Nm 18-22 lb.in.
Weight		50 g

Features

- Package with DCB ceramic base plate
- Isolation voltage 3600 V~
- Planar passivated chips
- 1/4" fast-on terminals
- UL registered E 72873

Applications

- Supply for DC power equipment
- DC motor control

Advantages

- Easy to mount with two screws
- Space and weight savings
- Improved temperature and power cycling

Dimensions in mm (1 mm = 0.0394")

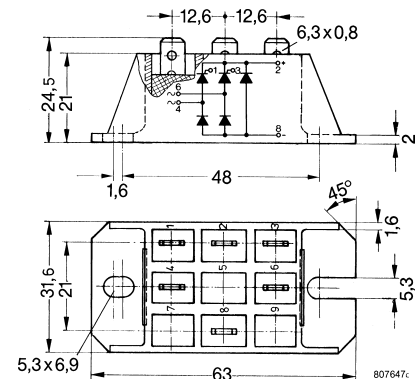

Data according to IEC 60747 and refer to a single thyristor/diode unless otherwise stated.

① for resistive load

IXYS reserves the right to change limits, test conditions and dimensions.

Symbol	Test Conditions	Characteristic Values
I_R, I_D	$V_R = V_{RRM}, V_D = V_{DRM}$ $T_{VJ} = T_{VJM}$ $T_{VJ} = 25^\circ\text{C}$	≤ 5 mA ≤ 0.3 mA
V_T, V_F	$I_T, I_F = 45$ A; $T_{VJ} = 25^\circ\text{C}$	≤ 1.6 V
V_{T0}	For power-loss calculations only ($T_{VJ} = 125^\circ\text{C}$)	0.9 V
r_T		15 m Ω
V_{GT}	$V_D = 6$ V; $T_{VJ} = 25^\circ\text{C}$ $T_{VJ} = -40^\circ\text{C}$	≤ 1.0 V ≤ 1.2 V
I_{GT}	$V_D = 6$ V; $T_{VJ} = 25^\circ\text{C}$ $T_{VJ} = -40^\circ\text{C}$ $T_{VJ} = 125^\circ\text{C}$	≤ 65 mA ≤ 80 mA ≤ 50 mA
V_{GD}	$T_{VJ} = T_{VJM}$; $V_D = 2/3 V_{DRM}$	≤ 0.2 V
I_{GD}	$T_{VJ} = T_{VJM}$; $V_D = 2/3 V_{DRM}$	≤ 5 mA
I_L	$I_G = 0.3$ A; $t_G = 30$ μs ; $T_{VJ} = 25^\circ\text{C}$ $di_G/dt = 0.3$ A/ μs ; $T_{VJ} = -40^\circ\text{C}$ $T_{VJ} = 125^\circ\text{C}$	≤ 150 mA ≤ 200 mA ≤ 100 mA
I_H	$T_{VJ} = 25^\circ\text{C}$; $V_D = 6$ V; $R_{CK} = \infty$	≤ 100 mA
t_{gd}	$T_{VJ} = 25^\circ\text{C}$; $V_D = 1/2 V_{DRM}$ $I_G = 0.3$ A; $di_G/dt = 0.3$ A/ μs	≤ 2 μs
t_q	$T_{VJ} = 125^\circ\text{C}$; $I_T = 15$ A; $t_p = 300$ μs ; $V_R = 100$ V	typ. 150 μs
Q_r	$di/dt = -10$ A/ μs ; $dv/dt = 20$ V/ μs ; $V_D = 2/3 V_{DRM}$	75 μC
R_{thJC}	per thyristor (diode); DC current	1.4 K/W
	per module	0.35 K/W
R_{thJK}	per thyristor (diode); DC current	2.0 K/W
	per module	0.5 K/W
d_s	Creepage distance on surface	12.6 mm
d_A	Creepage distance in air	6.3 mm
a	Max. allowable acceleration	50 m/s ²

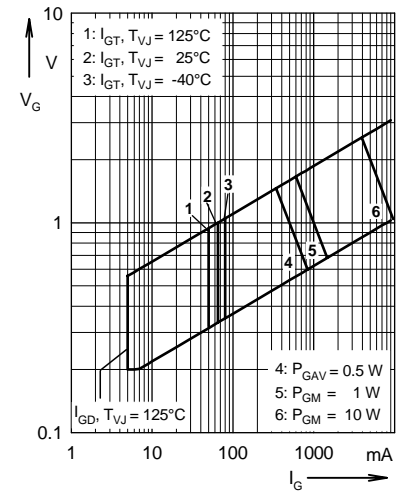

Fig. 1 Gate trigger range

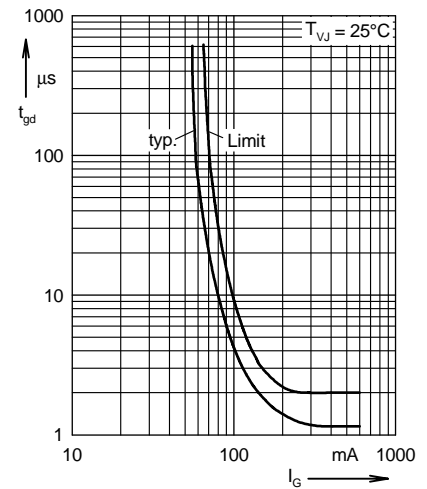

Fig. 2 Gate controlled delay time t_{gd}

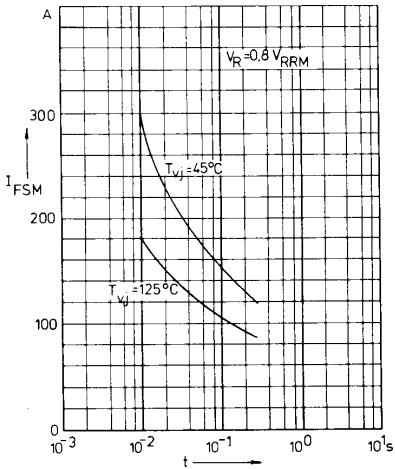

Fig. 3 Surge overload current per chip
 I_{FSM} : Crest value, t: duration

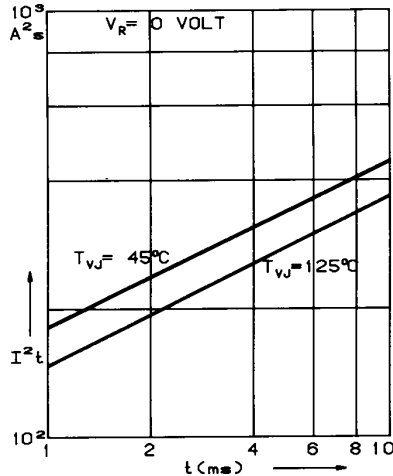

Fig. 4 I^2t versus time (1-10 ms) per chip

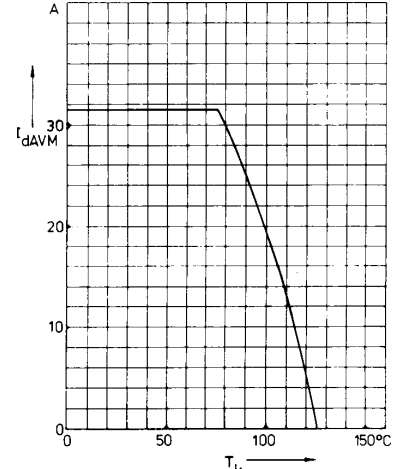

Fig. 5 Max. forward current at heatsink temperature

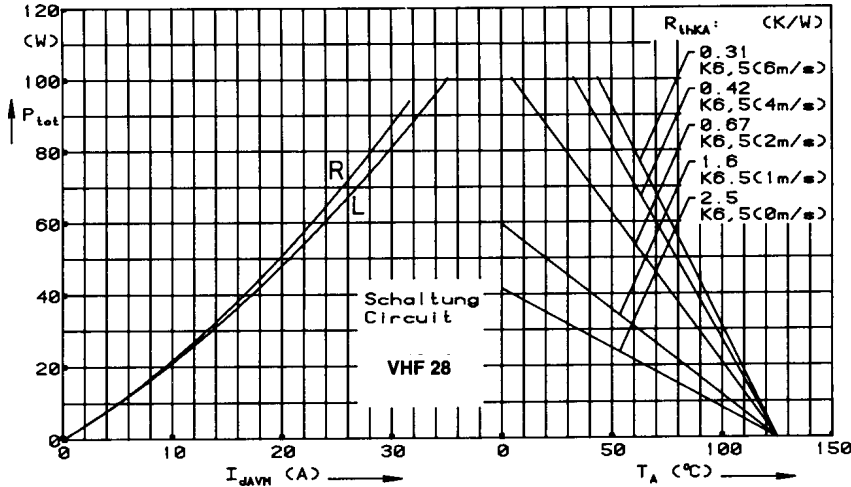

Fig. 6 Power dissipation versus direct output current and ambient temperature

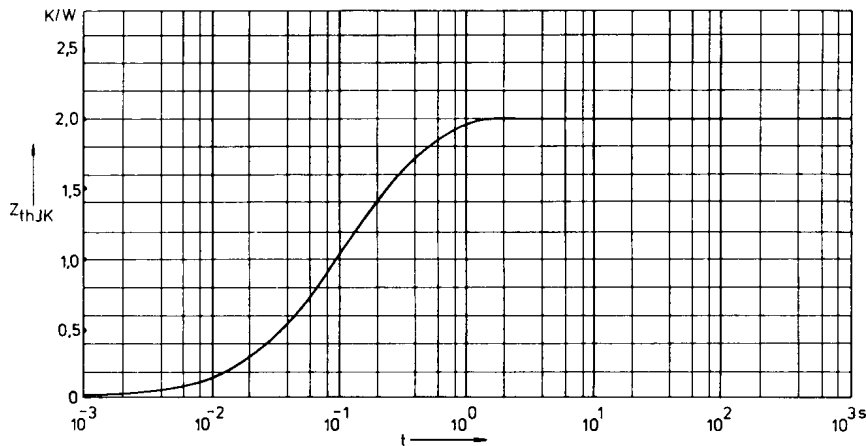

Fig. 7 Transient thermal impedance junction to heatsink per chip

Constants for Z_{thJK} calculation:

i	R_{thi} (K/W)	t_i (s)
1	0.3441	0.0344
2	1.1554	0.12
3	1.5005	0.5