

Intellimod™ L-Series Three Phase IGBT Inverter 300 Amperes/600 Volts

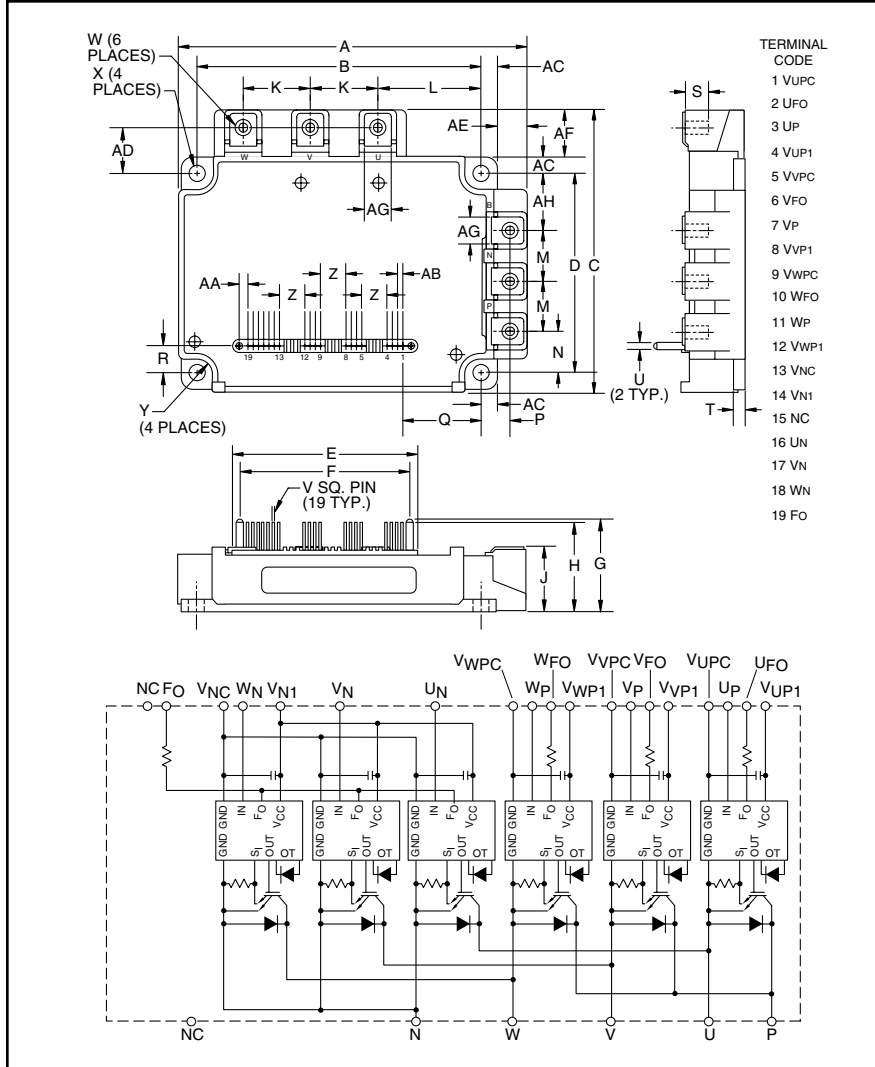

Outline Drawing and Circuit Diagram

Dimensions	Inches	Millimeters
A	5.31	135.0
B	4.33±0.02	110±0.5
C	4.33	110.0
D	3.07	78.0±0.5
E	2.81	71.5
F	2.62	66.5
G	1.37	34.7
H	1.32	33.6
J	0.95+0.04/-0.01	24.1+1.0/-0.5
K	1.02	26.0
L	1.59	40.5
M	0.79	20.0
N	0.65	16.5
P	0.43±0.01	11.0±0.3
Q	1.19	30.15
R	0.43	11.0

Dimensions	Inches	Millimeters
S	0.51	13.0
T	0.16	4.0
U	0.1 Dia.	Dia.2.5
V	0.02 Sq.	Sq. 0.5
W	M5 Metric	M5
X	0.22 Dia.	Dia. 5.5
Y	0.24 Rad.	Rad. 6
Z	0.39	10.0
AA	0.13	3.25
AB	0.08	2.0
AC	0.24	6.05
AD	0.71	18.0
AE	0.46	11.7
AF	0.74	18.7
AG	0.41	10.5
AH	0.85	21.5



Description:

Powerex Intellimod™ Intelligent Power Modules are isolated base modules designed for power switching applications operating at frequencies to 20kHz. Built-in control circuits provide optimum gate drive and protection for the IGBT and free-wheel diode power devices.

Features:

- Complete Output Power Circuit
- Gate Drive Circuit
- Protection Logic
 - Short Circuit
 - Over Temperature
 - Using On-chip Temperature Sensing
 - Under Voltage
- Low Loss Using 5th Generation IGBT Chip

Applications:

- Inverters
- UPS
- Motion/Servo Control
- Power Supplies

Ordering Information:

Example: Select the complete part number from the table below -i.e. PM300CLA060 is a 600V, 300 Ampere Intellimod™ Intelligent Power Module.

Type	Current Rating Amperes	V _{CEs} Volts (x 10)
PM	300	60

PM300CLA060
Intellimod™ L-Series
Three Phase IGBT Inverter
300 Amperes/600 Volts

Absolute Maximum Ratings, $T_j = 25^\circ\text{C}$ unless otherwise specified

Characteristics	Symbol	PM300CLA060	Units
Power Device Junction Temperature	T_j	-20 to 150	$^\circ\text{C}$
Storage Temperature	T_{stg}	-40 to 125	$^\circ\text{C}$
MMounting Torque, M5 Mounting Screws	—	31	in-lb
Mounting Torque, M5 Main Terminal Screws	—	31	in-lb
Module Weight (Typical)	—	800	Grams
Supply Voltage, Surge (Applied between P - N)	$V_{\text{CC(surge)}}$	550	Volts
Self-protection Supply Voltage Limit (Short Circuit protection Capability)*	$V_{\text{CC(prot.)}}$	400	Volts
Isolation Voltage, AC 1 minute, 60Hz Sinusoidal	V_{ISO}	2500	Volts

* $V_D = 13.5 - 16.5\text{V}$, Inverter Part, $T_j = 125^\circ\text{C}$

IGBT Inverter Sector

Collector-Emitter Voltage ($V_D = 15\text{V}$, $V_{\text{CIN}} = 15\text{V}$)	V_{CES}	600	Volts
Collector Current ($T_C = 25^\circ\text{C}$)	$\pm I_C$	300	Amperes
Peak Collector Current ($T_C = 25^\circ\text{C}$)	$\pm I_{\text{CP}}$	600	Amperes
Collector Dissipation ($T_C = 25^\circ\text{C}$)	P_C	801	Watts

Control Sector

Supply Voltage (Applied between $V_{\text{UP1}}-V_{\text{UPC}}$, $V_{\text{VP1}}-V_{\text{VPC}}$, $V_{\text{WP1}}-V_{\text{WPC}}$, $V_{\text{N1}}-V_{\text{NC}}$)	V_D	20	Volts
Input Voltage (Applied between U_P-V_{UPC} , V_P-V_{VPC} , W_P-V_{WPC} , U_N-V_N , W_N-V_{NC})	V_{CIN}	20	Volts
Fault Output Supply Voltage (Applied between $U_{\text{FO}}-V_{\text{UPC}}$, $V_{\text{FO}}-V_{\text{VPC}}$, $W_{\text{FO}}-V_{\text{WPC}}$, F_O-V_{NC})	V_{FO}	20	Volts
Fault Output Current (U_{FO} , V_{FO} , W_{FO} , F_O Terminals)	I_{FO}	20	mA

Note 1: T_C (Base Plate) Measurement Point

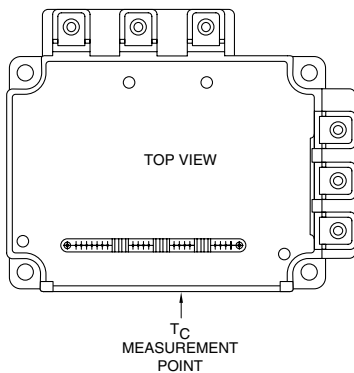

PM300CLA060
Intellimod™ L-Series
Three Phase IGBT Inverter
300 Amperes/600 Volts

Electrical and Mechanical Characteristics, $T_j = 25^\circ\text{C}$ unless otherwise specified

Characteristics	Symbol	Test Conditions	Min.	Typ.	Max.	Units
IGBT Inverter Sector						
Collector-Emitter Cutoff Current	I_{CES}	$V_{CE} = V_{CES}, V_D = 15V, T_j = 25^\circ\text{C}$	—	—	1.0	mA
		$V_{CE} = V_{CES}, V_D = 15V, T_j = 125^\circ\text{C}$	—	—	10	mA
Diode Forward Voltage	V_{EC}	$-I_C = 300A, V_{CIN} = 15V, V_D = 15V$	—	2.2	3.3	Volts
Collector-Emitter Saturation Voltage	$V_{CE(sat)}$	$V_D = 15V, V_{CIN} = 0V, I_C = 300A, T_j = 25^\circ\text{C}$	—	1.6	2.1	Volts
		$V_D = 15V, V_{CIN} = 0V, I_C = 300A, T_j = 125^\circ\text{C}$	—	1.5	2.0	Volts
Inductive Load Switching Times	t_{on}		0.5	1.0	2.4	μs
	t_{rr}	$V_D = 15V, V_{CIN} = 0 \Leftrightarrow 15V$	—	0.2	0.4	μs
	$t_{C(on)}$	$V_{CC} = 300V, I_C = 300A$	—	0.4	1.0	μs
	t_{off}	$T_j = 125^\circ\text{C}$	—	1.2	2.5	μs
	$t_{C(off)}$		—	0.5	1.0	μs
Control Sector						
Short Circuit Trip Level	SC	$-20^\circ\text{C} \leq T_j \leq 125^\circ\text{C}, V_D = 15V$	600	—	—	Amperes
Short Circuit Current Delay Time	$t_{off(SC)}$	$V_D = 15V$	—	0.2	—	μs
Over Temperature Protection	OT	Trip Level	135	145	155	$^\circ\text{C}$
(Detect T_j of IGBT Chip)	OT_R	Reset Level	—	125	—	$^\circ\text{C}$
Supply Circuit Under-voltage Protection	UV	Trip Level	11.5	12.0	12.5	Volts
($-20 \leq T_j \leq 125^\circ\text{C}$)	UV_R	Reset Level	—	12.5	—	Volts
Circuit Current	I_D	$V_D = 15V, V_{CIN} = 15V, V_{N1}-V_{NC}$	—	18	28	mA
		$V_D = 15V, V_{CIN} = 15V, V_{XP1}-V_{XPC}$	—	6	12	mA
Input ON Threshold Voltage	$V_{th(on)}$	Applied between U_P-V_{UPC} .	1.2	1.5	1.8	Volts
Input OFF Threshold Voltage	$V_{th(off)}$	$V_P-V_{VPC}, W_P-V_{WPC}, U_N-V_N, W_N-V_{NC}$	1.7	2.0	2.3	Volts
Fault Output Current*	$I_{FO(H)}$	$V_D = 15V, V_{CIN} = 15V$	—	—	0.01	mA
	$I_{FO(L)}$	$V_D = 15V, V_{CIN} = 15V$	—	10	15	mA
Fault Output Pulse Width*	t_{FO}	$V_D = 15V$	1.0	1.8	—	ms

*Fault output is given only when the internal SC, OT and UV protections schemes of either upper or lower device operate to protect it.

PM300CLA060
Intellimod™ L-Series
Three Phase IGBT Inverter
300 Amperes/600 Volts

Electrical and Mechanical Characteristics, $T_j = 25^\circ\text{C}$ unless otherwise specified

Characteristics	Symbol	Test Conditions	Min.	Typ.	Max.	Units
-----------------	--------	-----------------	------	------	------	-------

Thermal Characteristics

Characteristic	Symbol	Condition	Min.	Typ.	Max.	Units
Junction to Case Thermal Resistance	$R_{th(j-c)Q}$	IGBT (Per 1/6 Module) (Note 1)	—	—	0.16	$^\circ\text{C/Watt}$
	$R_{th(j-c)D}$	FWDi (Per 1/6 Module) (Note 1)	—	—	0.25	$^\circ\text{C/Watt}$
	$R_{th(j-c)Q}$	IGBT (Per 1/6 Module)	—	—	0.12	$^\circ\text{C/Watt}$
	$R_{th(j-c)D}$	FWDi (Per 1/6 Module)	—	—	0.19	$^\circ\text{C/Watt}$
Contact Thermal Resistance	$R_{th(c-f)}$	Case to Fin Per Module, Thermal Grease Applied	—	—	0.023	$^\circ\text{C/Watt}$

Recommended Conditions for Use

Characteristic	Symbol	Condition	Value	Units
Supply Voltage	V_{CC}	Applied across P-N Terminals	≤ 400	Volts
Control Supply Voltage*	V_D	Applied between $V_{UP1}-V_{UPC}$, $V_{VP1}-V_{VPC}$, $V_{WP1}-V_{WPC}$, $V_{N1}-V_{NC}$	15.0 ± 1.5	Volts
Input ON Voltage	$V_{CIN(on)}$	Applied between U_P-V_{UPC} ,	≤ 0.8	Volts
Input OFF Voltage	$V_{CIN(off)}$	V_P-V_{VPC} , W_P-V_{WPC} , U_N-V_N , W_N-V_{NC}	≥ 9.0	Volts
PWM Input Frequency	f_{PWM}	—	≤ 20	kHz
Arm Shoot-through Blocking Time	t_{DEAD}	Input Signal	≥ 2.0	μs

*With ripple satisfying the following conditions: dv/dt swing $\leq \pm 5\text{V}/\mu\text{s}$, Variation $\leq 2\text{V}$ peak to peak.

PM300CLA060
Intellimod™ L-Series
Three Phase IGBT Inverter
 300 Amperes/600 Volts

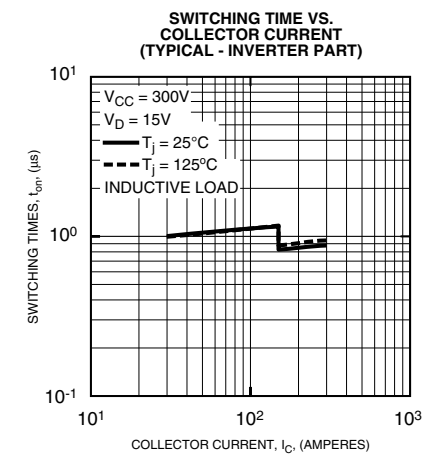
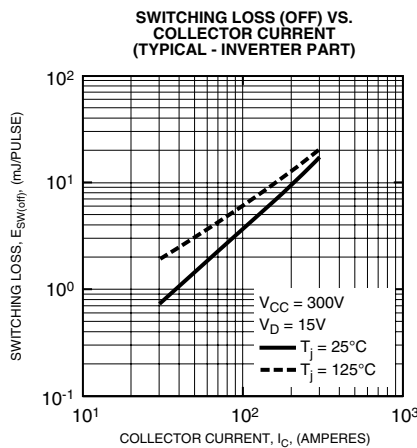
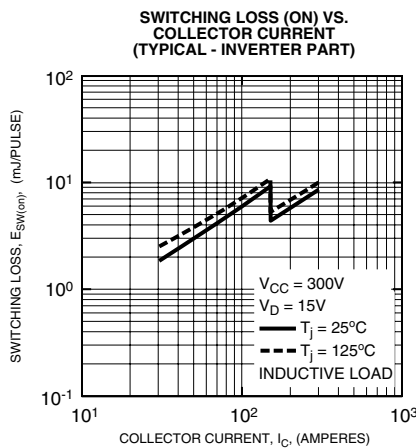
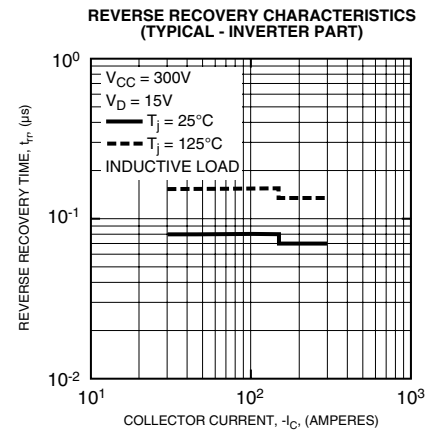
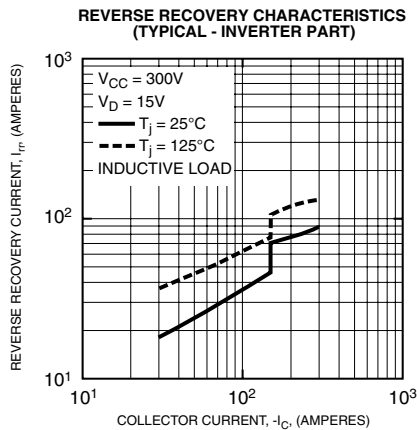
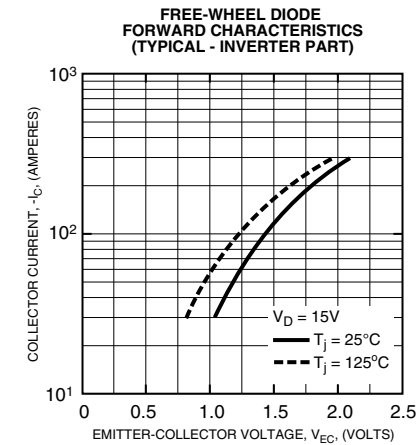
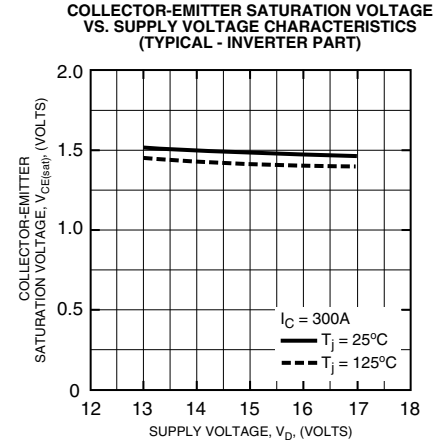
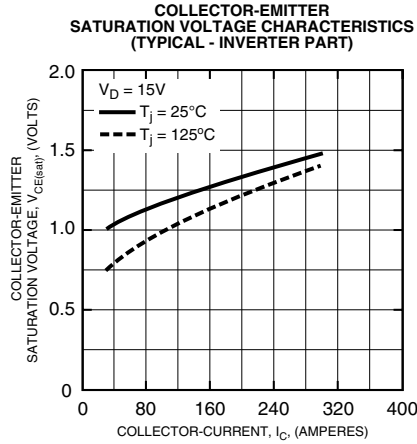
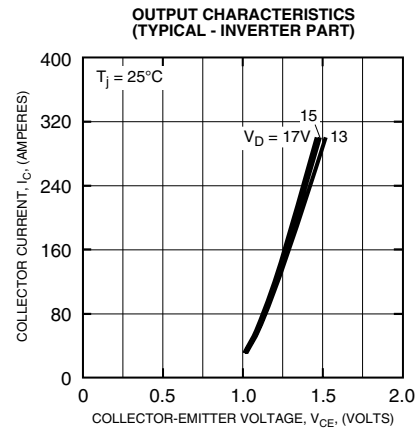

PM300CLA060
Intellimod™ L-Series
Three Phase IGBT Inverter
 300 Amperes/600 Volts

