

### Intellimod™ Module Half Phase IGBT Inverter Output 400 Amperes/1200 Volts

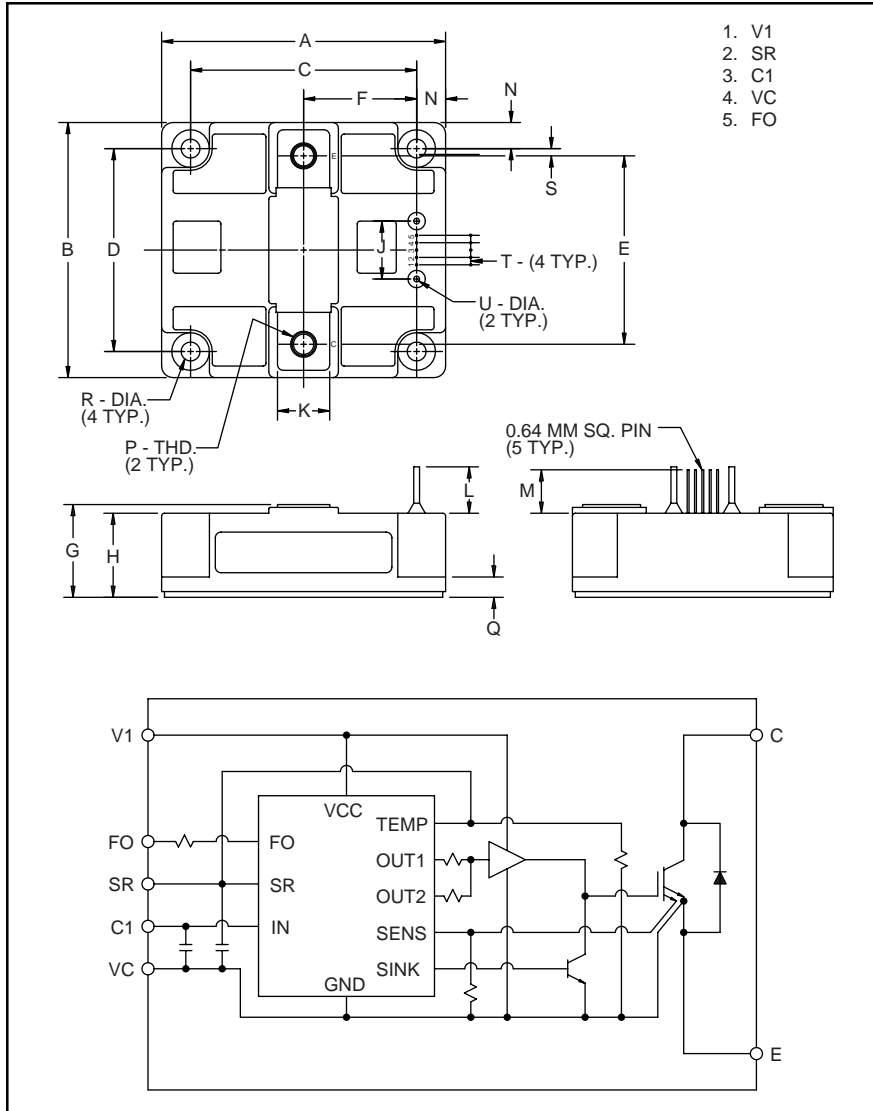

Outline Drawing and Circuit Diagram

Dimensions	Inches	Millimeters
A	3.86	98.0
B	3.46	88.0
C	3.15±0.01	80.0±0.25
D	2.76±0.01	70.0±0.25
E	2.56	65.0
F	1.57	40.0
G	1.34 +0.04/-0.02	34.0 +1.0/-0.5
H	1.16	29.5
J	0.79	20.0
K	0.71	18.0

Dimensions	Inches	Millimeters
L	0.63	16.0
M	0.59	15.0
N	0.35	9.0
P	Metric M8	M8
Q	0.28	7.0
R	0.26 Dia.	Dia. 6.5
S	0.10	2.5
T	0.100	2.54
U	0.08 Dia.	2.0 Dia.



#### Description:

Powerex Intellimod™ Intelligent Power Modules are isolated base modules designed for power switching applications operating at frequencies to 20kHz. Built-in control circuits provide optimum gate drive and protection for the IGBT and free-wheel diode power devices.

#### Features:

- Complete Output Power Circuit
- Gate Drive Circuit
- Protection Logic
  - Short Circuit
  - Over Current
  - Over Temperature
  - Under Voltage

#### Applications:

- Inverters
- UPS
- Motion/Servo Control
- Power Supplies

#### Ordering Information:

Example: Select the complete part number from the table below -i.e. PM400HSA120 is a 1200V, 400 Ampere Intellimod™ Intelligent Power Module.

Type	Current Rating Amperes	V <sub>CEs</sub> Volts (x 10)
PM	400	120

**PM400HSA120**  
**Intellimod™ Module**  
**Half Phase IGBT Inverter Output**  
 400 Amperes/1200 Volts

**Absolute Maximum Ratings,  $T_j = 25^\circ\text{C}$  unless otherwise specified**

Characteristics	Symbol	PM400HSA120	Units
Power Device Junction Temperature	$T_j$	-20 to 150	$^\circ\text{C}$
Storage Temperature	$T_{\text{stg}}$	-40 to 125	$^\circ\text{C}$
Case Operating Temperature	$T_C$	-20 to 100	$^\circ\text{C}$
Mounting Torque, M6 Mounting Screws	—	26	in-lb
Mounting Torque, M8 Main Terminal Screws	—	95	in-lb
Module Weight (Typical)	—	630	Grams
Supply Voltage Protected by OC and SC ( $V_D = 13.5 - 16.5\text{V}$ , Inverter Part)	$V_{\text{CC(prot.)}}$	800	Volts
Isolation Voltage, AC 1 minute, 60Hz Sinusoidal	$V_{\text{RMS}}$	2500	Volts

**Control Sector**

Supply Voltage Applied between ( $V_1-V_C$ )	$V_D$	20	Volts
Input Voltage Applied between ( $C_1-V_C$ )	$V_{\text{CIN}}$	10	Volts
Fault Output Supply Voltage (Applied between $F_O-V_C$ )	$V_{\text{FO}}$	20	Volts
Fault Output Current	$I_{\text{FO}}$	20	mA

**IGBT Inverter Sector**

Collector-Emitter Voltage ( $V_D = 15\text{V}$ , $V_{\text{CIN}} = 5\text{V}$ )	$V_{\text{CES}}$	1200	Volts
Collector Current, $\pm$	$I_C$	400	Amperes
Peak Collector Current, $\pm$	$I_{\text{CP}}$	1200	Amperes
Collector Dissipation	$P_C$	2318	Watts

**Electrical and Mechanical Characteristics,  $T_j = 25^\circ\text{C}$  unless otherwise specified**

Characteristics	Symbol	Test Conditions	Min.	Typ.	Max.	Units
<b>Control Sector</b>						
Over Current Trip Level Inverter Part	OC	$-20^\circ\text{C} \leq T_j \leq 125^\circ\text{C}$	500	650	--	Amperes
Short Circuit Trip Level Inverter Part	SC	$-20^\circ\text{C} \leq T_j \leq 125^\circ\text{C}$	650	910	—	Amperes
Over Current Delay Time	$t_{\text{off(OC)}}$	$V_D = 15\text{V}$	—	5	—	$\mu\text{S}$
Over Temperature Protection	OT	Trip Level	100	110	120	$^\circ\text{C}$
	$OT_R$	Reset Level	85	95	105	$^\circ\text{C}$
Supply Circuit Under Voltage Protection	UV	Trip Level	11.5	12.0	12.5	Volts
	$UV_R$	Reset Level	—	12.5	—	Volts
Supply Voltage	$V_D$	Applied between $V_1-V_C$	13.5	15	16.5	Volts
Circuit Current	$I_D$	$V_D = 15\text{V}$ , $V_{\text{CIN}} = 5\text{V}$ , $V_1-V_C$	—	23	30	mA
Input ON Threshold Voltage	$V_{\text{CIN(on)}}$	Applied between $C_1-V_C$	1.2	1.5	1.8	Volts
Input OFF Threshold Voltage	$V_{\text{CIN(off)}}$	Applied between $C_1-V_C$	1.7	2.0	2.3	Volts
PWM Input Frequency	$f_{\text{PWM}}$	3- $\emptyset$ Sinusoidal	—	15	20	kHz
Fault Output Current	$I_{\text{FO(H)}}$	$V_D = 15\text{V}$ , $V_{\text{FO}} = 15\text{V}$	—	—	0.01	mA
	$I_{\text{FO(L)}}$	$V_D = 15\text{V}$ , $V_{\text{FO}} = 15\text{V}$	—	10	15	mA
Minimum Fault Output Pulse Width	$t_{\text{FO}}$	$V_D = 15\text{V}$	1.0	1.8	—	mS
SXR Terminal Output Voltage	$V_{\text{SXR}}$	$T_j \leq 125^\circ\text{C}$ , $R_{\text{in}} = 6.8 \text{ k}\Omega$	4.5	5.1	5.6	Volts

**PM400HSA120**  
**Intellimod™ Module**  
**Half Phase IGBT Inverter Output**  
**400 Amperes/1200 Volts**

**Electrical and Mechanical Characteristics,  $T_j = 25^\circ\text{C}$  unless otherwise specified**

Characteristics	Symbol	Test Conditions	Min.	Typ.	Max.	Units
<b>IGBT Inverter Sector</b>						
Collector Cutoff Current	$I_{CEX}$	$V_{CE} = V_{CES}, T_j = 25^\circ\text{C}$	—	—	1.0	mA
		$V_{CE} = V_{CES}, T_j = 125^\circ\text{C}$	—	—	10	mA
Diode Forward Voltage	$V_{FM}$	$-I_C = 400\text{A}, V_D = 15\text{V}, V_{CIN} = 5\text{V}$	—	2.5	3.5	Volts
Collector-Emitter Saturation Voltage	$V_{CE(sat)}$	$V_D = 15\text{V}, V_{CIN} = 0\text{V}, I_C = 400\text{A}, T_j = 25^\circ\text{C}, \text{Pulsed}$	—	2.3	3.0	Volts
		$V_D = 15\text{V}, V_{CIN} = 0\text{V}, I_C = 400\text{A}, T_j = 125^\circ\text{C}, \text{Pulsed}$	—	2.1	2.9	Volts
Inductive Load Switching Times	$t_{on}$	$V_D = 15\text{V}, V_{CIN} = 0 \sim 5\text{V}$ $V_{CC} = 600\text{V}, I_C = 400\text{A}$ $T_j = 125^\circ\text{C}$	0.5	1.4	2.5	$\mu\text{S}$
	$t_{rr}$		—	0.2	0.4	$\mu\text{S}$
	$t_{C(on)}$		—	0.4	1.0	$\mu\text{S}$
	$t_{off}$		—	3.0	4.0	$\mu\text{S}$
	$t_{C(off)}$		—	0.6	1.1	$\mu\text{S}$

**Thermal Characteristics**

Characteristic	Symbol	Condition	Min.	Typ.	Max.	Units
Junction to Case Thermal Resistance	$R_{th(j-c)Q}$	Each IGBT	—	—	0.054	$^\circ\text{C/Watt}$
	$R_{th(j-c)D}$	Each FWDi	—	—	0.10	$^\circ\text{C/Watt}$
Contact Thermal Resistance	$R_{th(c-f)}$	Case to Fin Per Module, Thermal Grease Applied	—	—	0.038	$^\circ\text{C/Watt}$

**Recommended Conditions for Use**

Characteristic	Symbol	Condition	Value	Units
Supply Voltage	$V_{CC}$	Applied across C1-E2 Terminals	0 ~ 800	Volts
	$V_D$	Applied between $V_1-V_C$	$15 \pm 1.5$	Volts
Input ON Voltage	$V_{CIN(on)}$	Applied between $C_1-V_C$	0 ~ 0.8	Volts
Input OFF Voltage	$V_{CIN(off)}$	Applied between $C_1-V_C$	$4.0 \sim V_{SXR}$	Volts
PWM Input Frequency	$f_{PWM}$	Using Application Circuit	5 ~ 20	kHz
Minimum Dead Time	$t_{DEAD}$	Input Signal	$\geq 4.0$	$\mu\text{S}$

**PM400HSA120**  
**Intellimod™ Module**  
**Half Phase IGBT Inverter Output**  
 400 Amperes/1200 Volts

**SATURATION VOLTAGE CHARACTERISTICS (TYPICAL)**

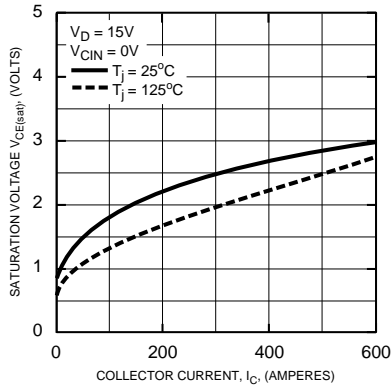

**COLLECTOR-EMITTER SATURATION VOLTAGE CHARACTERISTICS (TYPICAL)**

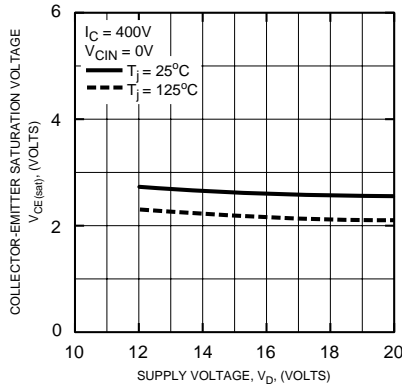

**OUTPUT CHARACTERISTICS (TYPICAL)**

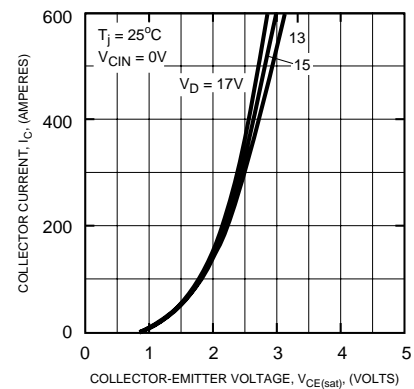

**SWITCHING TIME VS. COLLECTOR CURRENT (TYPICAL)**

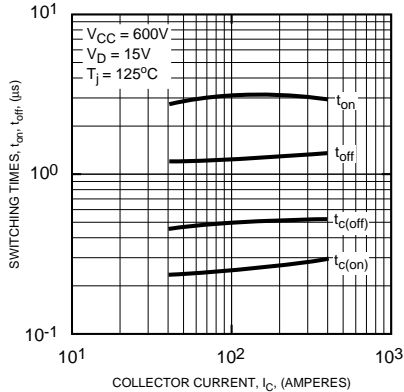

**REVERSE RECOVERY CURRENT VS. COLLECTOR CURRENT (TYPICAL)**

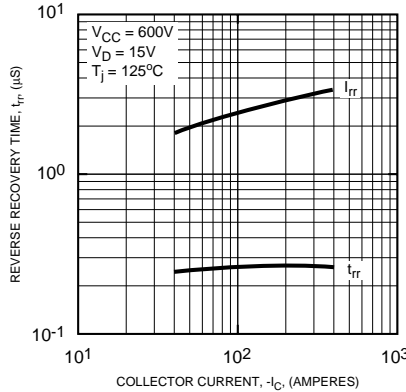

**DIODE FORWARD CHARACTERISTICS**

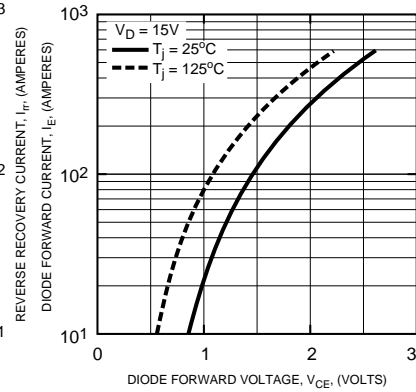

**TRANSIENT THERMAL IMPEDANCE CHARACTERISTICS (IGBT)**

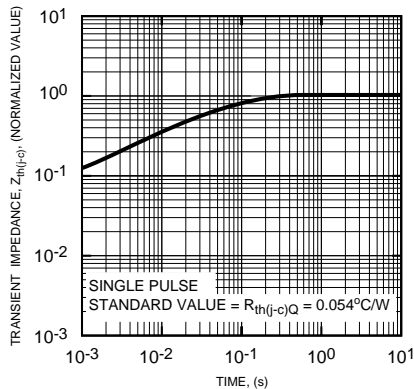

**TRANSIENT THERMAL IMPEDANCE CHARACTERISTICS (FWDI)**

