

#### Description:

DIP-IPMs are intelligent power modules that integrate power devices, drivers, and protection circuitry in an ultra compact dual-in-line transfer-mold package for use in driving small three phase motors. Use of 5th generation CSTBT Chip Technology, DIP packaging, and application specific HVICs allow the designer to reduce inverter size and overall design time.

#### Features:

- Compact Packages
- Single Power Supply
- Integrated HVICs
- Direct Connection to CPU

#### Applications:

- Washing Machines
- Refrigerators
- Air Conditioners
- Small Servo Motors
- Small Motor Control

#### Ordering Information:

PS21265-P (short pin) /  
PS21265-AP (long pin) are 600V,  
20 Ampere DIP Intelligent Power  
Modules.

#### Outline Drawing and Circuit Diagram

Dimensions	Inches	Millimeters
A	2.98	75.6
B	1.22±0.02	31.0±0.5
C	0.45±0.02	11.5±0.5
D	3.11±0.02	79.0±0.5
E	2.64±0.015	67.0±0.3
F	0.79±0.01	20.0±0.3
G	0.4±0.015	10.0±0.3
H	0.11±0.015	2.8±0.3
J	0.18±0.01 Dia.	4.5±0.2 Dia.
K	1.37±0.02	34.9±0.5
L	0.53±0.02	13.4±0.5
M	0.84±0.02	21.4±0.5
N	1.10±0.02	28.0±0.5
P	0.45	11.5
Q	0.33	8.5
R	0.15±0.01	3.8±0.2

Dimensions	Inches	Millimeters
S	2.80	71.0
T	0.62±0.02	16.0±0.5
U	0.49±0.02	12.8±0.5
V	0.31±0.02	8.0±0.5
W	0.02±0.01	0.5±0.2
X	0 ~ 5°	0 ~ 5°
Y	0.04±0.01	1.0±0.2
Z	0.03	0.7
AA	0.03±0.01	0.7±0.2
AB	0.04	1.0
AC	0.1	2.5
AD	0.02 Max.	0.5 Max.
AE	0.024±0.2	0.6±0.5
AF	0.03±0.01	0.8±0.02
AG	0.024	0.6
AH	0.02±0.01	0.45±0.02

**PS21265-P / PS21265-AP**  
**Intellimod™ Module**  
**Dual-In-Line Intelligent Power Module**  
 20 Amperes/600 Volts

**Absolute Maximum Ratings,  $T_j = 25^\circ\text{C}$  unless otherwise specified**

Characteristics	Symbol	PS21265-P / PS21265-AP	Units
Power Device Junction Temperature*	$T_j$	-20 to 125	$^\circ\text{C}$
Module Case Operation Temperature (See $T_C$ Measurement Point Illustration)	$T_C$	-20 to 100	$^\circ\text{C}$
Storage Temperature	$T_{stg}$	-40 to 125	$^\circ\text{C}$
Mounting Torque, M4 Mounting Screws	—	13	in-lb
Module Weight (Typical)	—	54	Grams
Self-protection Supply Voltage Limit (Short Circuit Protection Capability)**	$V_{CC(prot.)}$	400	Volts
Isolation Voltage, AC 1 minute, 60Hz Sinusoidal, Connection Pins to Heatsink Plate	$V_{ISO}$	2500	Volts

\*The maximum junction temperature rating of the power chips integrated within the DIP-IPM is  $150^\circ\text{C}$  ( $@T_C \leq 100^\circ\text{C}$ ). However, to ensure safe operation of the DIP-IPM, the average junction temperature should be limited to  $T_{j(avg)} \leq 125^\circ\text{C}$  ( $@T_C \leq 100^\circ\text{C}$ ).

\*\* $V_D = 13.5 \sim 16.5\text{V}$ , Inverter Part,  $T_j = 125^\circ\text{C}$ , Non-repetitive, Less than  $2\mu\text{s}$

**IGBT Inverter Sector**

Collector-Emitter Voltage ( $T_C = 25^\circ\text{C}$ )	$V_{CES}$	600	Volts
Collector Current ( $T_C = 25^\circ\text{C}$ )	$\pm I_C$	20	Amperes
Peak Collector Current ( $T_C = 25^\circ\text{C}$ , $<1\text{ms}$ )	$\pm I_{CP}$	40	Amperes
Supply Voltage (Applied between P - N)	$V_{CC}$	450	Volts
Supply Voltage, Surge (Applied between P - N)	$V_{CC(surge)}$	500	Volts
Collector Dissipation ( $T_C = 25^\circ\text{C}$ , per 1 Chip)	$P_C$	51.2	Watts

**Control Sector**

Supply Voltage (Applied between $V_{P+}$ - $V_{PC}$ , $V_{N+}$ - $V_{NC}$ )	$V_D$	20	Volts
Supply Voltage (Applied between $V_{UFB}$ - $V_{UFS}$ , $V_{VFB}$ - $V_{VFS}$ , $V_{WFB}$ - $V_{WFS}$ )	$V_{DB}$	20	Volts
Input Voltage (Applied between $U_P$ , $V_P$ , $W_P$ - $V_{PC}$ , $U_N$ , $V_N$ , $W_N$ - $V_{NC}$ )	$V_{IN}$	-0.5 ~ $V_D+0.5$	Volts
Fault Output Supply Voltage (Applied between $F_O$ - $V_{NC}$ )	$V_{FO}$	-0.5 ~ $V_D+0.5$	Volts
Fault Output Current (Sink Current at $F_O$ Terminal)	$I_{FO}$	1	mA
Current Sensing Input Voltage (Applied between $C_{IN}$ - $V_{NC}$ )	$V_{SC}$	-0.5 ~ $V_D+0.5$	Volts

PS21265-P / PS21265-AP  
 Intellimod™ Module  
 Dual-In-Line Intelligent Power Module  
 20 Amperes/600 Volts

## Electrical and Mechanical Characteristics, $T_j = 25^\circ\text{C}$ unless otherwise specified

Characteristics	Symbol	Test Conditions	Min.	Typ.	Max.	Units
<b>IGBT Inverter Sector</b>						
Collector-Emitter Cutoff Current	$I_{CES}$	$V_{CE} = V_{CES}, T_j = 25^\circ\text{C}$	—	—	1.0	mA
		$V_{CE} = V_{CES}, T_j = 125^\circ\text{C}$	—	—	10	mA
Diode Forward Voltage	$V_{EC}$	$T_j = 25^\circ\text{C}, -I_C = 20\text{A}, V_{IN} = 0\text{V}$	—	1.5	2.0	Volts
Collector-Emitter Saturation Voltage	$V_{CE(sat)}$	$I_C = 20\text{A}, T_j = 25^\circ\text{C}, V_D = V_{DB} = 15\text{V}, V_{IN} = 5\text{V}$	—	1.55	2.05	Volts
		$I_C = 20\text{A}, T_j = 125^\circ\text{C}, V_D = V_{DB} = 15\text{V}, V_{IN} = 5\text{V}$	—	1.65	2.15	Volts
Inductive Load Switching Times	$t_{on}$		0.65	1.25	1.85	$\mu\text{s}$
	$t_{rr}$	$V_{CC} = 300\text{V}, V_D = V_{DB} = 15\text{V},$	—	0.30	—	$\mu\text{s}$
	$t_{C(on)}$	$I_C = 20\text{A}, T_j = 125^\circ\text{C}, V_{IN} = 5 \leftrightarrow 0\text{V},$	—	0.40	0.60	$\mu\text{s}$
	$t_{off}$	Inductive Load (Upper-Lower Arm)	—	1.50	2.10	$\mu\text{s}$
	$t_{C(off)}$		—	0.50	0.80	$\mu\text{s}$

$T_C$  Measurement Point

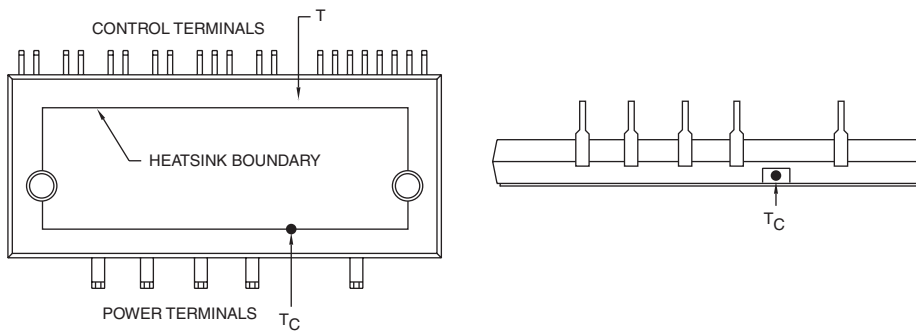

PS21265-P / PS21265-AP  
 Intellimod™ Module  
 Dual-In-Line Intelligent Power Module  
 20 Amperes/600 Volts

## Electrical and Mechanical Characteristics, $T_j = 25^\circ\text{C}$ unless otherwise specified

Characteristics	Symbol	Test Conditions	Min.	Typ.	Max.	Units
<b>Control Sector</b>						
Circuit Current	$I_D$	$V_D = V_{DB} = 15\text{V}, V_{IN} = 5\text{V},$ Total of $V_{P1}-V_{PC}, V_{N1}-V_{NC}$	—	—	7.00	mA
		$V_D = V_{DB} = 15\text{V}, V_{IN} = 0\text{V},$ Total of $V_{P1}-V_{PC}, V_{N1}-V_{NC}$	—	—	7.00	mA
		$V_D = V_{DB} = 15\text{V}, V_{IN} = 5\text{V},$ $V_{UFB}-V_{UFS}, V_{VFB}-V_{VFS}, V_{WFB}-V_{WFS}$	—	—	0.55	mA
		$V_D = V_{DB} = 15\text{V}, V_{IN} = 0\text{V},$ $V_{UFB}-V_{UFS}, V_{VFB}-V_{VFS}, V_{WFB}-V_{WFS}$	—	—	0.55	mA
Fault Output Voltage	$V_{FOH}$	$V_{SC} = 0\text{V}, F_O$ Circuit: 10k $\Omega$ to 5V Pull-up	4.9	—	—	Volts
	$V_{FOL}$	$V_{SC} = 1\text{V}, I_{FO} = 1\text{mA}$	—	—	0.95	Volts
Input Current	$I_{IN}$	$V_{IN} = 5\text{V}$	1.0	1.5	2.00	mA
Short-Circuit Trip Level*	$V_{SC(\text{ref})}$	$T_C = 20 \sim 100^\circ\text{C}, V_D = 15\text{V}$	0.45	—	0.52	Volts
Supply Circuit Undervoltage Protection	$UV_{DBt}$	Trip Level, $T_j \leq 125^\circ\text{C}$	10.0	—	12.0	Volts
	$UV_{DBr}$	Reset Level, $T_j \leq 125^\circ\text{C}$	10.5	—	12.5	Volts
	$UV_{Dt}$	Trip Level, $T_j \leq 125^\circ\text{C}$	10.3	—	12.5	Volts
	$UV_{Dr}$	Reset Level, $T_j \leq 125^\circ\text{C}$	10.8	—	13.0	Volts
Fault Output Pulse Width**	$t_{FO}$	$C_{FO} = 22\text{nF}$	1.0	1.8	—	ms
ON Threshold Voltage	$V_{th(\text{on})}$	Applied between $U_P, V_P, W_P-V_{PC},$	2.1	2.3	2.6	Volts
OFF Threshold Voltage	$V_{th(\text{off})}$	$U_N, V_N, W_N-V_{NC}$	0.8	1.4	2.1	Volts

## Thermal Characteristics

Characteristic	Symbol	Condition	Min.	Typ.	Max.	Units
Junction to Fin	$R_{th(j-f)Q}$	IGBT Part (Per 1/6 Module)	—	—	1.95	$^\circ\text{C/W}$
Thermal Resistance	$R_{th(j-f)D}$	FWDi Part (Per 1/6 Module)	—	—	3.00	$^\circ\text{C/W}$
Contact Thermal Resistance	$R_{th(c-f)}$	Case to Fin (Per 1 Module)	—	—	0.067	$^\circ\text{C/W}$

\* Short-Circuit protection is functioning only at the lower arms. Please select the value of the external shunt resistor such that the SC trip level is less than 30A.

\*\* Fault signal is asserted when the lower arm short circuit or control supply under-voltage protective functions operate. The fault output pulse-width  $t_{FO}$  depends on the capacitance value of  $C_{FO}$  according to the following approximate equation:  $C_{FO} = (12.2 \times 10^{-6}) \times t_{FO} (F)$ .

PS21265-P / PS21265-AP  
 Intellimod™ Module  
 Dual-In-Line Intelligent Power Module  
 20 Amperes/600 Volts

## Recommended Conditions for Use

Characteristic	Symbol	Condition	Min.	Typ.	Max.	Units	
Supply Voltage	$V_{CC}$	Applied between P-N	0	300	400	Volts	
Control Supply Voltage	$V_D$	Applied between $V_{P1}$ - $V_{PC}$ , $V_{N1}$ - $V_{NC}$	13.5	15.0	16.5	Volts	
	$V_{DB}$	Applied between $V_{UFB}$ - $V_{UFS}$ , $V_{VFB}$ - $V_{VFS}$ , $V_{WFB}$ - $V_{WFS}$	13.0	15.0	18.5	Volts	
Control Supply Variation	$\Delta V_D$ , $\Delta V_{DB}$	—	-1	—	1	Volts/ $\mu$ s	
PWM Input Frequency	$f_{PWM}$	$T_C \leq 100^\circ\text{C}$ , $T_J \leq 125^\circ\text{C}$	—	—	20	kHz	
Allowable rms Current*	$I_O$	$V_{CC} = 300\text{V}$ , $V_D = V_{DB} = 15\text{V}$ , $f_{PWM} = 5\text{kHz}$ , PF = 0.8, Sinusoidal, $T_J \leq 125^\circ\text{C}$ , $T_C \leq 100^\circ\text{C}$	—	—	14.0	Arms	
		$V_{CC} = 300\text{V}$ , $V_D = V_{DB} = 15\text{V}$ , $f_{PWM} = 15\text{kHz}$ , PF = 0.8, Sinusoidal, $T_J \leq 125^\circ\text{C}$ , $T_f \leq 100^\circ\text{C}$	—	—	9.5	Arms	
Minimum Input	$P_{WIN(on)}$ **	—	0.3	—	—	$\mu$ s	
Pulse Width	$P_{WIN(off)}$ ***	Below Rated Current	$200 \leq V_{CC} \leq 350\text{V}$ ,	1.4	—	—	$\mu$ s
		Between Rated Current & 1.7 Times of Rated Current	$13.5 \leq V_D \leq 16.5\text{V}$ ,	2.5	—	—	$\mu$ s
		Between 1.7 Times of Rated & 2.0 Times of Rated Current	$13.0 \leq V_{DB} \leq 18.5\text{V}$ ,	—	—	—	$\mu$ s
			$-20^\circ\text{C} \leq T_C \leq 100^\circ\text{C}$ ,	3.0	—	—	$\mu$ s
			N-line Wiring Inductance Less Than 10nH	—	—	—	$\mu$ s
$V_{NC}$ Variation	$V_{NC}$	Between $V_{NC-N}$ (Including Surge)	-5.0	—	5.0	Volts	
Arm Shoot-through	$t_{DEAD}$	For Each Input Signal, $T_C < 100^\circ\text{C}$	2	—	—	$\mu$ s	
Blocking Time							

\* The allowable rms current value depends on the actual application conditions.

\*\*If input signal ON pulse is less than  $P_{WIN(on)}$ , the device may not respond.

\*\*\*The IPM may fail to respond to an ON pulse if the preceding OFF pulse is less than  $P_{WIN(off)}$ .

**PS21265-P / PS21265-AP**  
**Intellimod™ Module**  
**Dual-In-Line Intelligent Power Module**  
**20 Amperes/600 Volts**

**COLLECTOR-EMITTER SATURATION VOLTAGE CHARACTERISTICS (TYPICAL)**

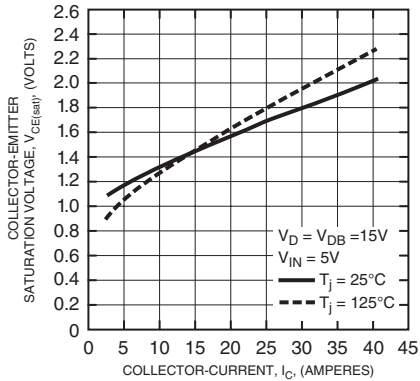

**FREE-WHEEL DIODE FORWARD CHARACTERISTICS (TYPICAL)**

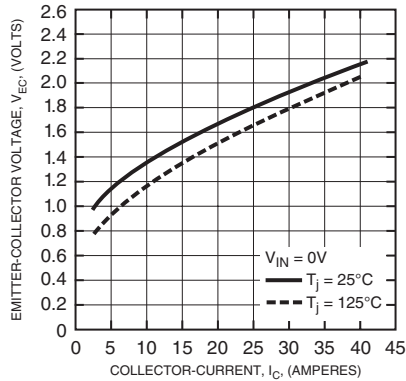

**REVERSE RECOVERY CHARACTERISTICS (TYPICAL - N-SIDE)**

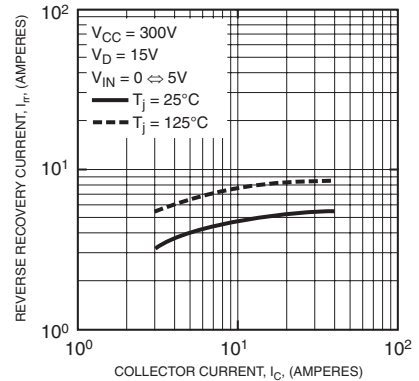

**REVERSE RECOVERY CHARACTERISTICS (TYPICAL - N-SIDE)**

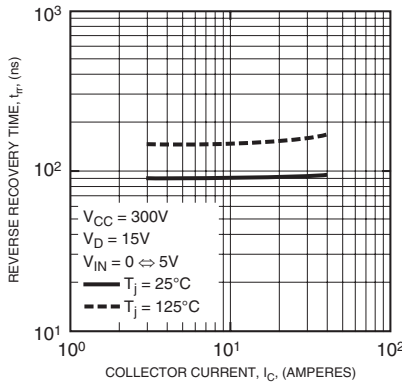

**REVERSE RECOVERY CHARACTERISTICS (TYPICAL - P-SIDE)**

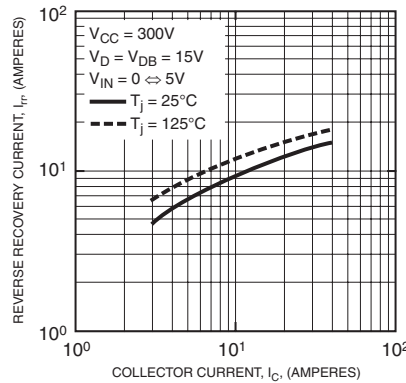

**REVERSE RECOVERY CHARACTERISTICS (TYPICAL - P-SIDE)**

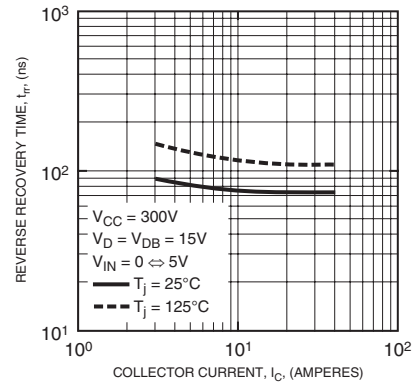

**SWITCHING LOSS (ON) VS. COLLECTOR CURRENT (TYPICAL - N-SIDE)**

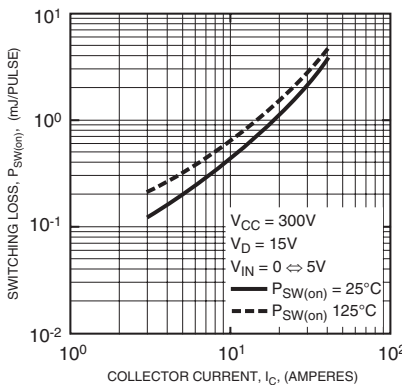

**SWITCHING LOSS (OFF) VS. COLLECTOR CURRENT (TYPICAL - N-SIDE)**

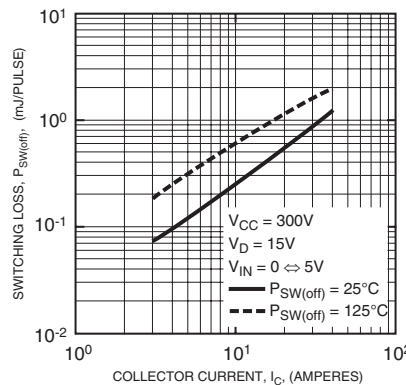

**SWITCHING LOSS (ON) VS. COLLECTOR CURRENT (TYPICAL - P-SIDE)**

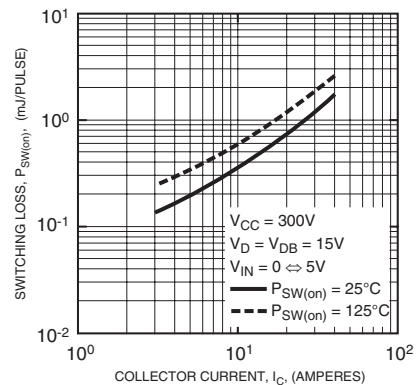

**PS21265-P / PS21265-AP**  
**Intellimod™ Module**  
**Dual-In-Line Intelligent Power Module**  
**20 Amperes/600 Volts**

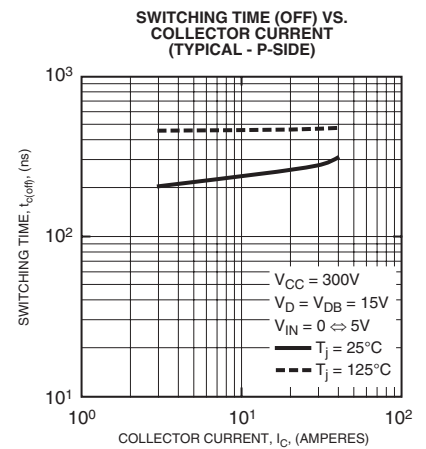
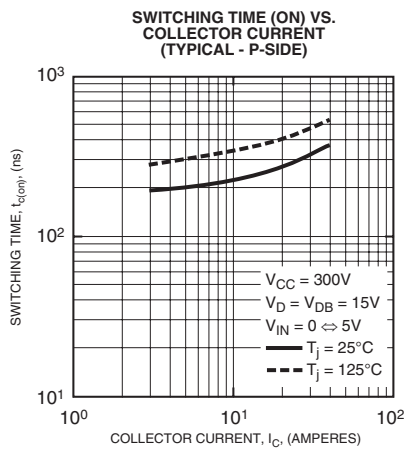
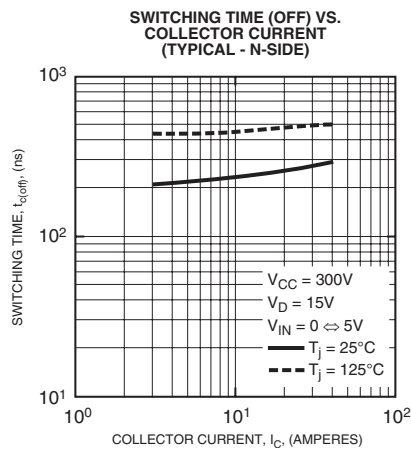
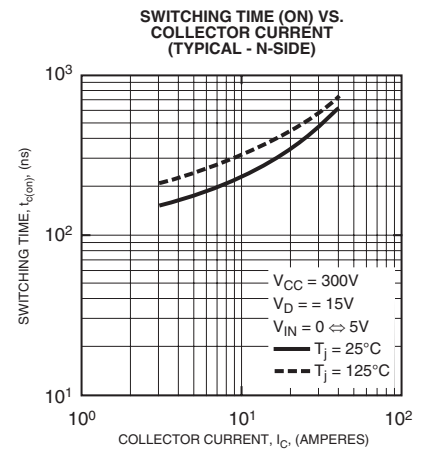
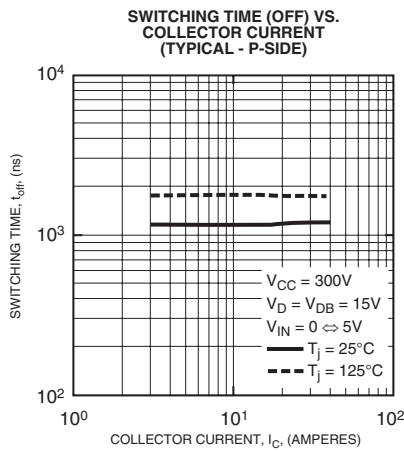
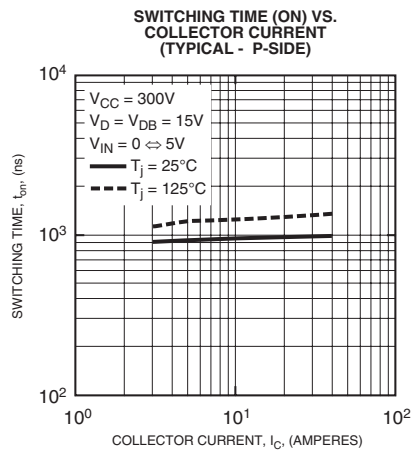
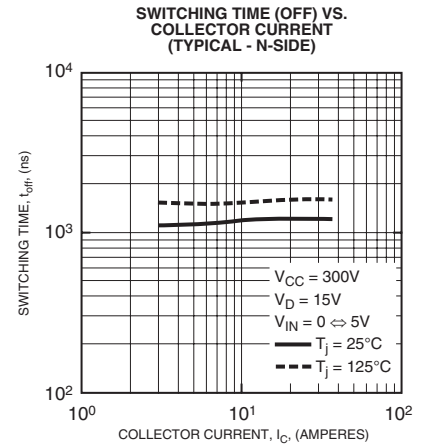
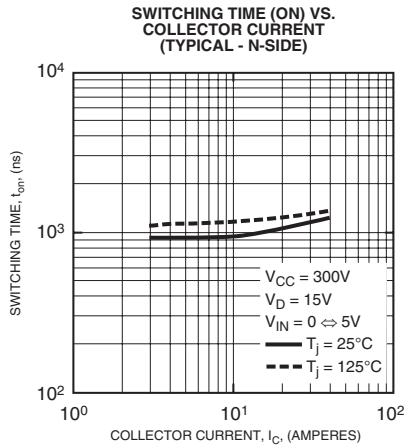
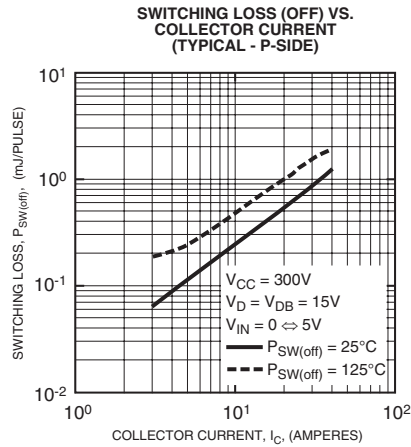

**PS21265-P / PS21265-AP**  
**Intellimod™ Module**  
**Dual-In-Line Intelligent Power Module**  
 20 Amperes/600 Volts

**DIP-IPM Application Circuit (Shown Pins Up)**

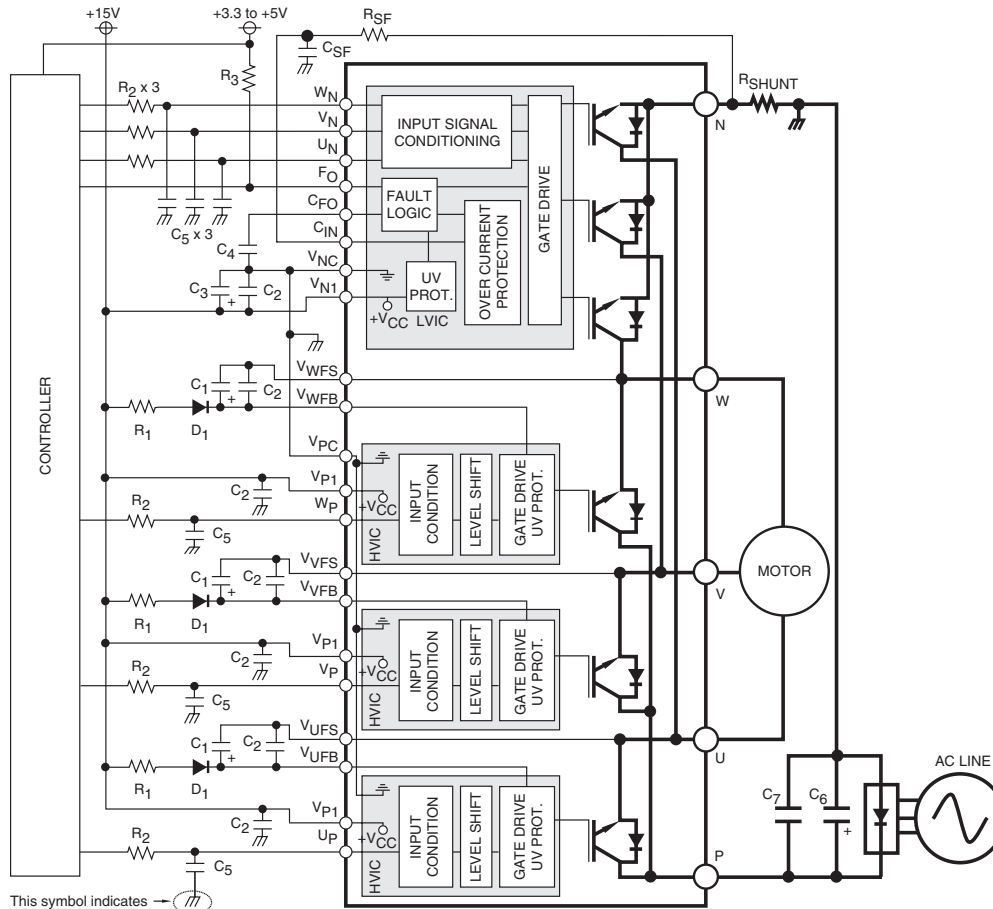

This symbol indicates connection to ground plane.

**Component Selection:**

Dsgn.	Typ. Value	Description
D1	1A, 600V	Boot strap supply diode – Ultra fast recovery
C1	10-100uF, 50V	Boot strap supply reservoir – Electrolytic, long life, low Impedance, 105°C (Note 5)
C2	0.22-2.0uF, 50V	Local decoupling/High frequency noise filters – Multilayer ceramic (Note 8)
C3	10-100uF, 50V	Control power supply filter – Electrolytic, long life, low Impedance, 105°C
C4	22nF, 50V	Fault lock-out timing capacitor – Multilayer ceramic (Note 4)
C5	100pF, 50V	Optional input signal noise filter – Multilayer ceramic (Note 1)
C6	200-2000uF, 450V	Main DC bus filter capacitor – Electrolytic, long life, high ripple current, 105°C
C7	0.1-0.22uF, 450V	Surge voltage suppression capacitor – Polyester/Polypropylene film (Note 9)
CSF	1000pF, 50V	Short circuit detection filter capacitor – Multilayer Ceramic (Note 6, Note 7)
RSF	1.8k ohm	Short circuit detection filter resistor (Note 6, Note 7)
RSHUNT	5-100 mohm	Current sensing resistor - Non-inductive, temperature stable, tight tolerance (Note 10)
R1	10 ohm	Boot strap supply inrush limiting resistor (Note 5)
R2	330 ohm	Optional control input noise filter (Note 1, Note 2)
R3	10k ohm	Fault output signal pull-up resistor (Note 3)

**Notes:**

- 1) To prevent input signal oscillations minimize wiring length to controller (~2cm). Additional RC filtering (C5 etc.) may be required. If filtering is added be careful to maintain proper dead time. See application notes for details.
- 2) Internal HVIC provides high voltage level shifting allowing direct connection of all six driving signals to the controller.
- 3) FO output is an open collector type. Pull up resistor (R3) should be adjusted to current sink capability of the module.
- 4) C4 sets the fault output duration and lock-out time.  $C4 \cdot 12.2E^{-6} \times t_{FO}$ , 22nF gives ~1.8ms
- 5) Boot strap supply component values must be adjusted depending on the PWM frequency and technique.
- 6) Wiring length associated with RSHUNT, RSF, CSF must be minimized to avoid improper operation of the SC function.
- 7) RSF, CSF set short-circuit protection trip time. Recommend time constant is 1.5us-2.0us. See application notes.
- 8) Local decoupling/high frequency filter capacitors must be connected as close as possible to the modules pins.
- 9) The length of the DC link wiring between C6, C7, the DIP's P terminal and the shunt must be minimized to prevent excessive transient voltages. In particular C7 should be mounted as close to the DIP as possible.
- 10) Use high quality, tight tolerance current sensing resistor. Connect resistor as close as possible to the DIP's N terminal. Be careful to check for proper power rating. See application notes for calculation of resistance value.