

Triple phase leg MOSFET Power Module

$V_{DSS} = 100V$
 $R_{DSon} = 09m\Omega \text{ typ @ } T_j = 25^\circ C$
 $I_D = 139A \text{ @ } T_c = 25^\circ C$

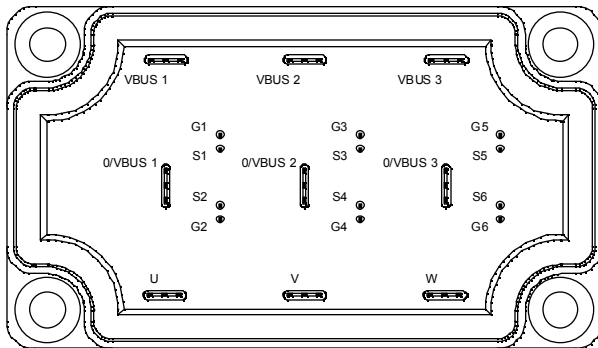
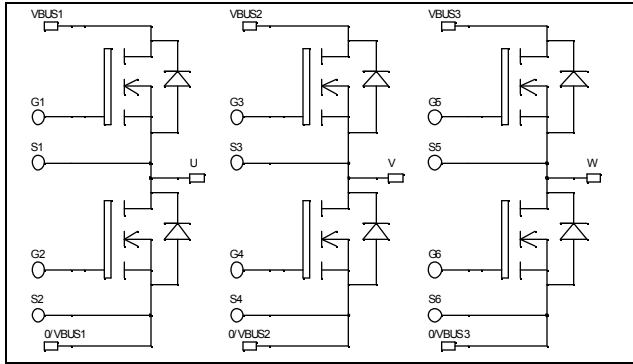

Application

- Welding converters
- Switched Mode Power Supplies
- Uninterruptible Power Supplies
- Motor control

Features

- Power MOS V[®] FREDFETs
 - Low R_{DSon}
 - Low input and Miller capacitance
 - Low gate charge
 - Fast intrinsic diode
 - Avalanche energy rated
 - Very rugged
- Kelvin source for easy drive
- Very low stray inductance
 - Symmetrical design
 - Lead frames for power connections
- High level of integration

Benefits

- Outstanding performance at high frequency operation
- Direct mounting to heatsink (isolated package)
- Low junction to case thermal resistance
- Solderable terminals both for power and signal for easy PCB mounting
- Very low (12mm) profile
- Each leg can be easily paralleled to achieve a phase leg of three times the current capability
- Module can be configured as a three phase bridge
- Module can be configured as a boost followed by a full bridge
- RoHS Compliant

Absolute maximum ratings

Symbol	Parameter	Max ratings	Unit
V_{DSS}	Drain - Source Breakdown Voltage	100	V
I_D	Continuous Drain Current	$T_c = 25^\circ C$	139
		$T_c = 80^\circ C$	100
I_{DM}	Pulsed Drain current	430	
V_{GS}	Gate - Source Voltage	± 30	V
R_{DSon}	Drain - Source ON Resistance	10	$m\Omega$
P_D	Maximum Power Dissipation	$T_c = 25^\circ C$	390
I_{AR}	Avalanche current (repetitive and non repetitive)	100	A
E_{AR}	Repetitive Avalanche Energy	50	mJ
E_{AS}	Single Pulse Avalanche Energy	3000	

CAUTION: These Devices are sensitive to Electrostatic Discharge. Proper Handling Procedures Should Be Followed. See application note APT0502 on www.microsemi.com

All ratings @ $T_j = 25^\circ\text{C}$ unless otherwise specified

Electrical Characteristics

Symbol	Characteristic	Test Conditions	Min	Typ	Max	Unit
I_{DSS}	Zero Gate Voltage Drain Current	$V_{GS} = 0\text{V}, V_{DS} = 100\text{V}$			100	μA
		$T_j = 25^\circ\text{C}$				
		$V_{GS} = 0\text{V}, V_{DS} = 80\text{V}$			500	
$R_{DS(on)}$	Drain – Source on Resistance	$V_{GS} = 10\text{V}, I_D = 69.5\text{A}$		9	10	$\text{m}\Omega$
$V_{GS(th)}$	Gate Threshold Voltage	$V_{GS} = V_{DS}, I_D = 2.5\text{mA}$	2		4	V
I_{GSS}	Gate – Source Leakage Current	$V_{GS} = \pm 30\text{V}, V_{DS} = 0\text{V}$			± 100	nA

Dynamic Characteristics

Symbol	Characteristic	Test Conditions	Min	Typ	Max	Unit
C_{iss}	Input Capacitance	$V_{GS} = 0\text{V}$		9875		pF
C_{oss}	Output Capacitance	$V_{DS} = 25\text{V}$		3940		
C_{rss}	Reverse Transfer Capacitance	$f = 1\text{MHz}$		1470		
Q_g	Total gate Charge	$V_{GS} = 10\text{V}$		350		nC
Q_{gs}	Gate – Source Charge	$V_{Bus} = 50\text{V}$		60		
Q_{gd}	Gate – Drain Charge	$I_D = 139\text{A}$		180		
$T_{d(on)}$	Turn-on Delay Time	Inductive switching @ 125°C $V_{GS} = 15\text{V}$ $V_{Bus} = 66\text{V}$ $I_D = 139\text{A}$ $R_G = 5\Omega$		35		ns
T_r	Rise Time			70		
$T_{d(off)}$	Turn-off Delay Time			95		
T_f	Fall Time			125		
E_{on}	Turn-on Switching Energy	Inductive switching @ 25°C $V_{GS} = 15\text{V}, V_{Bus} = 66\text{V}$ $I_D = 139\text{A}, R_G = 5\Omega$		552		μJ
E_{off}	Turn-off Switching Energy			604		
E_{on}	Turn-on Switching Energy	Inductive switching @ 125°C $V_{GS} = 15\text{V}, V_{Bus} = 66\text{V}$ $I_D = 139\text{A}, R_G = 5\Omega$		608		μJ
E_{off}	Turn-off Switching Energy			641		

Source - Drain diode ratings and characteristics

Symbol	Characteristic	Test Conditions	Min	Typ	Max	Unit	
I_S	Continuous Source current (Body diode)	$T_c = 25^\circ\text{C}$			139	A	
		$T_c = 80^\circ\text{C}$			100		
V_{SD}	Diode Forward Voltage	$V_{GS} = 0\text{V}, I_S = -139\text{A}$			1.3	V	
dv/dt	Peak Diode Recovery 1				8	V/ns	
t_{rr}	Reverse Recovery Time	$I_S = -139\text{A}$ $V_R = 66\text{V}$ $di/dt = 100\text{A}/\mu\text{s}$	$T_j = 25^\circ\text{C}$			190	ns
			$T_j = 125^\circ\text{C}$			370	
Q_{rr}	Reverse Recovery Charge	$I_S = -139\text{A}$ $V_R = 66\text{V}$ $di/dt = 100\text{A}/\mu\text{s}$	$T_j = 25^\circ\text{C}$		0.4	μC	
			$T_j = 125^\circ\text{C}$		1.7		

1 dv/dt numbers reflect the limitations of the circuit rather than the device itself.

$$I_S \leq -139\text{A} \quad di/dt \leq 700\text{A}/\mu\text{s} \quad V_R \leq V_{DSS} \quad T_j \leq 150^\circ\text{C}$$

Thermal and package characteristics

Symbol	Characteristic	Min	Typ	Max	Unit	
R_{thJC}	Junction to Case Thermal Resistance			0.32	°C/W	
V_{ISOL}	RMS Isolation Voltage, any terminal to case t=1 min, I _{isol} <1mA, 50/60Hz	2500			V	
T_J	Operating junction temperature range	-40		150	°C	
T_{STG}	Storage Temperature Range	-40		125		
T_C	Operating Case Temperature	-40		100		
Torque	Mounting torque	To heatsink	M6	3	5	N.m
Wt	Package Weight				250	g

SP6-P Package outline (dimensions in mm)

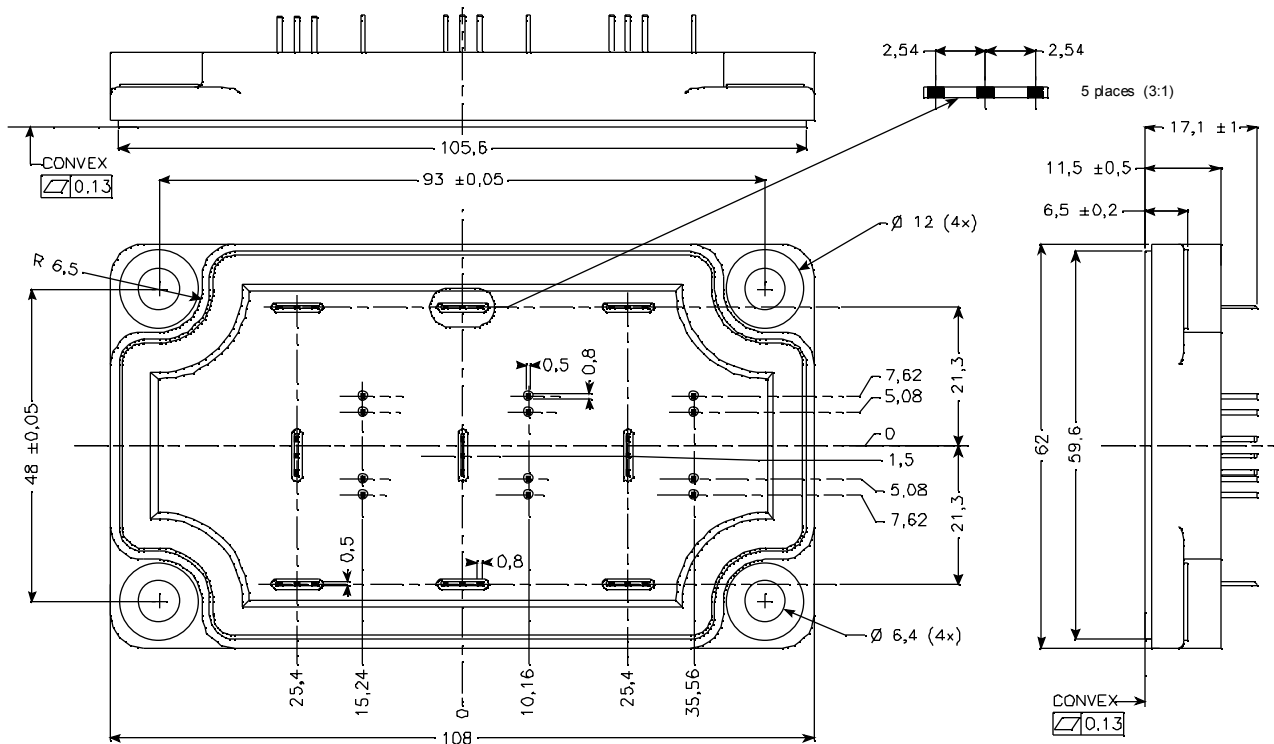

See application note 1902 - Mounting Instructions for SP6-P (12mm) Power Modules on www.microsemi.com

Typical Performance Curve

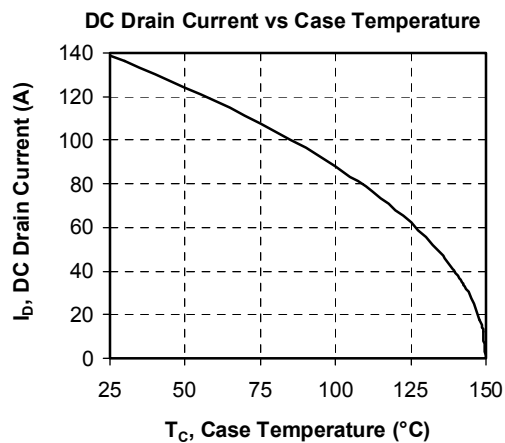
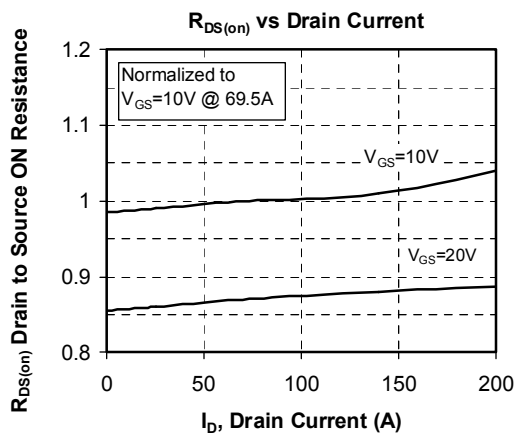
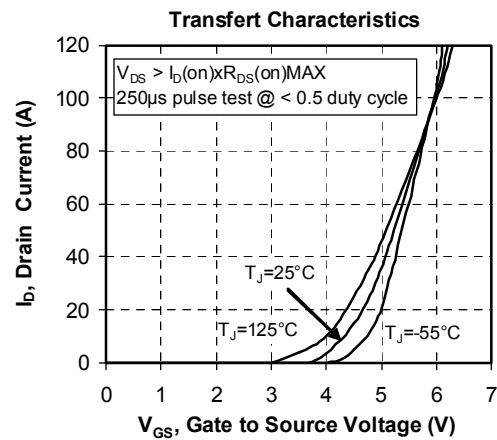
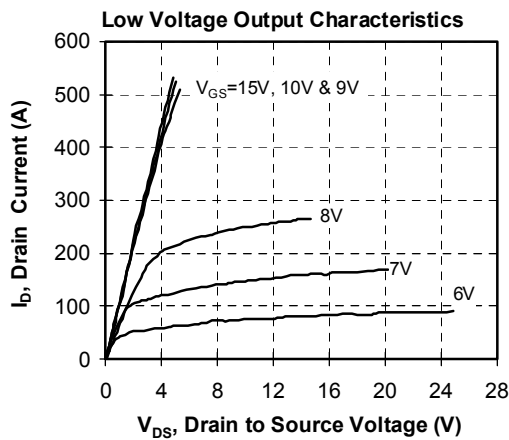
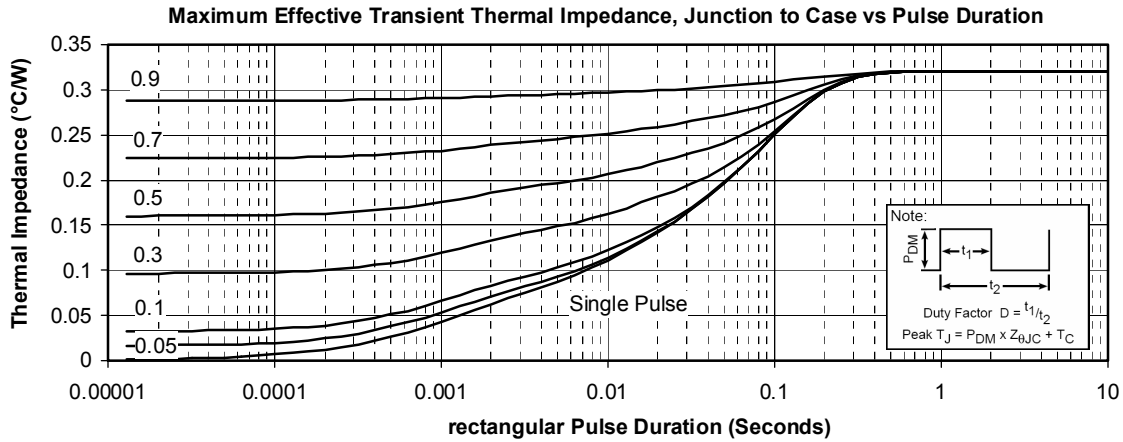

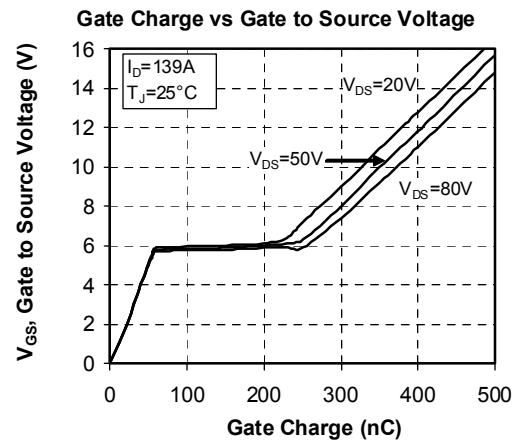
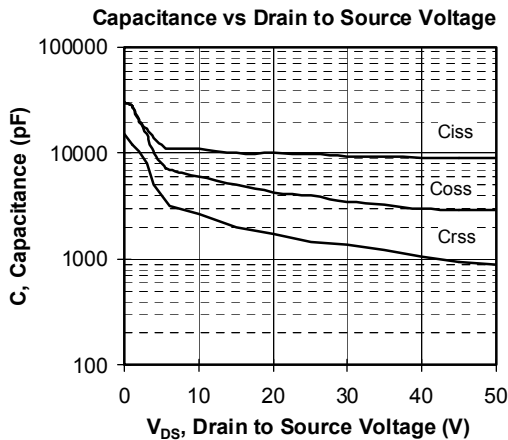
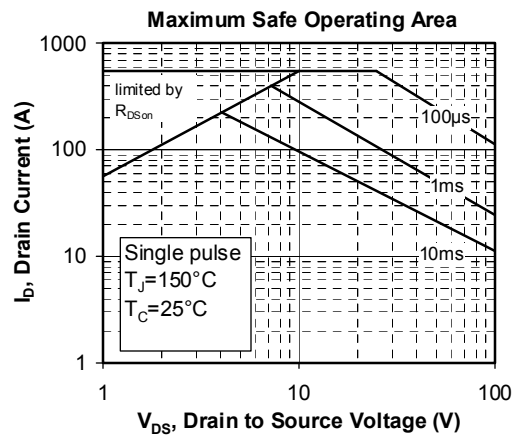
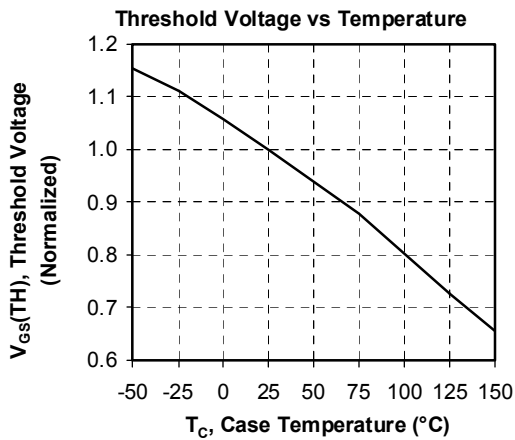
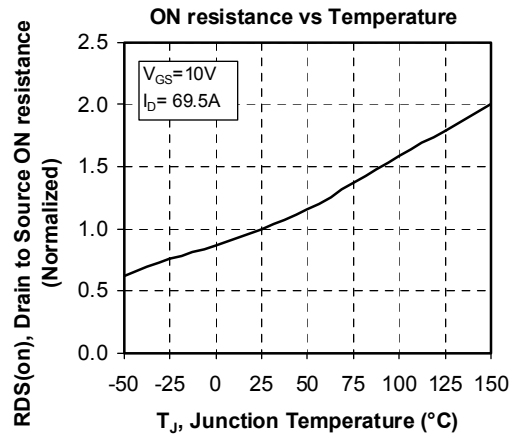
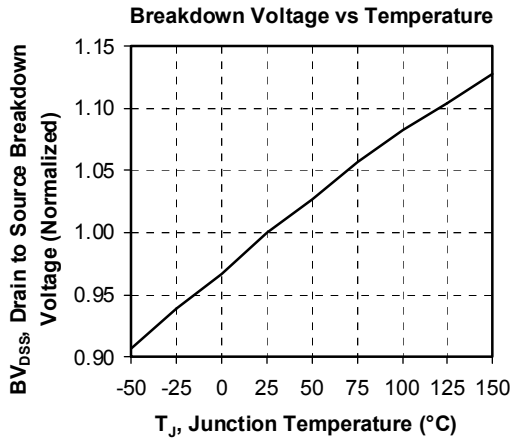

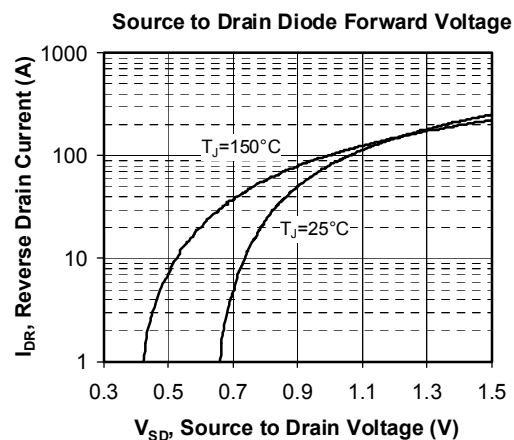
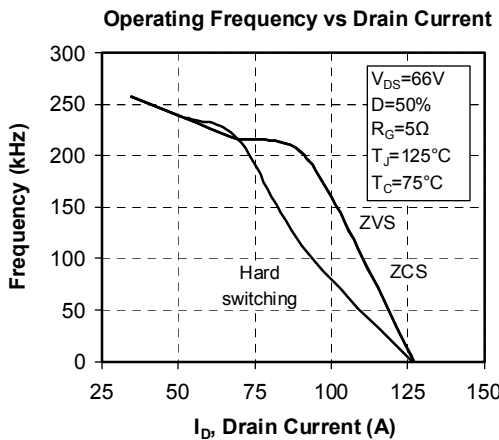
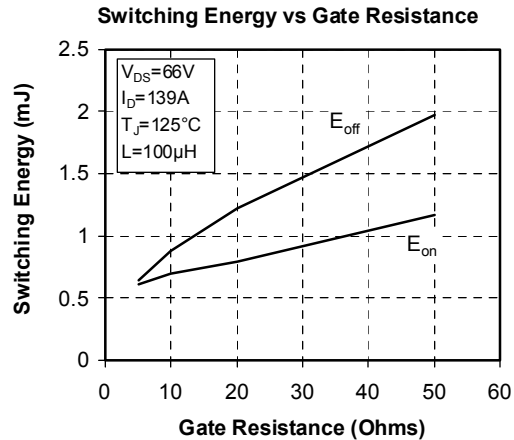
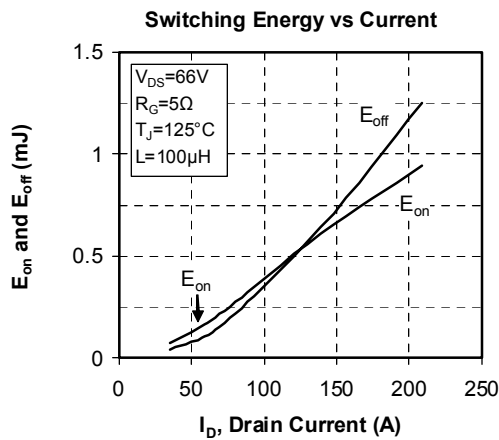
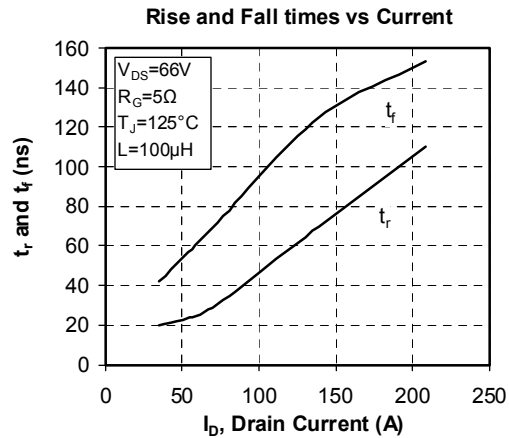
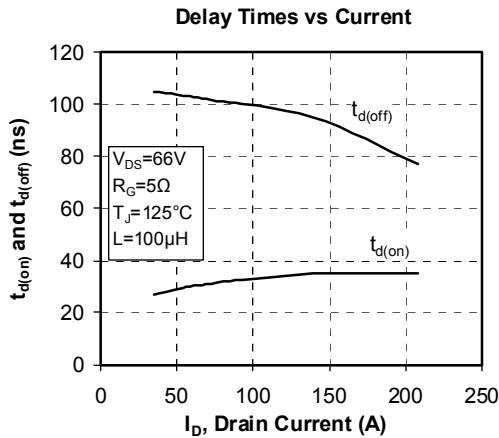

Microsemi reserves the right to change, without notice, the specifications and information contained herein

Microsemi's products are covered by one or more of U.S. patents 4,895,810 5,045,903 5,089,434 5,182,234 5,019,522 5,262,336 6,503,786 5,256,583 4,748,103 5,283,202 5,231,474 5,434,095 5,528,058 and foreign patents. U.S. and Foreign patents pending. All Rights Reserved.