

*Full bridge
Series & parallel diodes
MOSFET Power Module*

$V_{DSS} = 1000V$

$R_{DSon} = 450m\Omega$ typ @ $T_j = 25^\circ C$

$I_D = 18A$ @ $T_c = 25^\circ C$

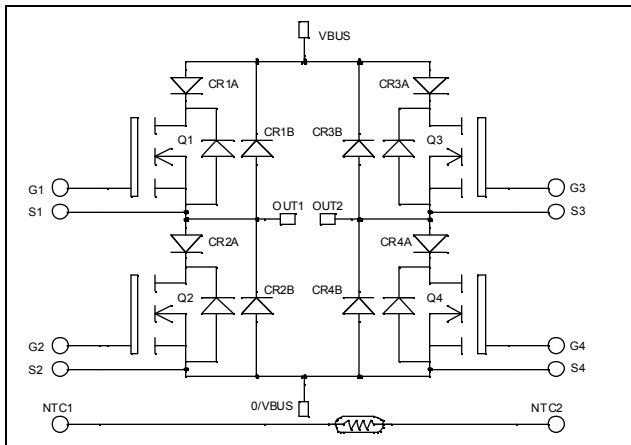

Application

- Motor control
- Switched Mode Power Supplies
- Uninterruptible Power Supplies

Features

- Power MOS 7[®] MOSFETs
 - Low R_{DSon}
 - Low input and Miller capacitance
 - Low gate charge
 - Avalanche energy rated
 - Very rugged
- Kelvin source for easy drive
- Very low stray inductance
 - Symmetrical design
 - Lead frames for power connections
- Internal thermistor for temperature monitoring
- High level of integration

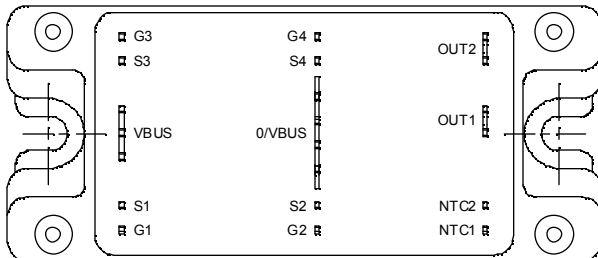

Benefits

- Outstanding performance at high frequency operation
- Direct mounting to heatsink (isolated package)
- Low junction to case thermal resistance
- Solderable terminals both for power and signal for easy PCB mounting
- Low profile
- RoHS Compliant

Absolute maximum ratings

| Symbol | Parameter | Max ratings | Unit |
|------------|---|--------------------|------------|
| V_{DSS} | Drain - Source Breakdown Voltage | 1000 | V |
| I_D | Continuous Drain Current | $T_c = 25^\circ C$ | 18 |
| | | $T_c = 80^\circ C$ | 14 |
| I_{DM} | Pulsed Drain current | 72 | A |
| V_{GS} | Gate - Source Voltage | ± 30 | V |
| R_{DSon} | Drain - Source ON Resistance | 540 | m Ω |
| P_D | Maximum Power Dissipation | $T_c = 25^\circ C$ | 357 |
| I_{AR} | Avalanche current (repetitive and non repetitive) | 18 | A |
| E_{AR} | Repetitive Avalanche Energy | 50 | mJ |
| E_{AS} | Single Pulse Avalanche Energy | 2500 | |

CAUTION: These Devices are sensitive to Electrostatic Discharge. Proper Handling Procedures Should Be Followed. See application note APT0502 on www.microsemi.com

All ratings @ $T_j = 25^\circ\text{C}$ unless otherwise specified

Electrical Characteristics

| Symbol | Characteristic | Test Conditions | Min | Typ | Max | Unit |
|--------------|---------------------------------|---|-----|-----|-----------|------------------|
| I_{DSS} | Zero Gate Voltage Drain Current | $V_{GS} = 0\text{V}, V_{DS} = 1000\text{V}$ | | | 100 | μA |
| | | $V_{GS} = 0\text{V}, V_{DS} = 800\text{V}$ | | | 500 | |
| $R_{DS(on)}$ | Drain – Source on Resistance | $V_{GS} = 10\text{V}, I_D = 9\text{A}$ | | 450 | 540 | $\text{m}\Omega$ |
| $V_{GS(th)}$ | Gate Threshold Voltage | $V_{GS} = V_{DS}, I_D = 2.5\text{mA}$ | 3 | | 5 | V |
| I_{GSS} | Gate – Source Leakage Current | $V_{GS} = \pm 30\text{V}, V_{DS} = 0\text{V}$ | | | ± 100 | nA |

Dynamic Characteristics

| Symbol | Characteristic | Test Conditions | Min | Typ | Max | Unit |
|--------------|------------------------------|--|-----|------|-----|---------------|
| C_{iss} | Input Capacitance | $V_{GS} = 0\text{V}$ | | 4350 | | pF |
| C_{oss} | Output Capacitance | $V_{DS} = 25\text{V}$ | | 715 | | |
| C_{rss} | Reverse Transfer Capacitance | $f = 1\text{MHz}$ | | 120 | | |
| Q_g | Total gate Charge | $V_{GS} = 10\text{V}$ | | 154 | | nC |
| Q_{gs} | Gate – Source Charge | $V_{Bus} = 500\text{V}$ | | 26 | | |
| Q_{gd} | Gate – Drain Charge | $I_D = 18\text{A}$ | | 97 | | |
| $T_{d(on)}$ | Turn-on Delay Time | Inductive switching @ 125°C $V_{GS} = 15\text{V}$ $V_{Bus} = 667\text{V}$ $I_D = 18\text{A}$ $R_G = 5\Omega$ | | 10 | | ns |
| T_r | Rise Time | | | 12 | | |
| $T_{d(off)}$ | Turn-off Delay Time | | | 121 | | |
| T_f | Fall Time | | | 35 | | |
| E_{on} | Turn-on Switching Energy | Inductive switching @ 25°C $V_{GS} = 15\text{V}, V_{Bus} = 667\text{V}$ $I_D = 18\text{A}, R_G = 5\Omega$ | | 639 | | μJ |
| E_{off} | Turn-off Switching Energy | | | 380 | | |
| E_{on} | Turn-on Switching Energy | Inductive switching @ 125°C $V_{GS} = 15\text{V}, V_{Bus} = 667\text{V}$ $I_D = 18\text{A}, R_G = 5\Omega$ | | 1046 | | μJ |
| E_{off} | Turn-off Switching Energy | | | 451 | | |

Series diode ratings and characteristics

| Symbol | Characteristic | Test Conditions | Min | Typ | Max | Unit |
|-----------|---|--|---------------------------|-----|------|---------------|
| V_{RRM} | Maximum Peak Repetitive Reverse Voltage | | 200 | | | V |
| I_{RM} | Maximum Reverse Leakage Current | $V_R = 200\text{V}$ | $T_j = 25^\circ\text{C}$ | | 250 | μA |
| | | | $T_j = 125^\circ\text{C}$ | | 500 | |
| I_F | DC Forward Current | | | 30 | | A |
| V_F | Diode Forward Voltage | $I_F = 30\text{A}$ | | 1.1 | 1.15 | V |
| | | $I_F = 60\text{A}$ | | 1.4 | | |
| | | $I_F = 30\text{A}$ | $T_j = 125^\circ\text{C}$ | 0.9 | | |
| t_{rr} | Reverse Recovery Time | $I_F = 30\text{A}$ $V_R = 133\text{V}$ $di/dt = 200\text{A}/\mu\text{s}$ | $T_j = 25^\circ\text{C}$ | | 24 | ns |
| | | | $T_j = 125^\circ\text{C}$ | | 48 | |
| Q_{rr} | Reverse Recovery Charge | $I_F = 30\text{A}$ $V_R = 133\text{V}$ $di/dt = 200\text{A}/\mu\text{s}$ | $T_j = 25^\circ\text{C}$ | | 33 | nC |
| | | | $T_j = 125^\circ\text{C}$ | | 150 | |

Parallel diode ratings and characteristics

| Symbol | Characteristic | Test Conditions | | Min | Typ | Max | Unit |
|------------------|---|--|------------------------|------------------------|-----|------|------|
| V _{RRM} | Maximum Peak Repetitive Reverse Voltage | | | 1000 | | | V |
| I _{RM} | Maximum Reverse Leakage Current | V _R =1000V | T _j = 25°C | | | 250 | μA |
| | | | T _j = 125°C | | | 500 | |
| I _F | DC Forward Current | T _c = 65°C | | | 30 | | A |
| V _F | Diode Forward Voltage | I _F = 30A | | | 1.9 | 2.3 | V |
| | | I _F = 60A | | | 2.2 | | |
| | | I _F = 30A | T _j = 125°C | | 1.7 | | |
| t _{rr} | Reverse Recovery Time | I _F = 30A V _R = 667V di/dt = 200A/μs | T _j = 25°C | | 290 | | ns |
| | | | T _j = 125°C | | 390 | | |
| Q _{rr} | Reverse Recovery Charge | | | T _j = 25°C | | 670 | nC |
| | | | | T _j = 125°C | | 2350 | |

Thermal and package characteristics

| Symbol | Characteristic | | | Min | Typ | Max | Unit |
|-------------------|---|-------------|----|------|-----|------|------|
| R _{thJC} | Junction to Case Thermal Resistance | Transistor | | | | 0.35 | °C/W |
| | | Diode | | | | 1.2 | |
| V _{ISOL} | RMS Isolation Voltage, any terminal to case t = 1 min, I _{isol} < 1mA, 50/60Hz | | | 2500 | | | V |
| T _J | Operating junction temperature range | | | -40 | | 150 | °C |
| T _{STG} | Storage Temperature Range | | | -40 | | 125 | |
| T _C | Operating Case Temperature | | | -40 | | 100 | |
| Torque | Mounting torque | To Heatsink | M5 | 2.5 | | 4.7 | N.m |
| Wt | Package Weight | | | | | 160 | g |

Temperature sensor NTC (see application note APT0406 on www.microsemi.com for more information).

| Symbol | Characteristic | Min | Typ | Max | Unit |
|--------------------|----------------------------|-----|------|-----|------|
| R ₂₅ | Resistance @ 25°C | | 50 | | kΩ |
| B _{25/85} | T ₂₅ = 298.15 K | | 3952 | | K |

$$R_T = \frac{R_{25}}{\exp\left[B_{25/85}\left(\frac{1}{T_{25}} - \frac{1}{T}\right)\right]}$$

T: Thermistor temperature
R_T: Thermistor value at T

SP4 Package outline (dimensions in mm)

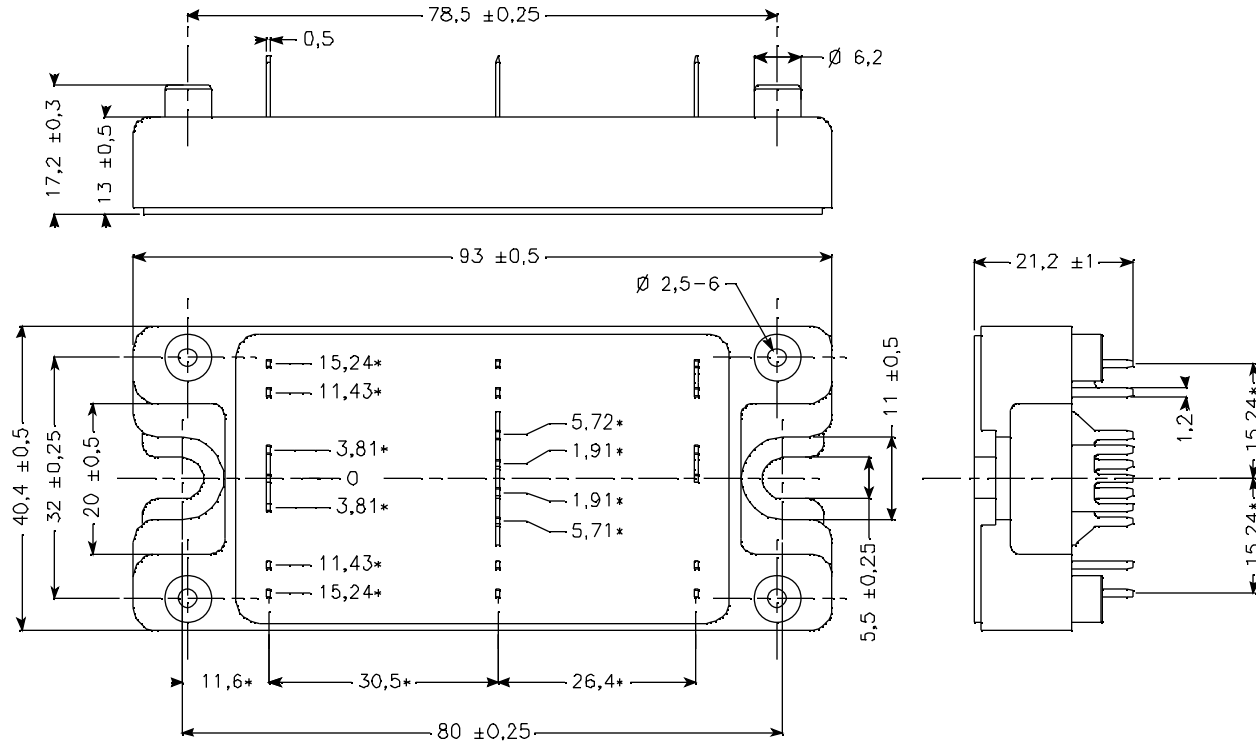

ALL DIMENSIONS MARKED "*" ARE TOLERANCED AS : $\varnothing 1$

See application note APT0501 - Mounting Instructions for SP4 Power Modules on www.microsemi.com

Typical Performance Curve

Maximum Effective Transient Thermal Impedance, Junction to Case vs Pulse Duration

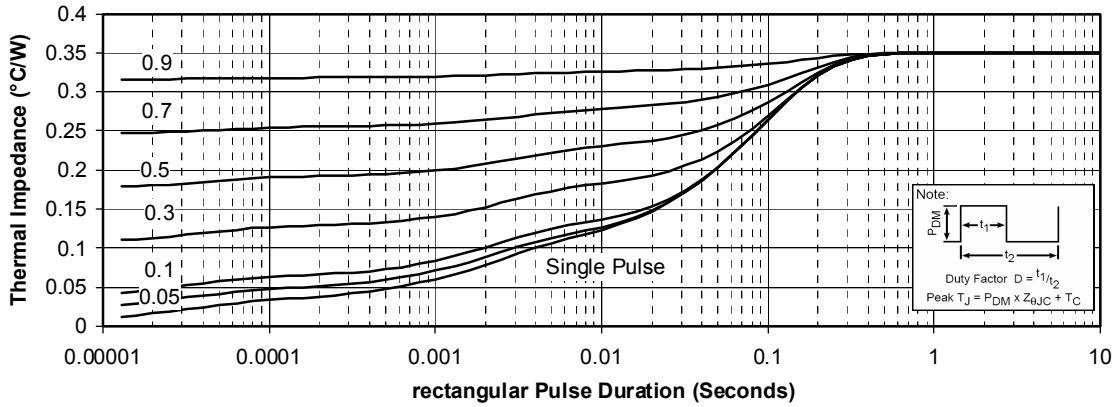

Low Voltage Output Characteristics

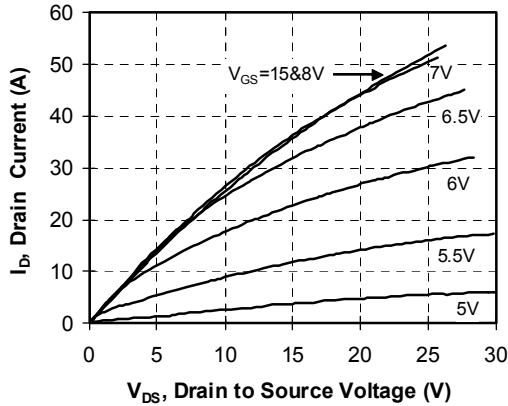

Transfer Characteristics

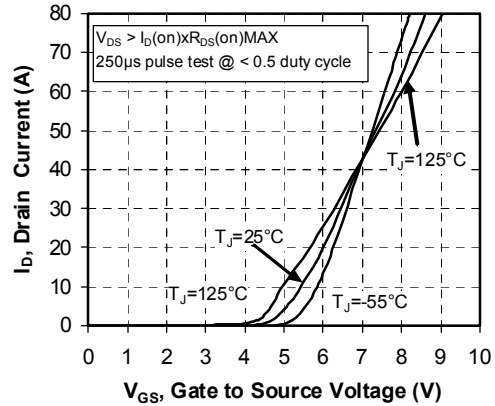

RDS(on) vs Drain Current

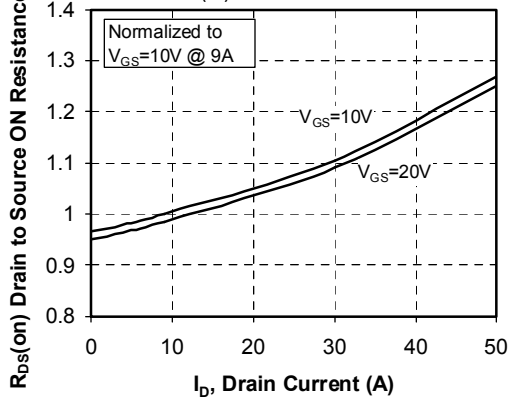

DC Drain Current vs Case Temperature

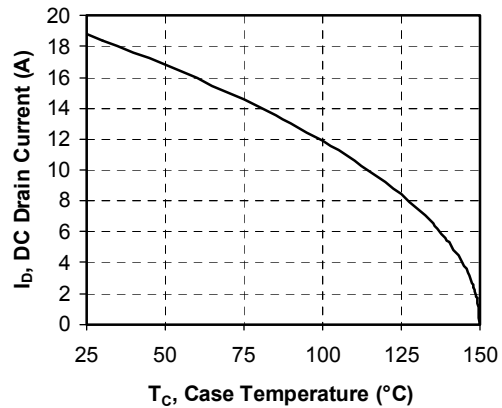

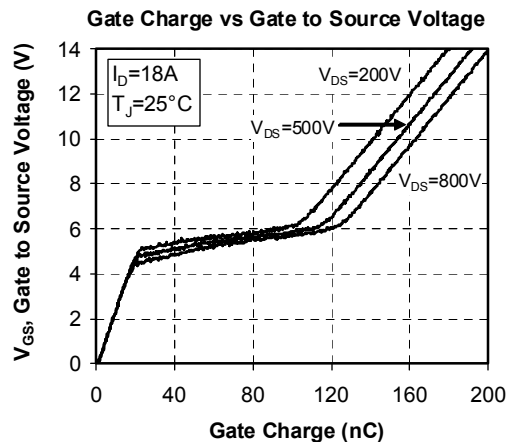
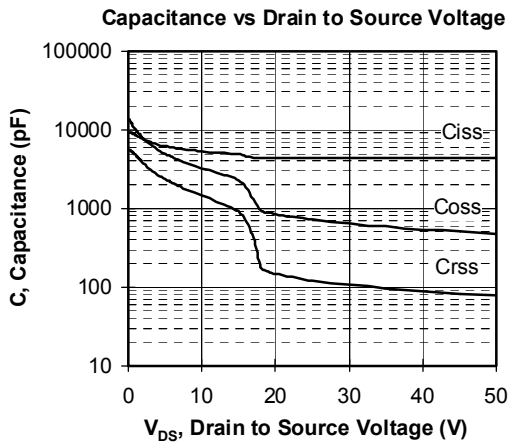
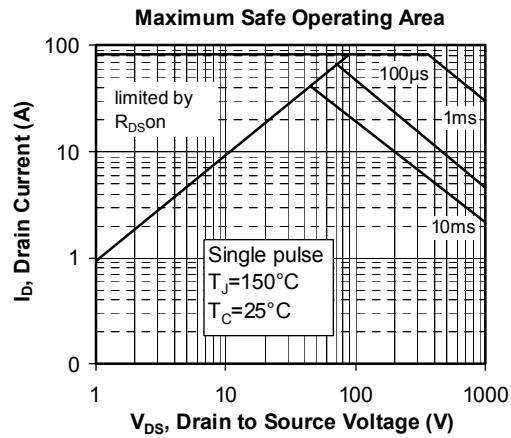
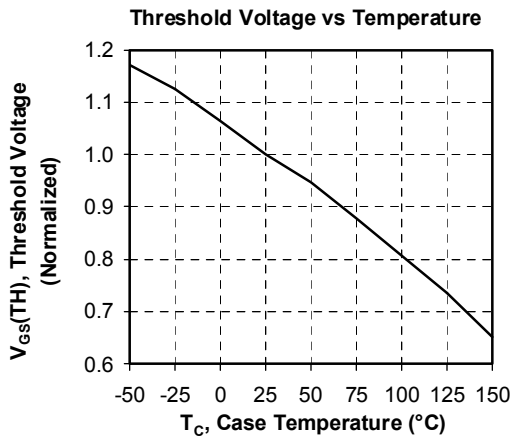
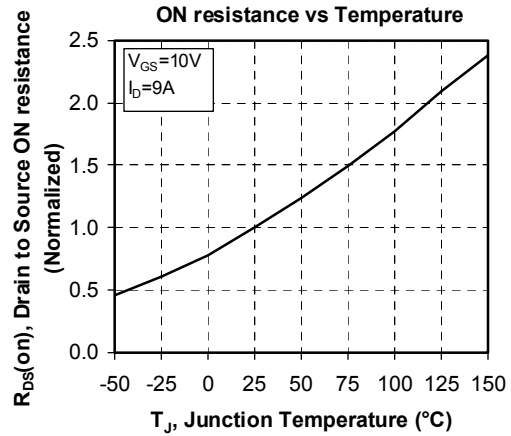
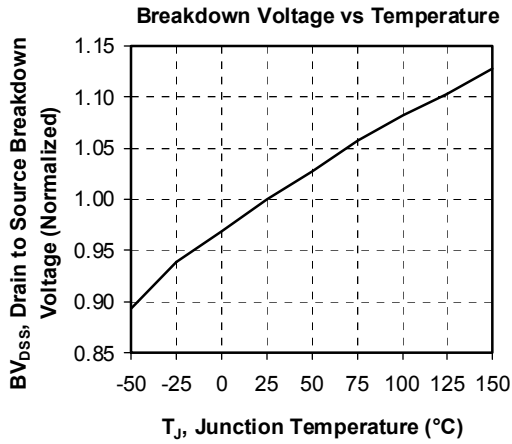

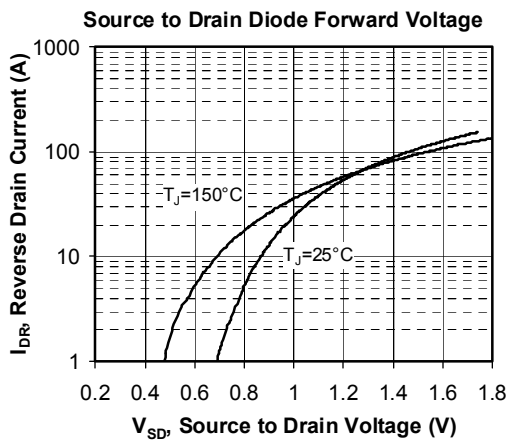
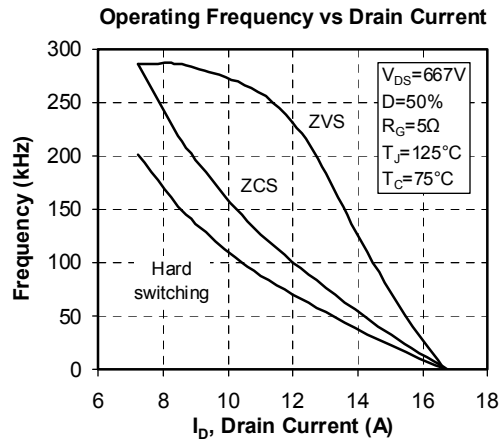
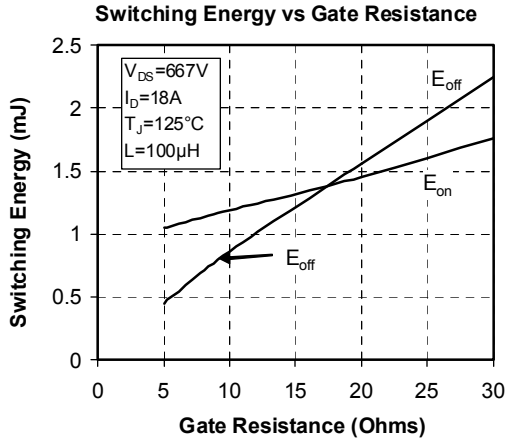
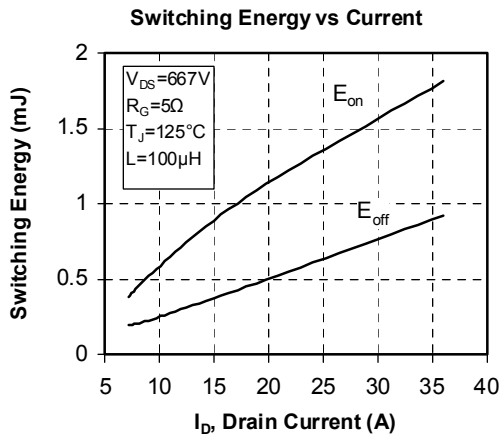
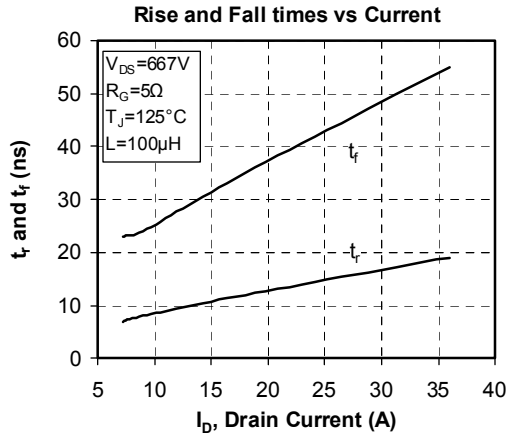
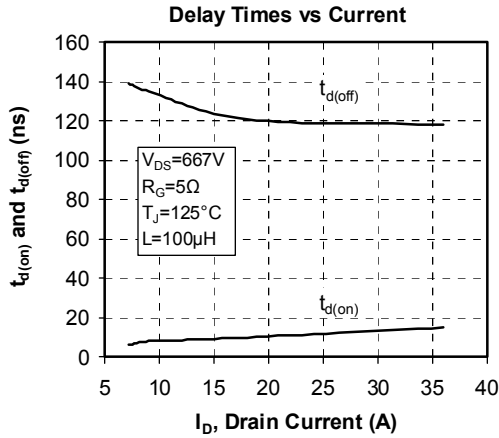

Microsemi reserves the right to change, without notice, the specifications and information contained herein

Microsemi's products are covered by one or more of U.S. patents 4,895,810 5,045,903 5,089,434 5,182,234 5,019,522 5,262,336 6,503,786 5,256,583 4,748,103 5,283,202 5,231,474 5,434,095 5,528,058 and foreign patents. U.S. and Foreign patents pending. All Rights Reserved.