

Triple dual common source MOSFET Power Module

$V_{DSS} = 100V$
 $R_{DSon} = 19m\Omega \text{ typ @ } T_j = 25^\circ C$
 $I_D = 70A \text{ @ } T_c = 25^\circ C$

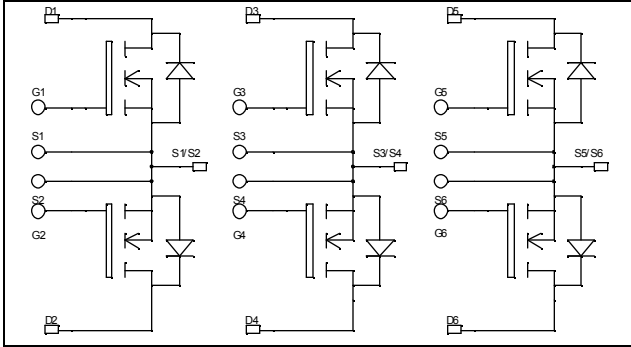

Application

- AC Switches
- Switched Mode Power Supplies
- Uninterruptible Power Supplies

Features

- Power MOS V[®] MOSFETs
 - Low R_{DSon}
 - Low input and Miller capacitance
 - Low gate charge
 - Avalanche energy rated
 - Very rugged
- Kelvin source for easy drive
- Very low stray inductance
 - Symmetrical design
 - Lead frames for power connections
- High level of integration

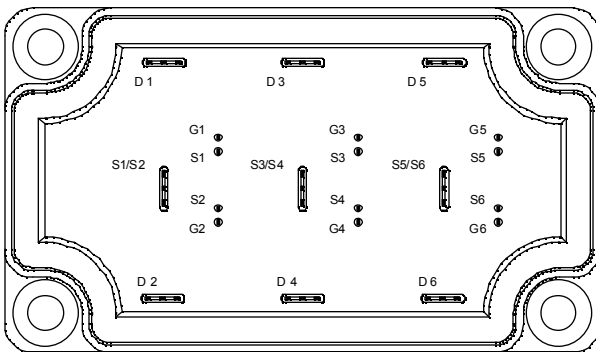

Benefits

- Outstanding performance at high frequency operation
- Direct mounting to heatsink (isolated package)
- Low junction to case thermal resistance
- Solderable terminals both for power and signal for easy PCB mounting
- Very low (12mm) profile
- Each leg can be easily paralleled to achieve a dual common source configuration of three times the current capability
- RoHS Compliant

Absolute maximum ratings

Symbol	Parameter	Max ratings	Unit
V_{DSS}	Drain - Source Breakdown Voltage	100	V
I_D	Continuous Drain Current	$T_c = 25^\circ C$	70
		$T_c = 80^\circ C$	50
I_{DM}	Pulsed Drain current	300	
V_{GS}	Gate - Source Voltage	± 30	V
R_{DSon}	Drain - Source ON Resistance	21	$m\Omega$
P_D	Maximum Power Dissipation	$T_c = 25^\circ C$	208
I_{AR}	Avalanche current (repetitive and non repetitive)	75	A
E_{AR}	Repetitive Avalanche Energy	30	mJ
E_{AS}	Single Pulse Avalanche Energy	1500	

CAUTION: These Devices are sensitive to Electrostatic Discharge. Proper Handling Procedures Should Be Followed. See application note APT0502 on www.microsemi.com

All ratings @ $T_j = 25^\circ\text{C}$ unless otherwise specified

Electrical Characteristics

Symbol	Characteristic	Test Conditions	Min	Typ	Max	Unit
I_{DSS}	Zero Gate Voltage Drain Current	$V_{GS} = 0\text{V}, V_{DS} = 100\text{V}$			250	μA
		$V_{GS} = 0\text{V}, V_{DS} = 80\text{V}$			1000	
$R_{DS(on)}$	Drain – Source on Resistance	$V_{GS} = 10\text{V}, I_D = 35\text{A}$		19	21	$\text{m}\Omega$
$V_{GS(th)}$	Gate Threshold Voltage	$V_{GS} = V_{DS}, I_D = 1\text{mA}$	2		4	V
I_{GSS}	Gate – Source Leakage Current	$V_{GS} = \pm 30\text{V}, V_{DS} = 0\text{V}$			± 100	nA

Dynamic Characteristics

Symbol	Characteristic	Test Conditions	Min	Typ	Max	Unit
C_{iss}	Input Capacitance	$V_{GS} = 0\text{V}$ $V_{DS} = 25\text{V}$ $f = 1\text{MHz}$		5100		pF
C_{oss}	Output Capacitance			1900		
C_{rss}	Reverse Transfer Capacitance			800		
Q_g	Total gate Charge	$V_{GS} = 10\text{V}$ $V_{Bus} = 100\text{V}$ $I_D = 70\text{A}$		200		nC
Q_{gs}	Gate – Source Charge			40		
Q_{gd}	Gate – Drain Charge			92		
$T_{d(on)}$	Turn-on Delay Time	Inductive switching @ 125°C $V_{GS} = 15\text{V}$ $V_{Bus} = 66\text{V}$ $I_D = 70\text{A}$ $R_G = 5\Omega$		35		ns
T_r	Rise Time			70		
$T_{d(off)}$	Turn-off Delay Time			95		
T_f	Fall Time			125		
E_{on}	Turn-on Switching Energy	Inductive switching @ 25°C $V_{GS} = 15\text{V}, V_{Bus} = 66\text{V}$ $I_D = 70\text{A}, R_G = 5\Omega$		276		μJ
E_{off}	Turn-off Switching Energy			302		
E_{on}	Turn-on Switching Energy	Inductive switching @ 125°C $V_{GS} = 15\text{V}, V_{Bus} = 66\text{V}$ $I_D = 70\text{A}, R_G = 5\Omega$		304		μJ
E_{off}	Turn-off Switching Energy			320		

Source - Drain diode ratings and characteristics

Symbol	Characteristic	Test Conditions	Min	Typ	Max	Unit
I_S	Continuous Source current (Body diode)	$T_c = 25^\circ\text{C}$			70	A
		$T_c = 80^\circ\text{C}$			50	
V_{SD}	Diode Forward Voltage	$V_{GS} = 0\text{V}, I_S = -139\text{A}$			1.3	V
dv/dt	Peak Diode Recovery ①				5	V/ns
t_{rr}	Reverse Recovery Time	$I_S = -70\text{A}$ $V_R = 66\text{V}$		$T_j = 25^\circ\text{C}$	200	ns
Q_{rr}	Reverse Recovery Charge	$di/dt = 100\text{A}/\mu\text{s}$		$T_j = 25^\circ\text{C}$	1.4	μC

 ① dv/dt numbers reflect the limitations of the circuit rather than the device itself.

$$I_S \leq -70\text{A} \quad di/dt \leq 700\text{A}/\mu\text{s} \quad V_R \leq V_{DSS} \quad T_j \leq 150^\circ\text{C}$$

Thermal and package characteristics

Symbol Characteristic

Min Typ Max Unit

<i>Symbol</i>	<i>Characteristic</i>	<i>Min</i>	<i>Typ</i>	<i>Max</i>	<i>Unit</i>		
R _{thJC}	Junction to Case Thermal Resistance			0.6	°C/W		
V _{ISOL}	RMS Isolation Voltage, any terminal to case t = 1 min, I _{isol} < 1 mA, 50/60 Hz	2500			V		
T _J	Operating junction temperature range	-40		150	°C		
T _{STG}	Storage Temperature Range	-40		125			
T _C	Operating Case Temperature	-40		100			
Torque	Mounting torque		To heatsink	M6	3	5	N.m
Wt	Package Weight					250	g

SP6-P Package outline (dimensions in mm)

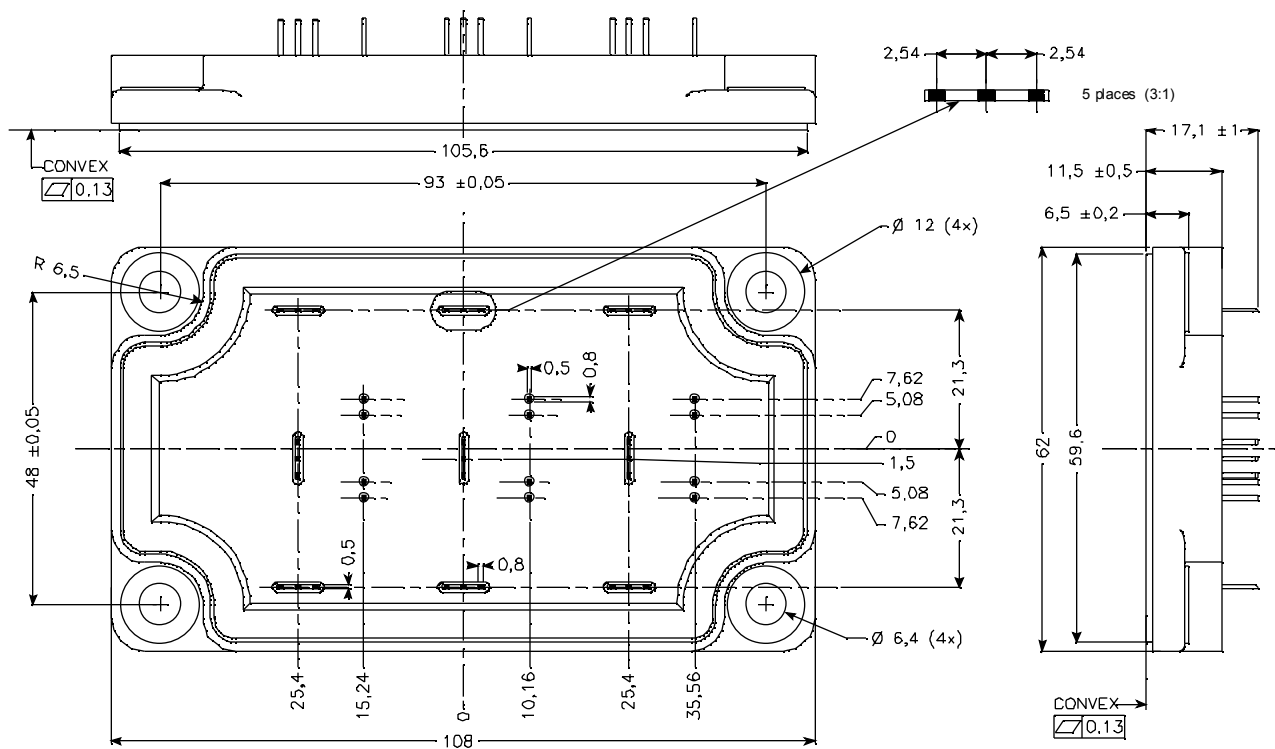

See application note 1902 - Mounting Instructions for SP6-P (12mm) Power Modules on www.microsemi.com

Typical Performance Curve

Maximum Effective Transient Thermal Impedance, Junction to Case vs Pulse Duration

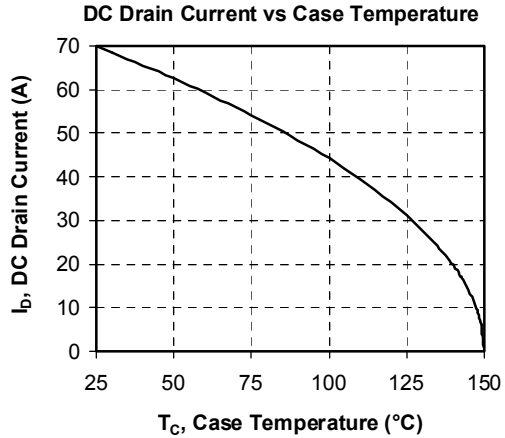
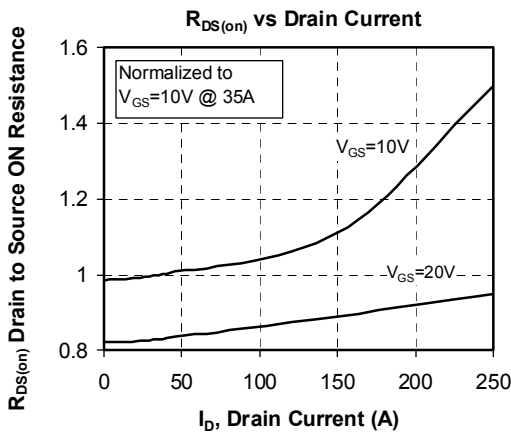
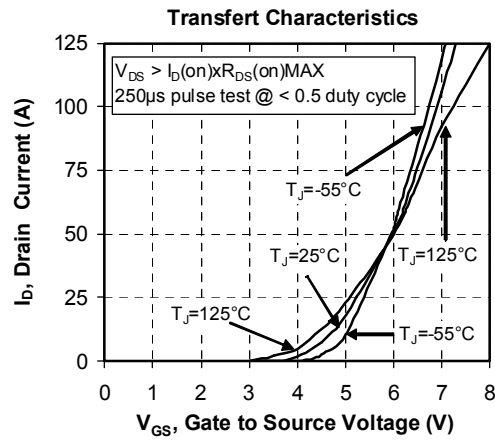
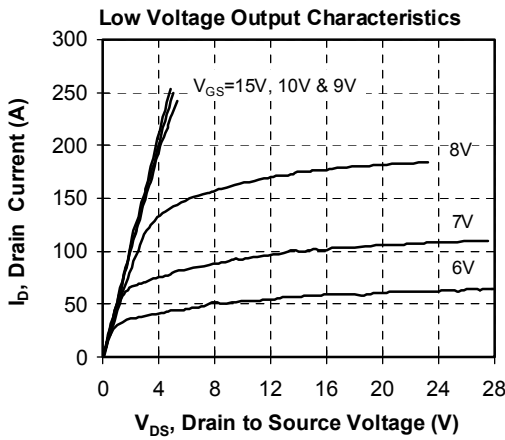
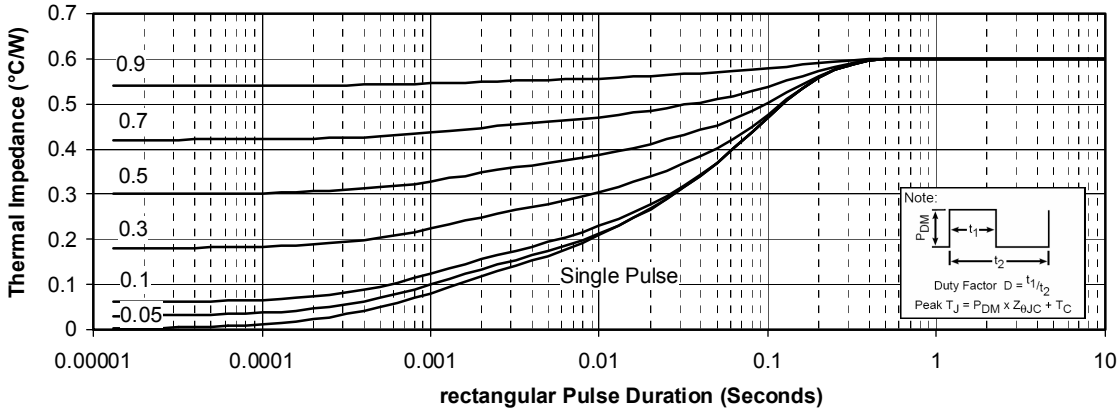

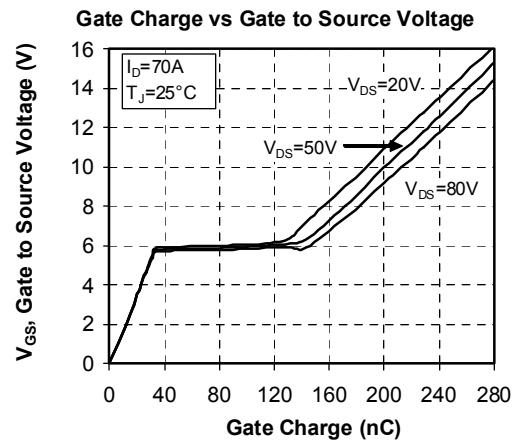
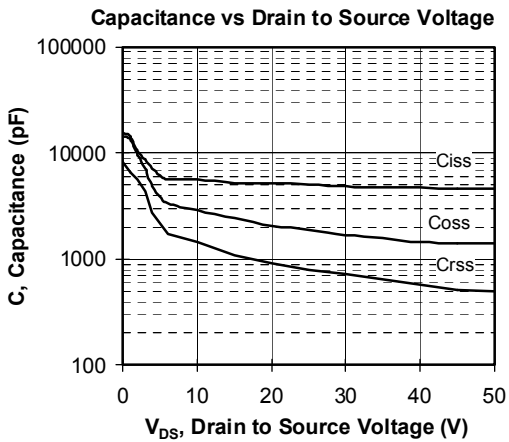
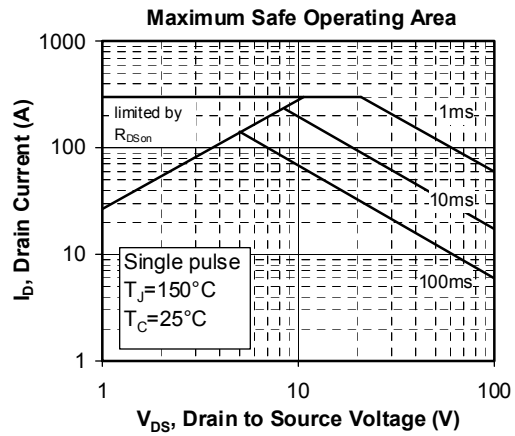
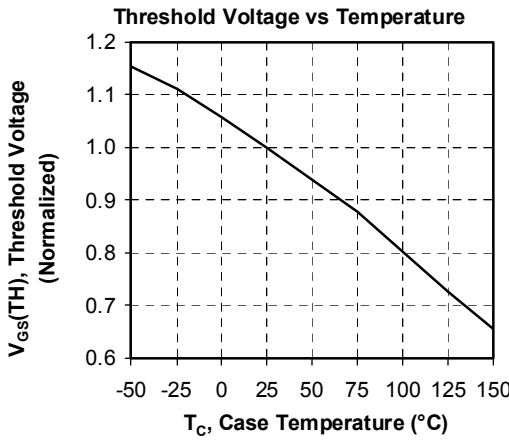
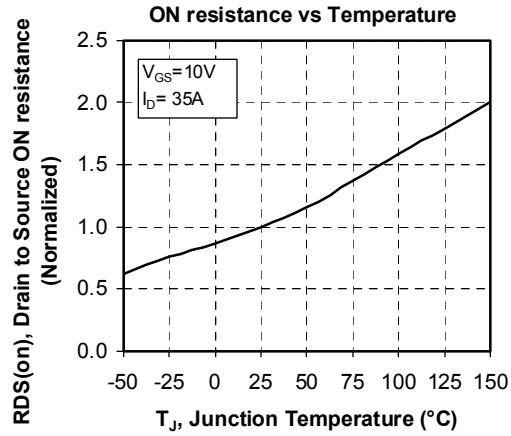
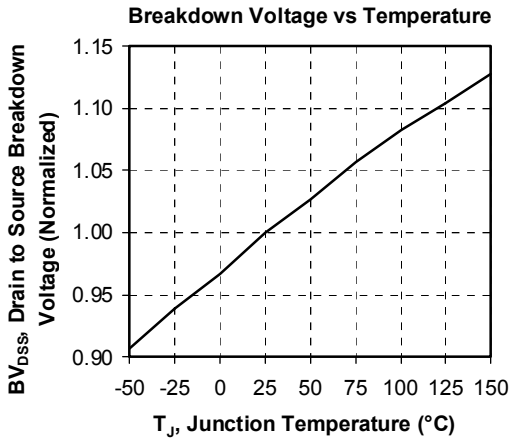

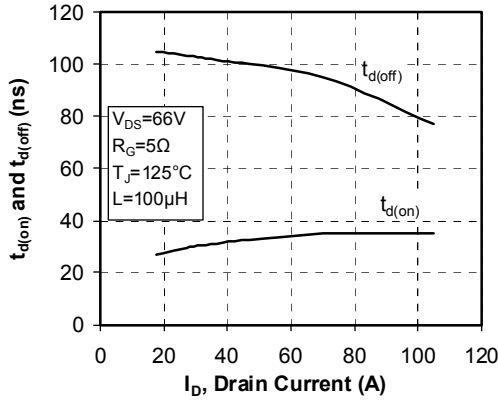
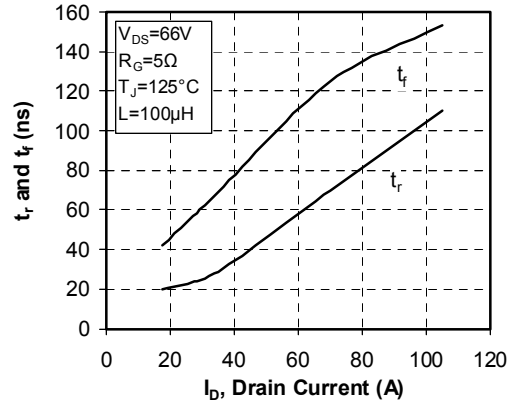
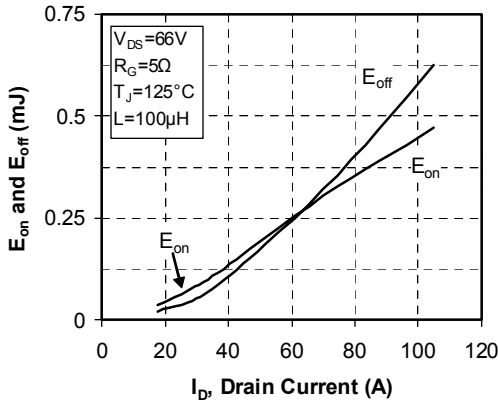
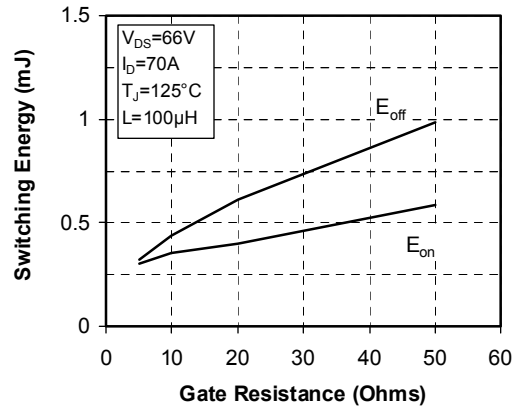
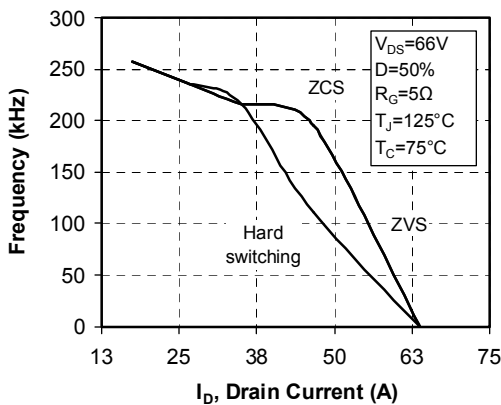
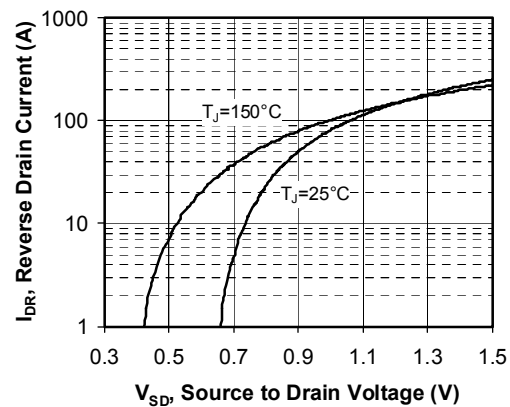
Delay Times vs Current

Rise and Fall times vs Current

Switching Energy vs Current

Switching Energy vs Gate Resistance

Operating Frequency vs Drain Current

Source to Drain Diode Forward Voltage

Microsemi reserves the right to change, without notice, the specifications and information contained herein

Microsemi's products are covered by one or more of U.S. patents 4,895,810 5,045,903 5,089,434 5,182,234 5,019,522 5,262,336 6,503,786 5,256,583 4,748,103 5,283,202 5,231,474 5,434,095 5,528,058 and foreign patents. U.S. and Foreign patents pending. All Rights Reserved.

