

Dual buck chopper Super Junction MOSFET Power Module

$$V_{DSS} = 600V$$

$$R_{DSon} = 35m\Omega \text{ max @ } T_j = 25^\circ C$$

$$I_D = 72A \text{ @ } T_c = 25^\circ C$$

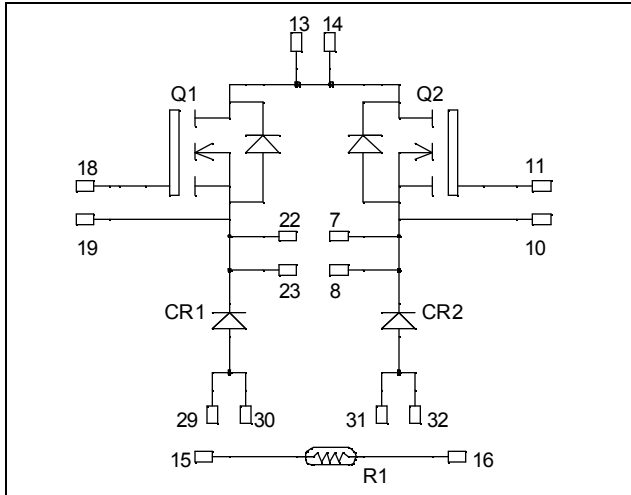

Application

- AC and DC motor control
- Switched Mode Power Supplies

Features

- **COOLMOS** Power Semiconductors
 - Ultra low R_{DSon}
 - Low Miller capacitance
 - Ultra low gate charge
 - Avalanche energy rated
 - Very rugged
- Kelvin source for easy drive
- Very low stray inductance
 - Symmetrical design
- Internal thermistor for temperature monitoring
- High level of integration

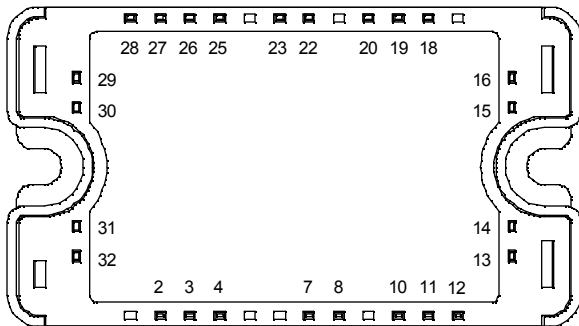

Benefits

- Outstanding performance at high frequency operation
- Direct mounting to heatsink (isolated package)
- Low junction to case thermal resistance
- Solderable terminals both for power and signal for easy PCB mounting
- Low profile
- Each leg can be easily paralleled to achieve a single buck of twice the current capability
- RoHS Compliant

All multiple inputs and outputs must be shorted together
 Example: 13/14 ; 29/30 ; 22/23 ...

Absolute maximum ratings

Symbol	Parameter	Max ratings	Unit
V_{DSS}	Drain - Source Breakdown Voltage	600	V
I_D	Continuous Drain Current	$T_c = 25^\circ C$	72
		$T_c = 80^\circ C$	54
I_{DM}	Pulsed Drain current	288	
V_{GS}	Gate - Source Voltage	± 20	V
R_{DSon}	Drain - Source ON Resistance	35	$m\Omega$
P_D	Maximum Power Dissipation	$T_c = 25^\circ C$	416
I_{AR}	Avalanche current (repetitive and non repetitive)	20	A
E_{AR}	Repetitive Avalanche Energy	1	mJ
E_{AS}	Single Pulse Avalanche Energy	1800	

CAUTION: These Devices are sensitive to Electrostatic Discharge. Proper Handling Procedures Should Be Followed. See application note APT0502 on www.microsemi.com

All ratings @ $T_j = 25^\circ\text{C}$ unless otherwise specified

Electrical Characteristics

Symbol	Characteristic	Test Conditions	Min	Typ	Max	Unit
I_{DSS}	Zero Gate Voltage Drain Current	$V_{GS} = 0V, V_{DS} = 600V$			40	μA
		$T_j = 25^\circ\text{C}$				
$R_{DS(on)}$	Drain – Source on Resistance	$V_{GS} = 0V, V_{DS} = 600V$			375	$\text{m}\Omega$
		$T_j = 125^\circ\text{C}$				
$V_{GS(th)}$	Gate Threshold Voltage	$V_{GS} = V_{DS}, I_D = 5.4\text{mA}$	2.1	3	3.9	V
I_{GSS}	Gate – Source Leakage Current	$V_{GS} = \pm 20\text{V}, V_{DS} = 0V$			± 150	nA

Dynamic Characteristics

Symbol	Characteristic	Test Conditions	Min	Typ	Max	Unit
C_{iss}	Input Capacitance	$V_{GS} = 0V$		14		nF
C_{oss}	Output Capacitance	$V_{DS} = 25V$		5.13		
C_{rss}	Reverse Transfer Capacitance	$f = 1\text{MHz}$		0.42		
Q_g	Total gate Charge	$V_{GS} = 10V$		518		nC
Q_{gs}	Gate – Source Charge	$V_{Bus} = 300V$		58		
Q_{gd}	Gate – Drain Charge	$I_D = 72A$		222		
$T_{d(on)}$	Turn-on Delay Time	Inductive Switching @ 125°C $V_{GS} = 15V$ $V_{Bus} = 400V$ $I_D = 72A$ $R_G = 2.5\Omega$		21		ns
T_r	Rise Time			30		
$T_{d(off)}$	Turn-off Delay Time			283		
T_f	Fall Time			84		
E_{on}	Turn-on Switching Energy	Inductive switching @ 25°C $V_{GS} = 15V, V_{Bus} = 400V$ $I_D = 72A, R_G = 2.5\Omega$		1340		μJ
E_{off}	Turn-off Switching Energy			1960		
E_{on}	Turn-on Switching Energy	Inductive switching @ 125°C $V_{GS} = 15V, V_{Bus} = 400V$ $I_D = 72A, R_G = 2.5\Omega$		2192		μJ
E_{off}	Turn-off Switching Energy			2412		

Chopper diode ratings and characteristics

Symbol	Characteristic	Test Conditions	Min	Typ	Max	Unit
V_{RRM}	Maximum Peak Repetitive Reverse Voltage		600			V
I_{RM}	Maximum Reverse Leakage Current	$V_R = 600V$	$T_j = 25^\circ\text{C}$		350	μA
			$T_j = 125^\circ\text{C}$		600	
I_F	DC Forward Current			80		A
V_F	Diode Forward Voltage	$I_F = 80A$ $V_{GE} = 0V$	$T_j = 25^\circ\text{C}$		1.45	V
			$T_j = 125^\circ\text{C}$		1.35	
t_{rr}	Reverse Recovery Time	$I_F = 80A$ $V_R = 300V$	$T_j = 25^\circ\text{C}$		95	ns
			$T_j = 125^\circ\text{C}$		115	
Q_{rr}	Reverse Recovery Charge	$di/dt = 4500A/\mu\text{s}$	$T_j = 25^\circ\text{C}$		5.2	μC
			$T_j = 125^\circ\text{C}$		8	

Thermal and package characteristics

Symbol Characteristic

		<i>Min</i>	<i>Typ</i>	<i>Max</i>	<i>Unit</i>	
R _{thJC}	Junction to Case Thermal Resistance	Transistor		0.3	°C/W	
		Diode		0.8		
V _{ISOL}	RMS Isolation Voltage, any terminal to case t=1 min, I _{isol} <1mA, 50/60Hz	2500			V	
T _J	Operating junction temperature range	-40		150	°C	
T _{STG}	Storage Temperature Range	-40		125		
T _C	Operating Case Temperature	-40		100		
Torque	Mounting torque	To heatsink	M4	2.5	4.7	N.m
Wt	Package Weight				110	g

Temperature sensor NTC (see application note APT0406 on www.microsemi.com for more information).

Symbol Characteristic

		<i>Min</i>	<i>Typ</i>	<i>Max</i>	<i>Unit</i>
R ₂₅	Resistance @ 25°C		50		kΩ
B _{25/85}	T ₂₅ = 298.15 K		3952		K

$$R_T = \frac{R_{25}}{\exp \left[B_{25/85} \left(\frac{1}{T_{25}} - \frac{1}{T} \right) \right]}$$

T: Thermistor temperature
 R_T: Thermistor value at T

SP3 Package outline (dimensions in mm)

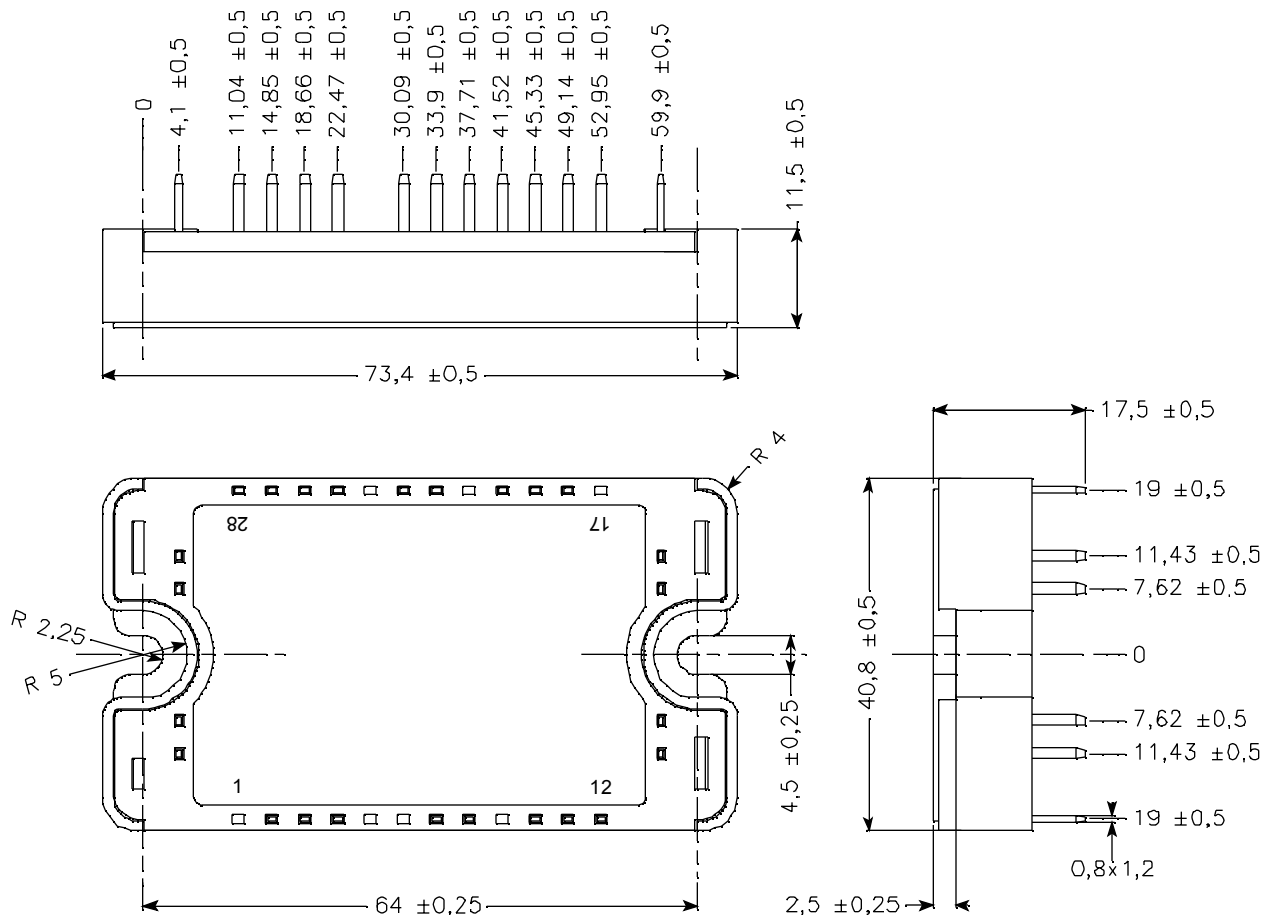

See application note 1901 - Mounting Instructions for SP3 Power Modules on www.microsemi.com

Typical Performance Curve

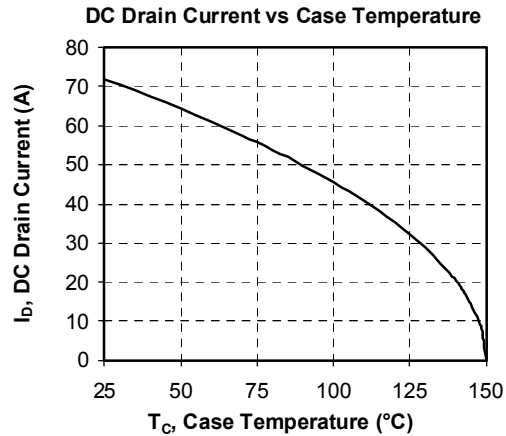
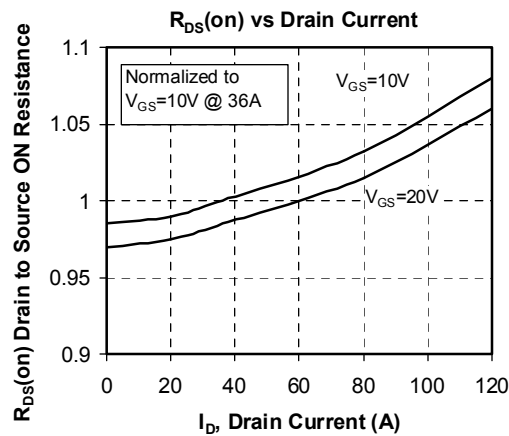
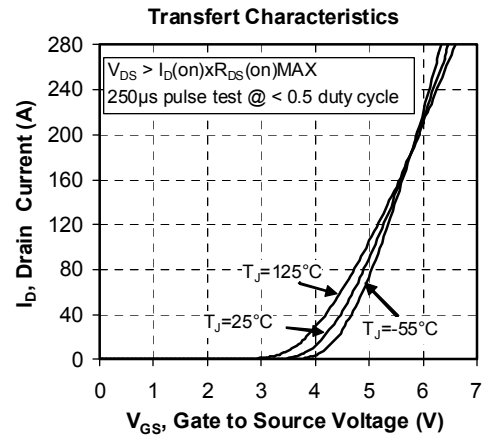
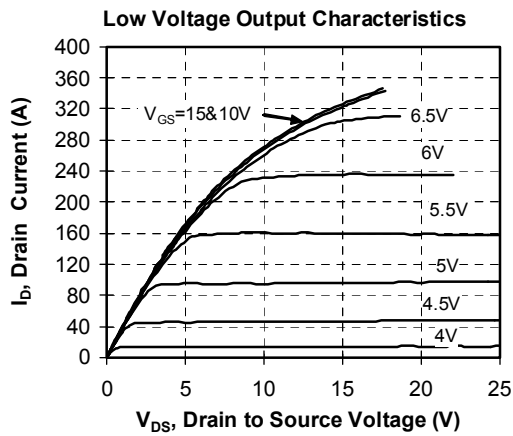
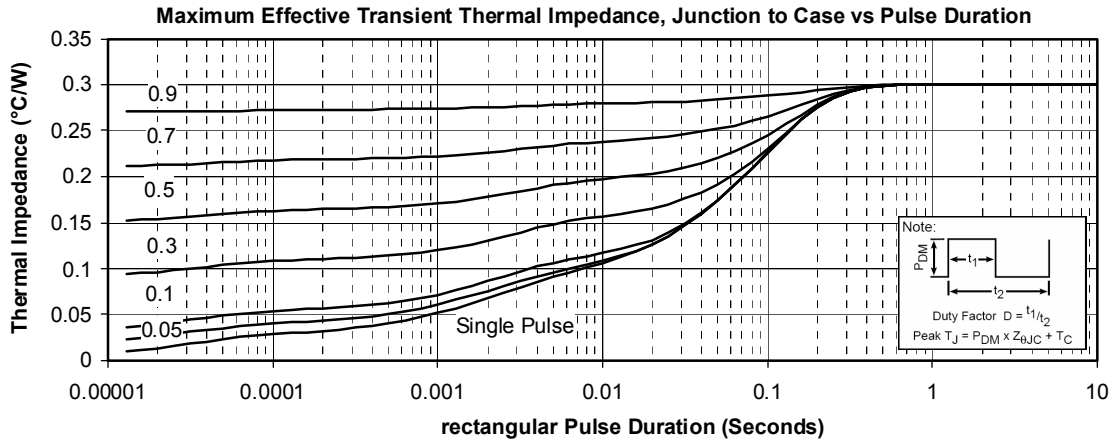

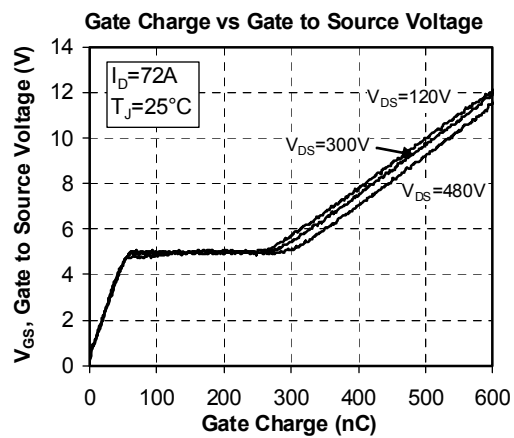
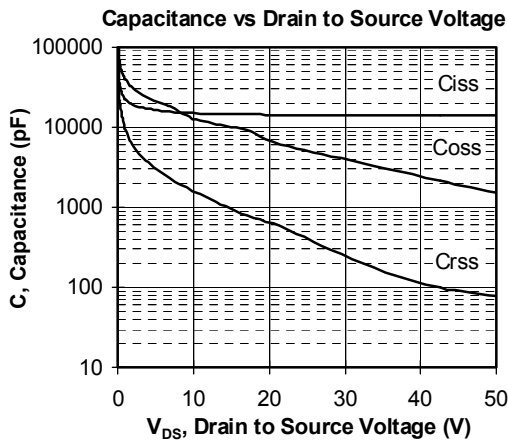
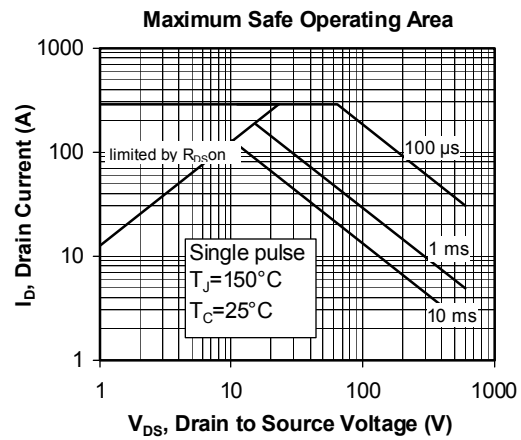
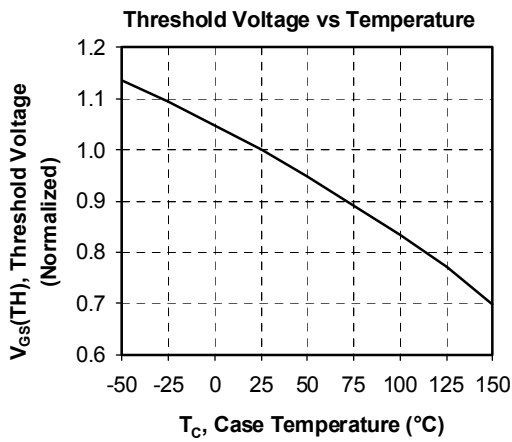
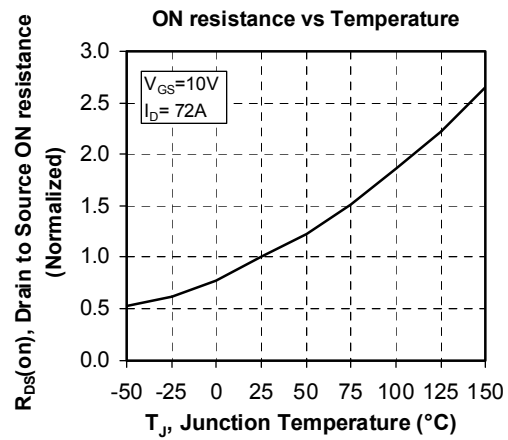

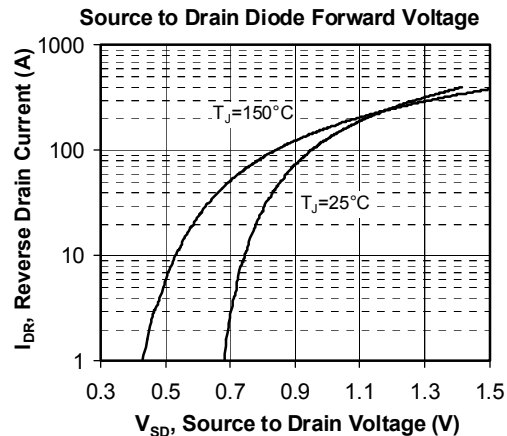
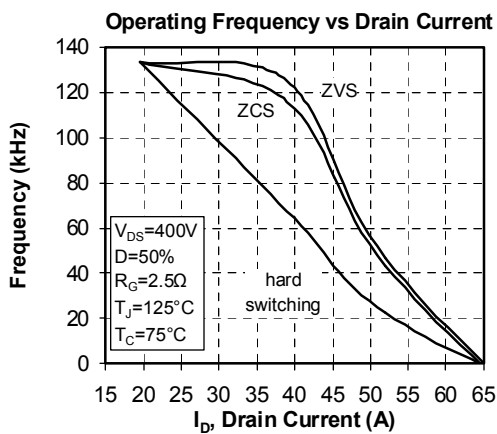
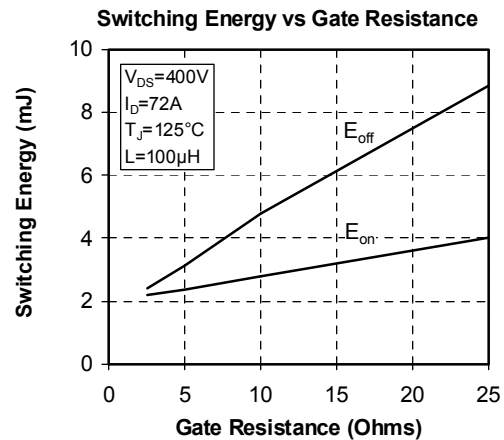
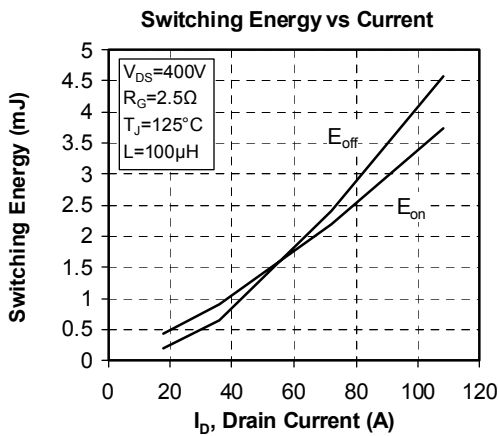
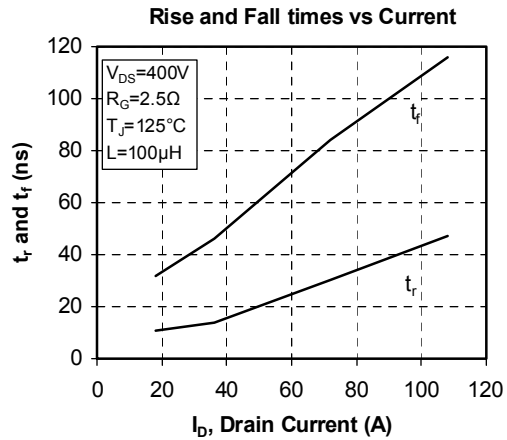
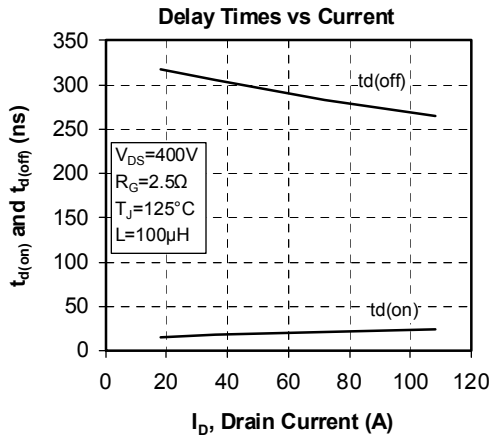

“COOLMOST™ comprise a new family of transistors developed by Infineon Technologies AG. “COOLMOS” is a trademark of Infineon Technologies AG”.

Microsemi reserves the right to change, without notice, the specifications and information contained herein

Microsemi's products are covered by one or more of U.S. patents 4,895,810 5,045,903 5,089,434 5,182,234 5,019,522 5,262,336 6,503,786 5,256,583 4,748,103 5,283,202 5,231,474 5,434,095 5,528,058 and foreign patents. U.S. and Foreign patents pending. All Rights Reserved.