

POWER MOS 7® FREDFET

Power MOS 7® is a new generation of low loss, high voltage, N-Channel enhancement mode power MOSFETS. Both conduction and switching losses are addressed with Power MOS 7® by significantly lowering $R_{DS(ON)}$ and Q_g . Power MOS 7® combines lower conduction and switching losses along with exceptionally fast switching speeds inherent with APT's patented metal gate structure.

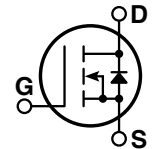

- Lower Input Capacitance
- Lower Miller Capacitance
- Lower Gate Charge, Q_g
- Increased Power Dissipation
- Easier To Drive
- Popular SOT-227 Package
- **FAST RECOVERY BODY DIODE**



MAXIMUM RATINGS

All Ratings: $T_C = 25^\circ\text{C}$ unless otherwise specified.

Symbol	Parameter	APT12057JFLL	UNIT
V_{DSS}	Drain-Source Voltage	1200	Volts
I_D	Continuous Drain Current @ $T_C = 25^\circ\text{C}$	19	Amps
I_{DM}	Pulsed Drain Current ^①	76	
V_{GS}	Gate-Source Voltage Continuous	± 30	Volts
V_{GSM}	Gate-Source Voltage Transient	± 40	
P_D	Total Power Dissipation @ $T_C = 25^\circ\text{C}$	520	Watts
	Linear Derating Factor	4.17	W/ $^\circ\text{C}$
T_J, T_{STG}	Operating and Storage Junction Temperature Range	-55 to 150	$^\circ\text{C}$
T_L	Lead Temperature: 0.063" from Case for 10 Sec.	300	
I_{AR}	Avalanche Current ^① (Repetitive and Non-Repetitive)	19	Amps
E_{AR}	Repetitive Avalanche Energy ^①	50	mJ
E_{AS}	Single Pulse Avalanche Energy ^④	3000	

STATIC ELECTRICAL CHARACTERISTICS

Symbol	Characteristic / Test Conditions	MIN	TYP	MAX	UNIT
BV_{DSS}	Drain-Source Breakdown Voltage ($V_{GS} = 0V, I_D = 250\mu\text{A}$)	1200			Volts
$R_{DS(on)}$	Drain-Source On-State Resistance ^② ($V_{GS} = 10V, 9.5A$)			0.570	Ohms
I_{DSS}	Zero Gate Voltage Drain Current ($V_{DS} = 1200V, V_{GS} = 0V$)			250	μA
	Zero Gate Voltage Drain Current ($V_{DS} = 960V, V_{GS} = 0V, T_C = 125^\circ\text{C}$)			1000	
I_{GSS}	Gate-Source Leakage Current ($V_{GS} = \pm 30V, V_{DS} = 0V$)			± 100	nA
$V_{GS(th)}$	Gate Threshold Voltage ($V_{DS} = V_{GS}, I_D = 2.5mA$)	3		5	Volts

 **CAUTION:** These Devices are Sensitive to Electrostatic Discharge. Proper Handling Procedures Should Be Followed.

APT Website - <http://www.advancedpower.com>

DYNAMIC CHARACTERISTICS

APT12057JFLL

Symbol	Characteristic	Test Conditions	MIN	TYP	MAX	UNIT
C_{iss}	Input Capacitance	$V_{GS} = 0V$ $V_{DS} = 25V$ $f = 1\text{ MHz}$		5155		pF
C_{oss}	Output Capacitance			770		
C_{rss}	Reverse Transfer Capacitance			130		
Q_g	Total Gate Charge ③	$V_{GS} = 10V$ $V_{DD} = 600V$ $I_D = 19A @ 25^\circ C$		185		nC
Q_{gs}	Gate-Source Charge			24		
Q_{gd}	Gate-Drain ("Miller") Charge			120		
$t_{d(on)}$	Turn-on Delay Time	RESISTIVE SWITCHING $V_{GS} = 15V$ $V_{DD} = 600V$ $I_D = 19A @ 25^\circ C$ $R_G = 0.6\Omega$		11		ns
t_r	Rise Time			18		
$t_{d(off)}$	Turn-off Delay Time			36		
t_f	Fall Time			24		
E_{on}	Turn-on Switching Energy ⑥	INDUCTIVE SWITCHING @ 25°C $V_{DD} = 800V, V_{GS} = 15V$ $I_D = 19A, R_G = 5\Omega$		725		μJ
E_{off}	Turn-off Switching Energy			365		
E_{on}	Turn-on Switching Energy ⑥	INDUCTIVE SWITCHING @ 125°C $V_{DD} = 800V, V_{GS} = 15V$ $I_D = 19A, R_G = 5\Omega$		1200		
E_{off}	Turn-off Switching Energy			450		

SOURCE-DRAIN DIODE RATINGS AND CHARACTERISTICS

Symbol	Characteristic / Test Conditions	MIN	TYP	MAX	UNIT
I_S	Continuous Source Current (Body Diode)			19	Amps
I_{SM}	Pulsed Source Current ① (Body Diode)			76	Amps
V_{SD}	Diode Forward Voltage ② ($V_{GS} = 0V, I_S = -19A$)			1.3	Volts
dv/dt	Peak Diode Recovery dv/dt ⑤			18	V/ns
t_{rr}	Reverse Recovery Time ($I_S = -19A, di/dt = 100A/\mu s$)	$T_j = 25^\circ C$		320	ns
		$T_j = 125^\circ C$		650	
Q_{rr}	Reverse Recovery Charge ($I_S = -19A, di/dt = 100A/\mu s$)	$T_j = 25^\circ C$		2.0	μC
		$T_j = 125^\circ C$		7.0	
I_{RRM}	Peak Recovery Current ($I_S = -19A, di/dt = 100A/\mu s$)	$T_j = 25^\circ C$		13	Amps
		$T_j = 125^\circ C$		22	

THERMAL CHARACTERISTICS

Symbol	Characteristic	MIN	TYP	MAX	UNIT
$R_{\theta JC}$	Junction to Case			0.24	$^\circ C/W$
$R_{\theta JA}$	Junction to Ambient			40	

① Repetitive Rating: Pulse width limited by maximum junction temperature

② Pulse Test: Pulse width < 380 μs , Duty Cycle < 2%

③ See MIL-STD-750 Method 3471

④ Starting $T_j = +25^\circ C$, $L = 16.62mH$, $R_G = 25\Omega$, Peak $I_L = 19A$

⑤ dv/dt numbers reflect the limitations of the test circuit rather than the device itself. $I_S \leq -19A$, $di/dt \leq 700A/\mu s$, $V_R \leq 1200$, $T_j \leq 150^\circ C$

⑥ E_{on} includes diode reverse recovery. See figures 18, 20.

APT Reserves the right to change, without notice, the specifications and information contained herein.

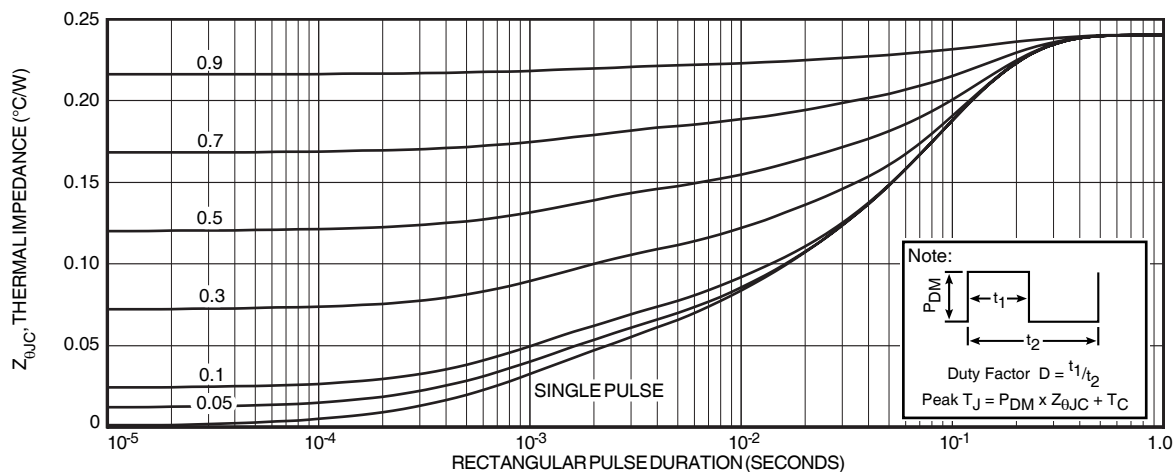

FIGURE 1, MAXIMUM EFFECTIVE TRANSIENT THERMAL IMPEDANCE, JUNCTION-TO-CASE vs PULSE DURATION

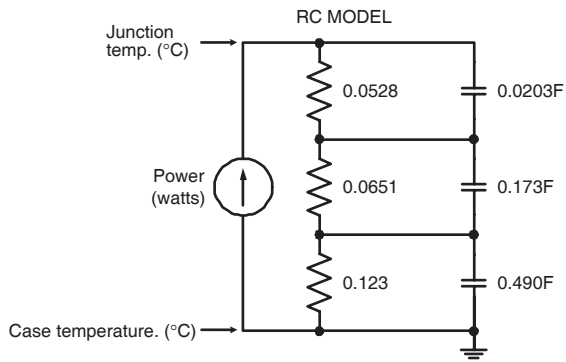

FIGURE 2, TRANSIENT THERMAL IMPEDANCE MODEL

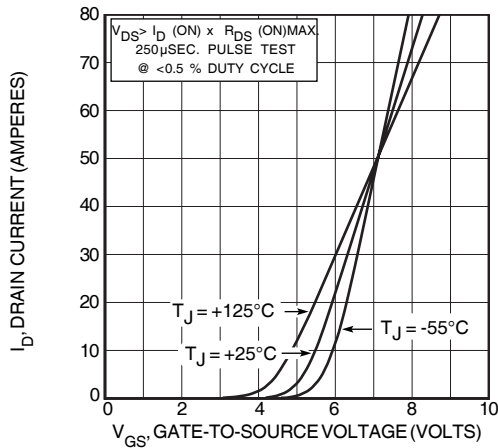

FIGURE 4, TRANSFER CHARACTERISTICS

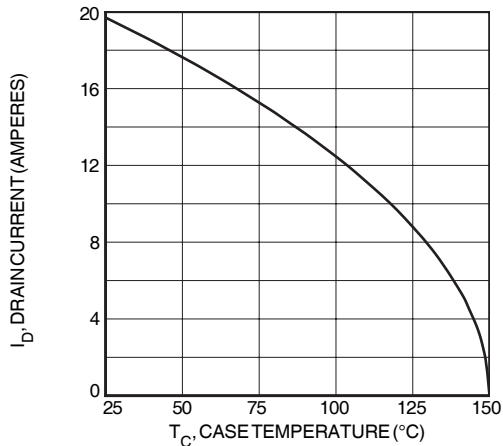

FIGURE 6, MAXIMUM DRAIN CURRENT vs CASE TEMPERATURE

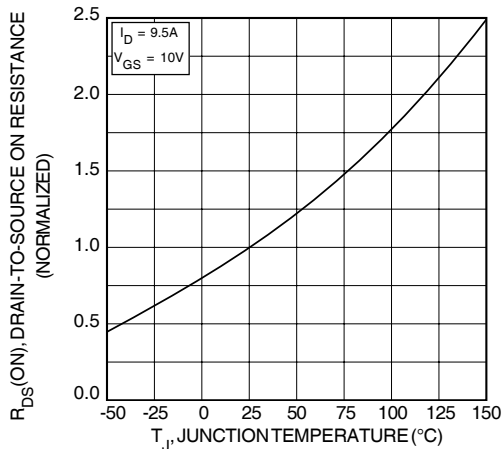

FIGURE 8, ON-RESISTANCE vs. TEMPERATURE

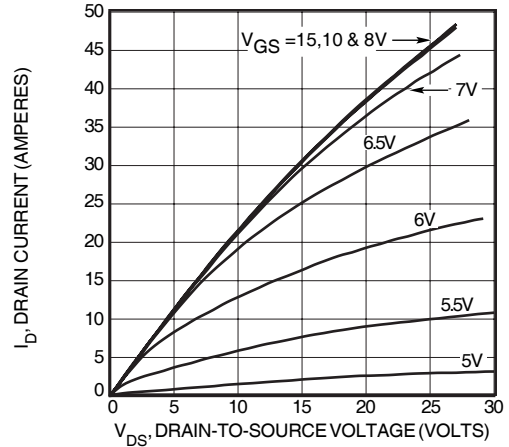

FIGURE 3, LOW VOLTAGE OUTPUT CHARACTERISTICS

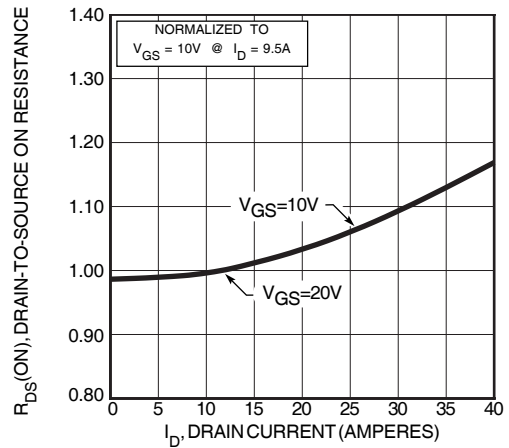

FIGURE 5, $R_{DS}(ON)$ vs DRAIN CURRENT

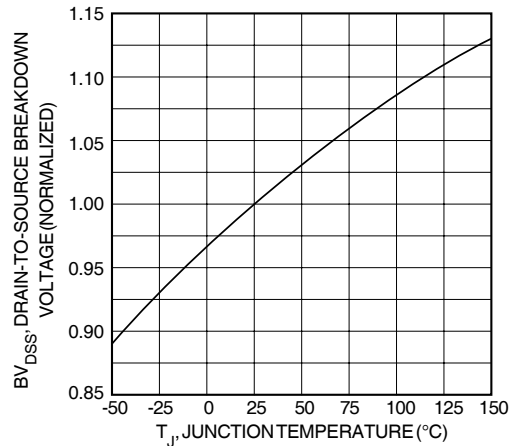

FIGURE 7, BREAKDOWN VOLTAGE vs TEMPERATURE

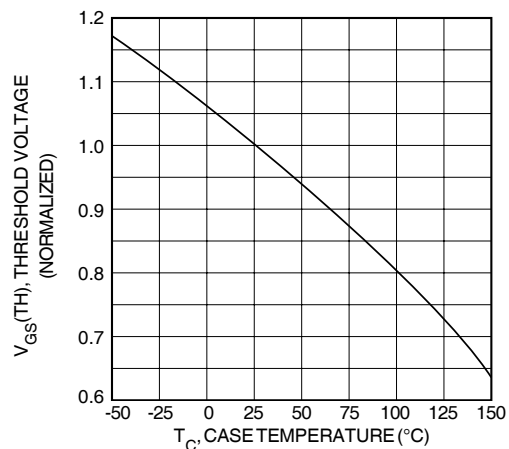

FIGURE 9, THRESHOLD VOLTAGE vs TEMPERATURE

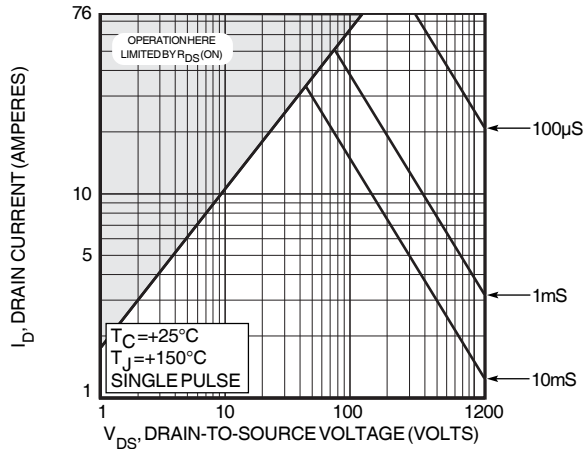

FIGURE 10, MAXIMUM SAFE OPERATING AREA

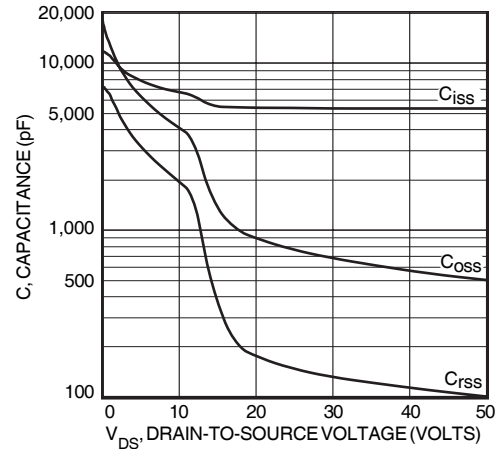

FIGURE 11, CAPACITANCE vs DRAIN-TO-SOURCE VOLTAGE

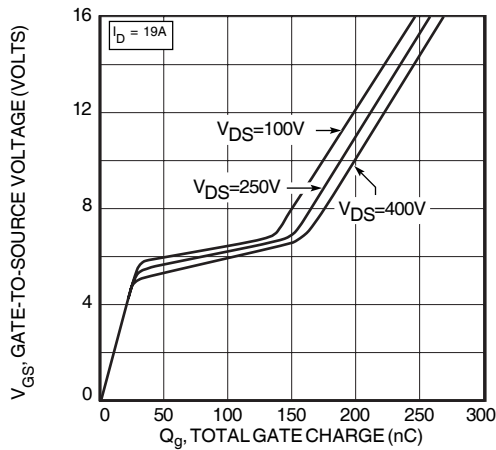

FIGURE 12, GATE CHARGES vs GATE-TO-SOURCE VOLTAGE

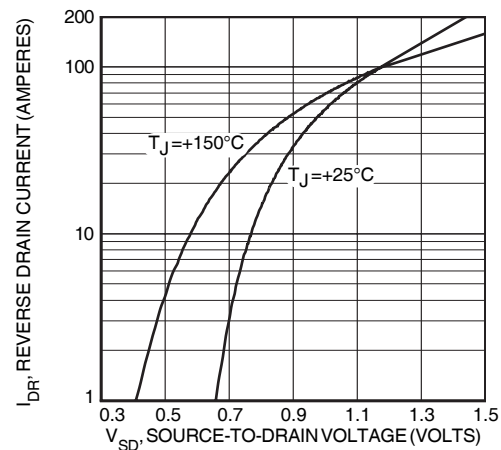

FIGURE 13, SOURCE-DRAIN DIODE FORWARD VOLTAGE

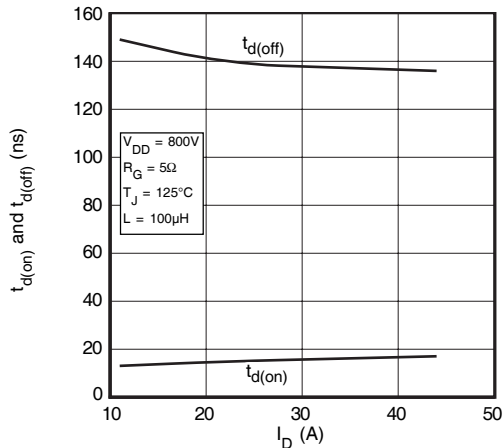

FIGURE 14, DELAY TIMES vs CURRENT

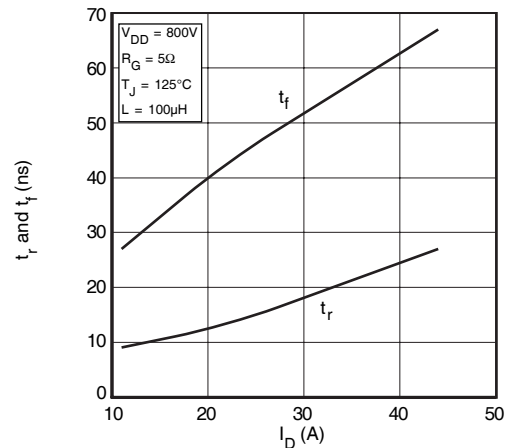

FIGURE 15, RISE AND FALL TIMES vs CURRENT

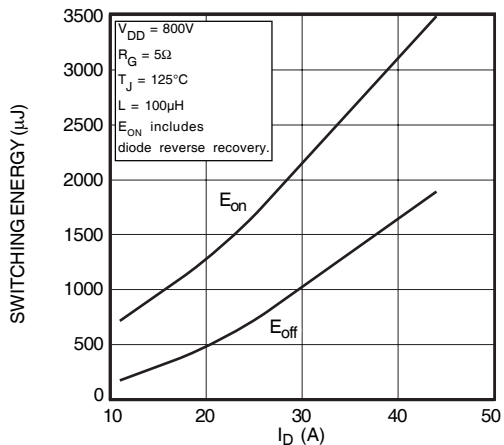

FIGURE 16, SWITCHING ENERGY vs CURRENT

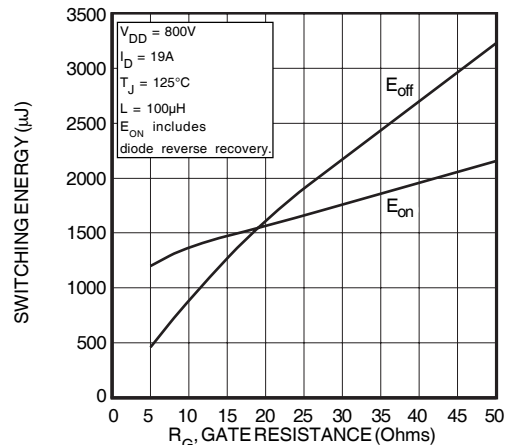

FIGURE 17, SWITCHING ENERGY vs. GATE RESISTANCE

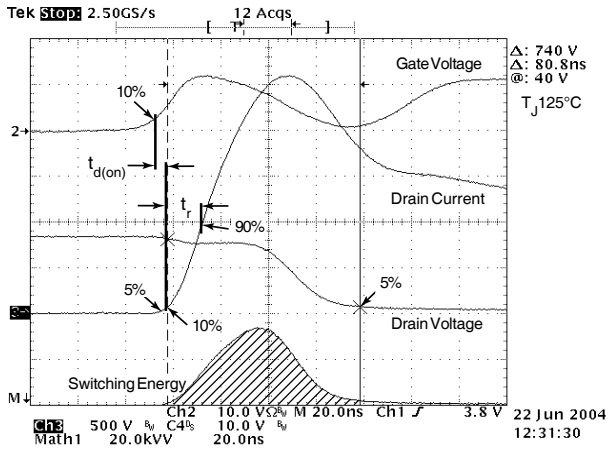

Figure 18, Turn-on Switching Waveforms and Definitions

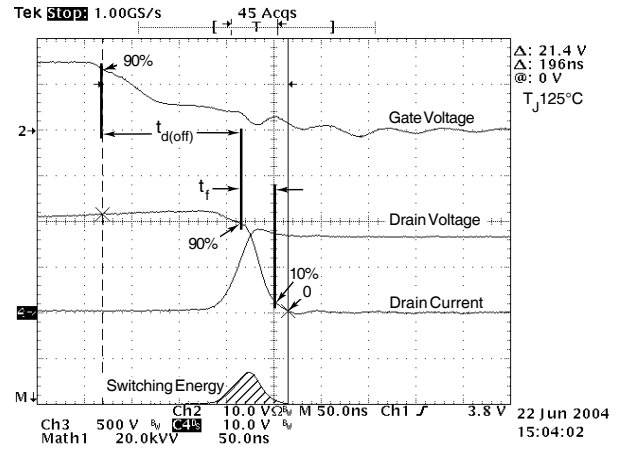

Figure 19, Turn-off Switching Waveforms and Definitions

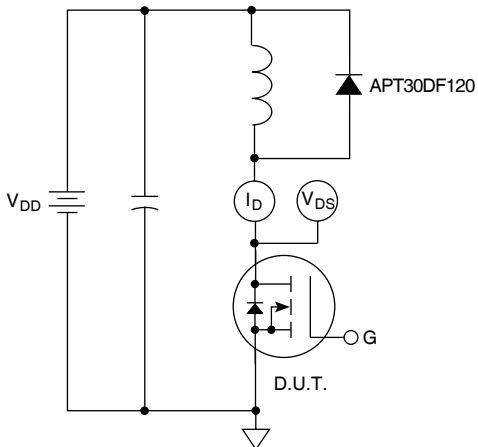
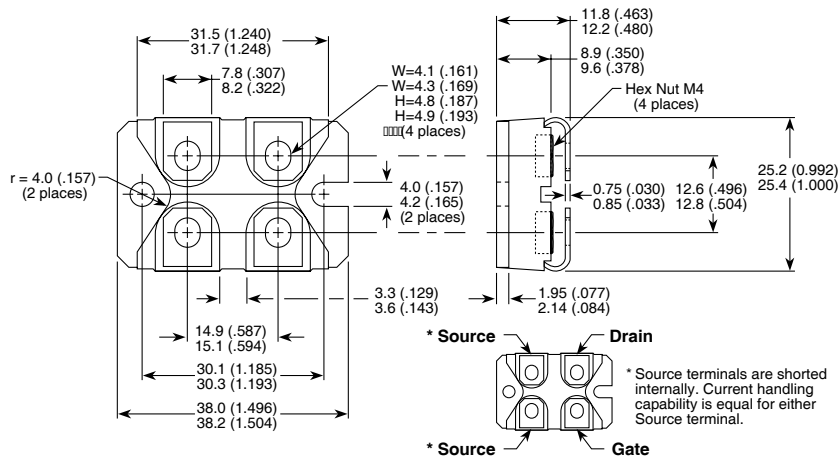

Figure 20, Inductive Switching Test Circuit

SOT-227 (ISOTOP®) Package Outline



Dimensions in Millimeters and (Inches)

ISOTOP® is a Registered Trademark of SGS-Thomson. APT's products are covered by one or more of U.S. patents 4,895,810 5,045,903 5,089,434 5,182,234 5,019,522 5,262,336 6,503,786 5,256,583 4,748,103 5,283,202 5,231,474 5,434,095 5,528,058 and foreign patents. US and Foreign patents pending. All Rights Reserved.