

Dual Buck chopper NPT IGBT Power Module

$V_{CES} = 1200V$
 $I_C = 25A @ T_c = 80^\circ C$

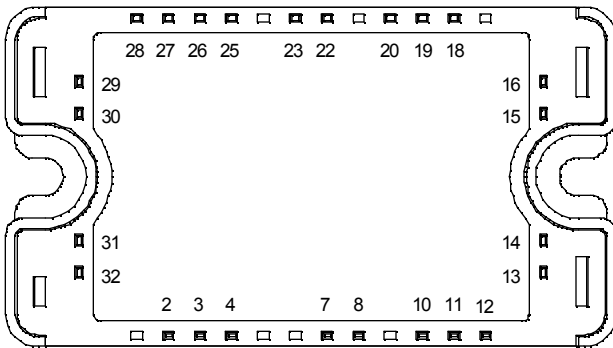
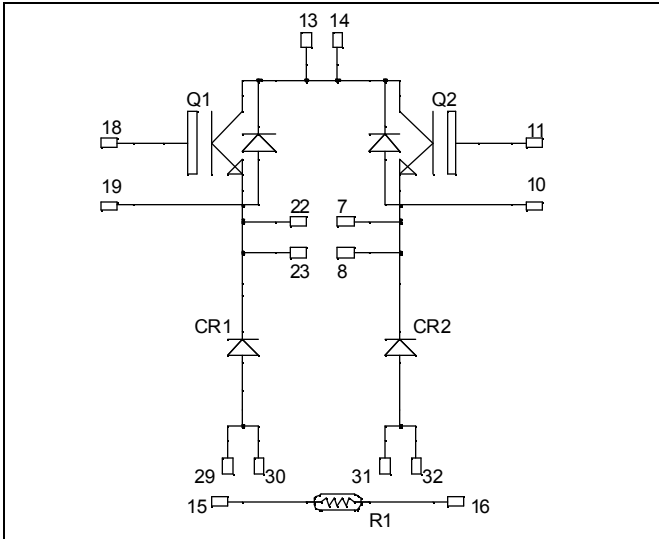

All multiple inputs and outputs must be shorted together
 Example: 13/14 ; 29/30 ; 22/23 ...

Application

- AC and DC motor control
- Switched Mode Power Supplies

Features

- Non Punch Through (NPT) Fast IGBT®
 - Low voltage drop
 - Low tail current
 - Switching frequency up to 50 kHz
 - Soft recovery parallel diodes
 - Low diode VF
 - Low leakage current
 - Avalanche energy rated
 - RBSOA and SCSOA rated
 - Symmetrical design
- Kelvin emitter for easy drive
- Very low stray inductance
- High level of integration
- Internal thermistor for temperature monitoring

Benefits

- Outstanding performance at high frequency operation
- Direct mounting to heatsink (isolated package)
- Low junction to case thermal resistance
- Solderable terminals both for power and signal for easy PCB mounting
- Low profile
- Easy paralleling due to positive TC of VCEsat
- Each leg can be easily paralleled to achieve a single buck of twice the current capability.
- RoHS compliant

Absolute maximum ratings

Symbol	Parameter	Max ratings	Unit
V_{CES}	Collector - Emitter Breakdown Voltage	1200	V
I_C	Continuous Collector Current	$T_c = 25^\circ C$	40
		$T_c = 80^\circ C$	25
I_{CM}	Pulsed Collector Current	$T_c = 25^\circ C$	100
V_{GE}	Gate - Emitter Voltage	± 20	V
P_D	Maximum Power Dissipation	$T_c = 25^\circ C$	208
RBSOA	Reverse Bias Safe Operating Area	$T_j = 125^\circ C$	50A@1150V

CAUTION: These Devices are sensitive to Electrostatic Discharge. Proper Handling Procedures Should Be Followed. See application note APT0502 on www.microsemi.com

All ratings @ $T_j = 25^\circ\text{C}$ unless otherwise specified

Electrical Characteristics

Symbol	Characteristic	Test Conditions	Min	Typ	Max	Unit	
I_{CES}	Zero Gate Voltage Collector Current	$V_{GE} = 0\text{V}$ $V_{CE} = 1200\text{V}$	$T_j = 25^\circ\text{C}$			250	μA
			$T_j = 125^\circ\text{C}$			500	
$V_{CE(sat)}$	Collector Emitter saturation Voltage	$V_{GE} = 15\text{V}$ $I_C = 25\text{A}$	$T_j = 25^\circ\text{C}$	2.5	3.2	3.7	V
			$T_j = 125^\circ\text{C}$		4.0		
$V_{GE(th)}$	Gate Threshold Voltage	$V_{GE} = V_{CE}, I_C = 1\text{mA}$	4		6	V	
I_{GES}	Gate – Emitter Leakage Current	$V_{GE} = 20\text{V}, V_{CE} = 0\text{V}$			400	nA	

Dynamic Characteristics

Symbol	Characteristic	Test Conditions	Min	Typ	Max	Unit
C_{ies}	Input Capacitance	$V_{GE} = 0\text{V}$ $V_{CE} = 25\text{V}$ $f = 1\text{MHz}$		1650		pF
C_{oes}	Output Capacitance			250		
C_{res}	Reverse Transfer Capacitance			110		
Q_g	Total gate Charge	$V_{GE} = 15\text{V}$ $V_{Bus} = 300\text{V}$ $I_C = 25\text{A}$		160		nC
Q_{ge}	Gate – Emitter Charge			10		
Q_{gc}	Gate – Collector Charge			70		
$T_{d(on)}$	Turn-on Delay Time	Inductive Switching (25°C) $V_{GE} = 15\text{V}$ $V_{Bus} = 400\text{V}$ $I_C = 25\text{A}$ $R_G = 22\Omega$		60		ns
T_r	Rise Time			50		
$T_{d(off)}$	Turn-off Delay Time			305		
T_f	Fall Time			30		
$T_{d(on)}$	Turn-on Delay Time	Inductive Switching (125°C) $V_{GE} = 15\text{V}$ $V_{Bus} = 400\text{V}$ $I_C = 25\text{A}$ $R_G = 22\Omega$		60		ns
T_r	Rise Time			50		
$T_{d(off)}$	Turn-off Delay Time			346		
T_f	Fall Time			40		
E_{on}	Turn-on Switching Energy	$V_{GE} = 15\text{V}$ $V_{Bus} = 400\text{V}$ $I_C = 25\text{A}$ $R_G = 22\Omega$	$T_j = 125^\circ\text{C}$	3.5		mJ
E_{off}	Turn-off Switching Energy		$T_j = 125^\circ\text{C}$	1.5		

Chopper diode ratings and characteristics

Symbol	Characteristic	Test Conditions	Min	Typ	Max	Unit	
V_{RRM}	Maximum Peak Repetitive Reverse Voltage		1200			V	
I_{RM}	Maximum Reverse Leakage Current	$V_R = 1200\text{V}$	$T_j = 25^\circ\text{C}$			250	μA
			$T_j = 125^\circ\text{C}$			500	
I_F	Forward Current			60		A	
V_F	Diode Forward Voltage	$I_F = 60\text{A}$		2	2.5	V	
		$I_F = 120\text{A}$		2.3			
		$I_F = 60\text{A}$	$T_j = 125^\circ\text{C}$	1.8			
t_{rr}	Reverse Recovery Time	$I_F = 60\text{A}$ $V_R = 800\text{V}$ $di/dt = 200\text{A}/\mu\text{s}$	$T_j = 25^\circ\text{C}$	400		ns	
			$T_j = 125^\circ\text{C}$	470			
Q_{rr}	Reverse Recovery Charge		$T_j = 25^\circ\text{C}$	1.2		μC	
			$T_j = 125^\circ\text{C}$	4			

Temperature sensor NTC (see application note APT0406 on www.microsemi.com for more information).

Symbol	Characteristic	Min	Typ	Max	Unit
R ₂₅	Resistance @ 25°C		50		kΩ
B _{25/85}	T ₂₅ = 298.15 K		3952		K

$$R_T = \frac{R_{25}}{\exp \left[B_{25/85} \left(\frac{1}{T_{25}} - \frac{1}{T} \right) \right]}$$

T: Thermistor temperature
 R_T: Thermistor value at T

Thermal and package characteristics

Symbol	Characteristic	Min	Typ	Max	Unit		
R _{thJC}	Junction to Case Thermal Resistance	IGBT		0.6	°C/W		
		Diode		0.9			
V _{ISOL}	RMS Isolation Voltage, any terminal to case t=1 min, I _{isol} <1mA, 50/60Hz	2500			V		
T _J	Operating junction temperature range	-40		150	°C		
T _{STG}	Storage Temperature Range	-40		125			
T _C	Operating Case Temperature	-40		100			
Torque	Mounting torque		To heatsink	M4	2.5	4.7	N.m
Wt	Package Weight					110	g

SP3 Package outline (dimensions in mm)

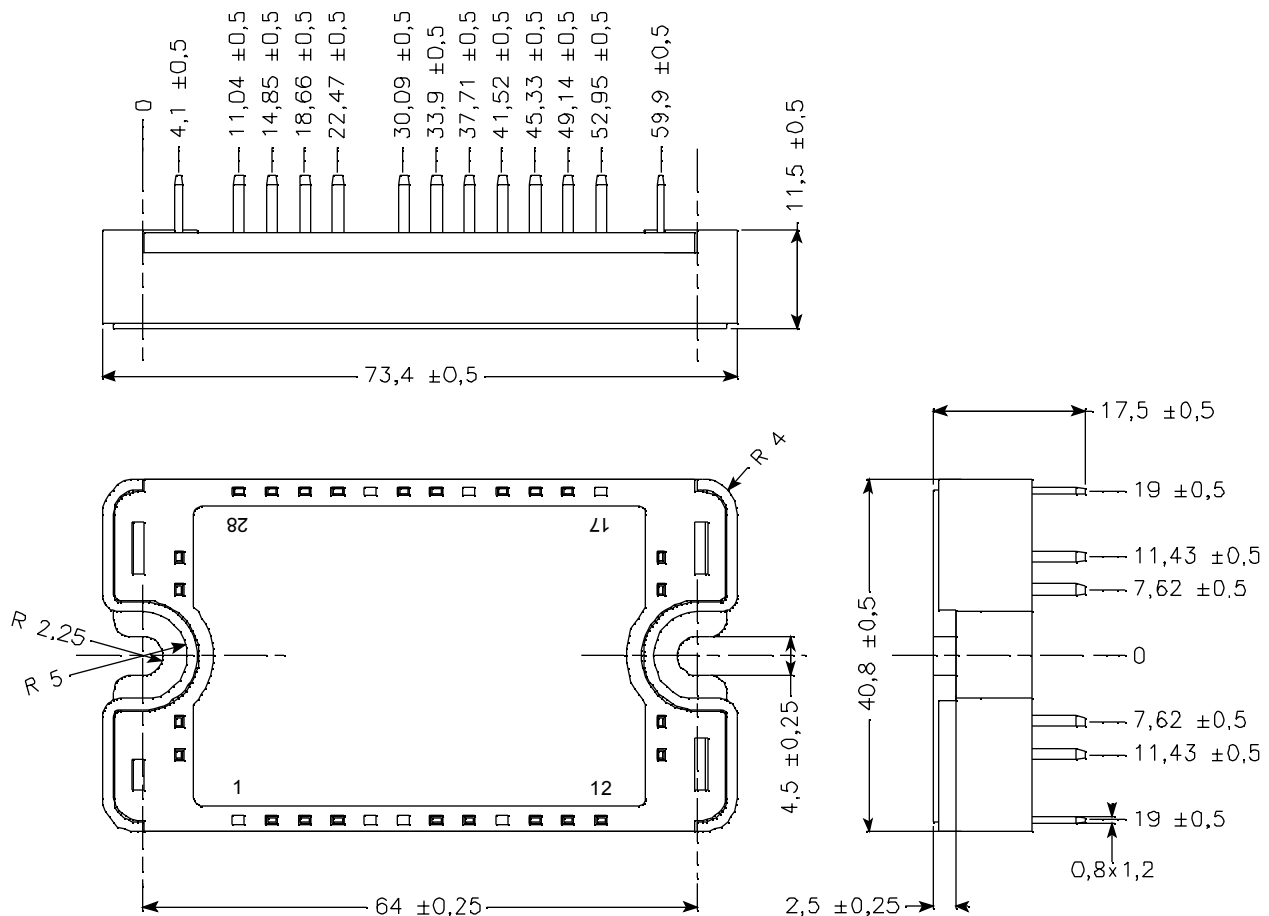

See application note 1901 - Mounting Instructions for SP3 Power Modules on www.microsemi.com

Typical Performance Curve

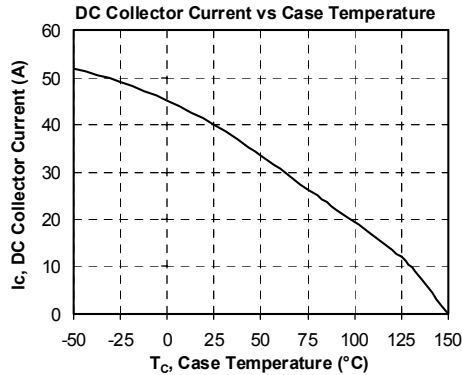
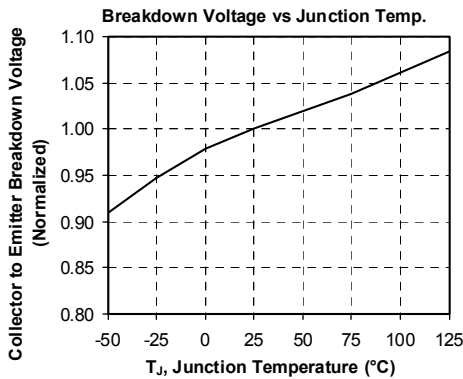
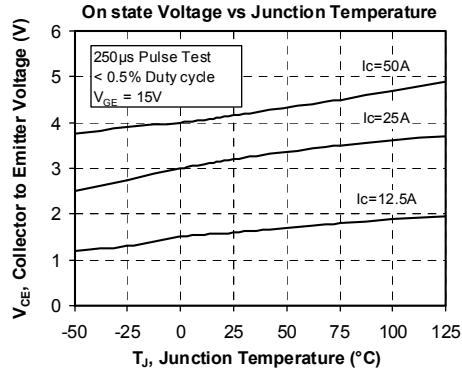
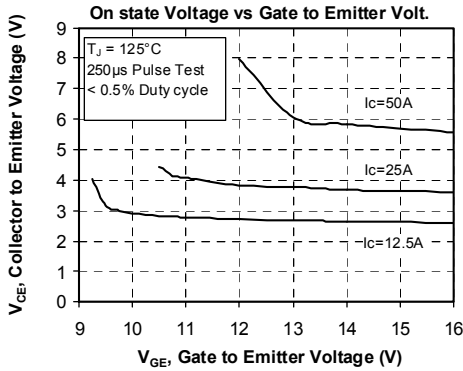
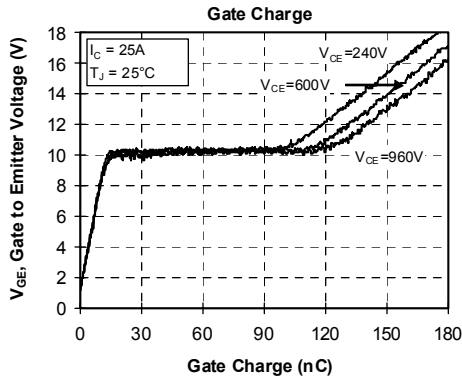
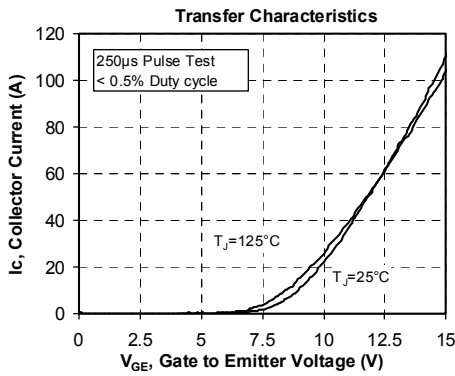
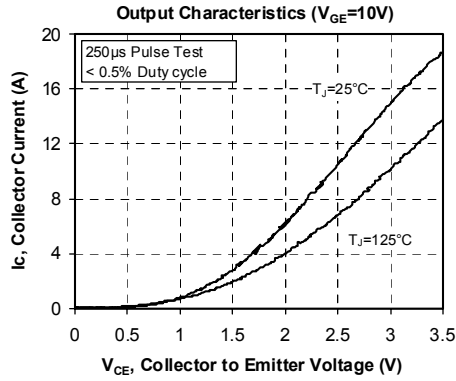
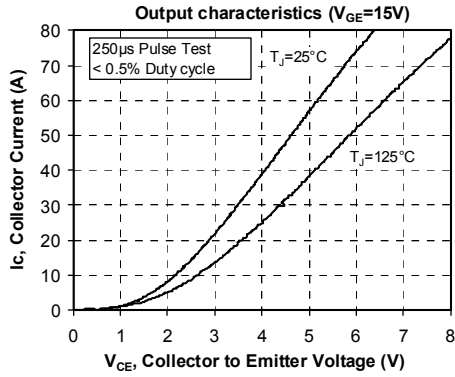

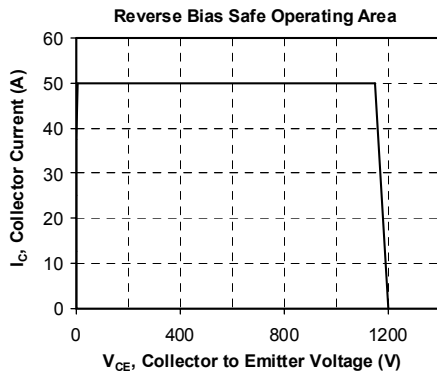
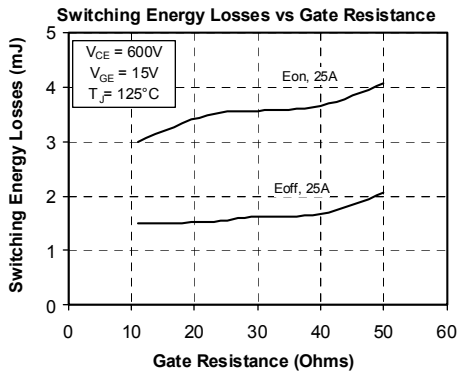
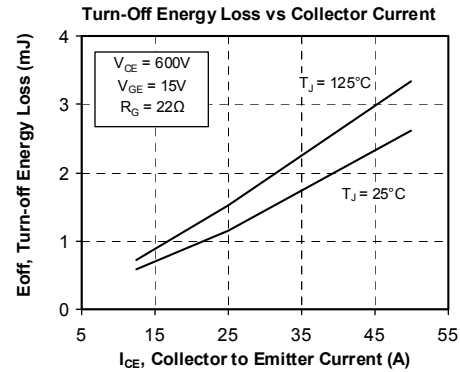
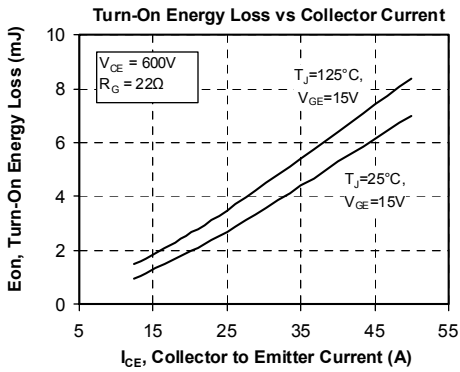
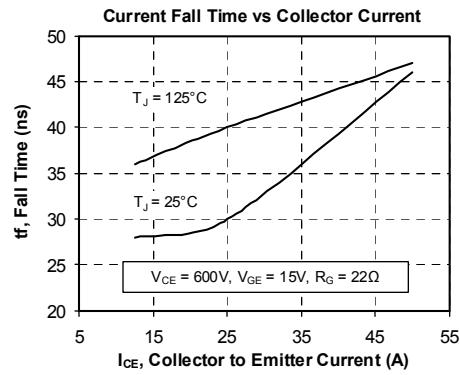
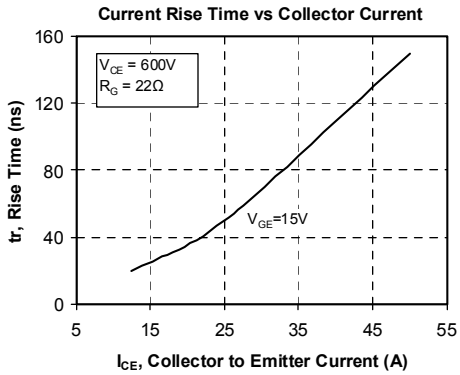
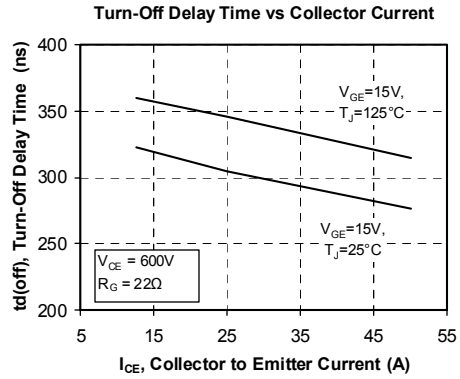
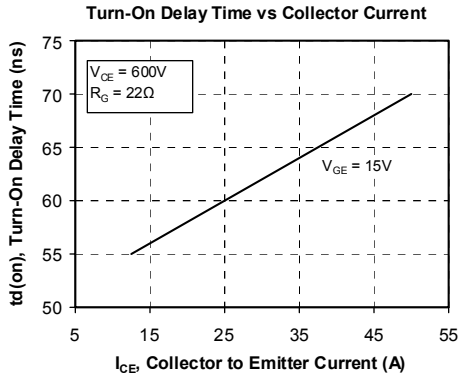

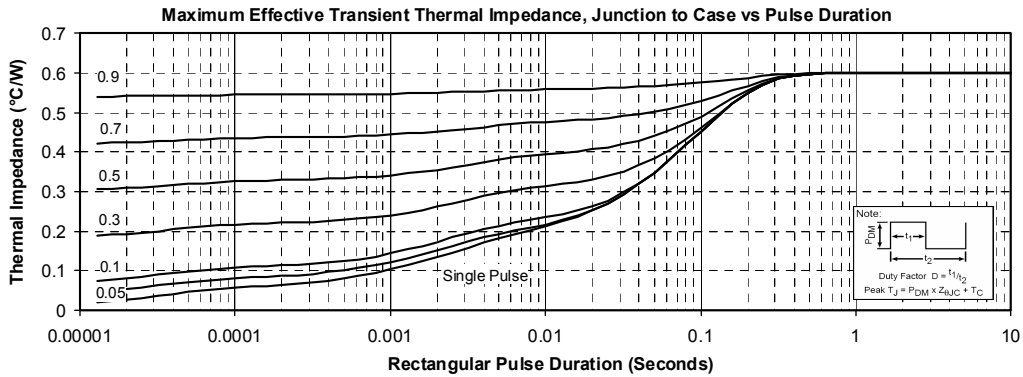
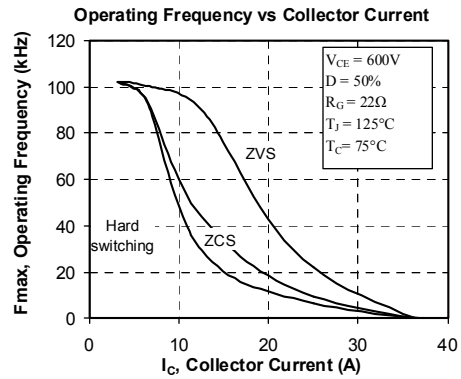
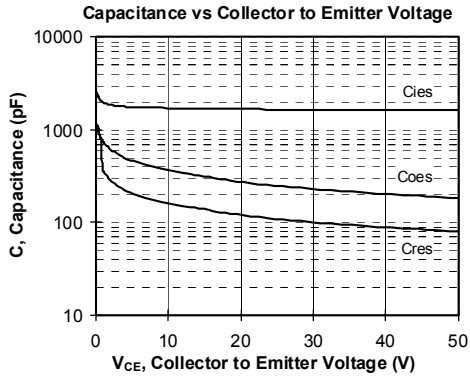

Microsemi reserves the right to change, without notice, the specifications and information contained herein

Microsemi's products are covered by one or more of U.S. patents 4,895,810 5,045,903 5,089,434 5,182,234 5,019,522 5,262,336 6,503,786 5,256,583 4,748,103 5,283,202 5,231,474 5,434,095 5,528,058 and foreign patents. U.S. and Foreign patents pending. All Rights Reserved.