

## Full - Bridge NPT IGBT Power Module

$V_{CES} = 1200V$   
 $I_C = 15A @ T_c = 80^\circ C$

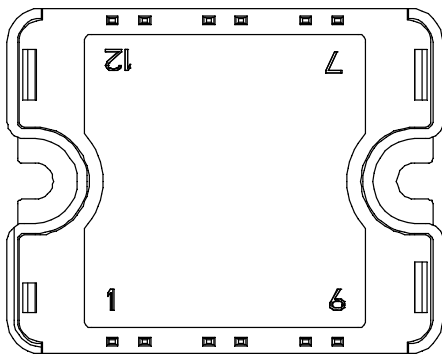
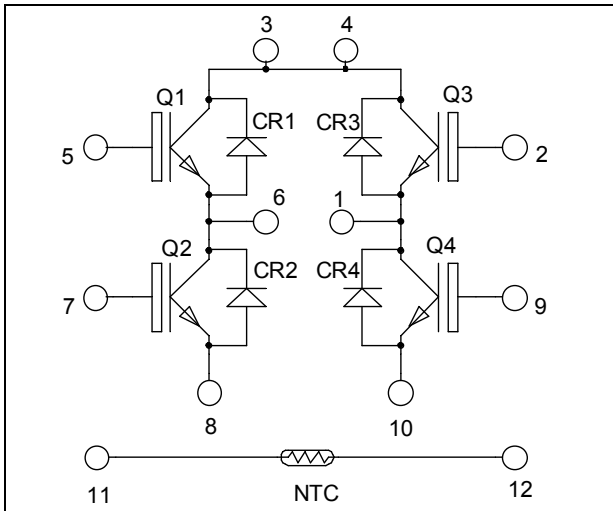

Pins 3/4 must be shorted together

### Application

- Welding converters
- Switched Mode Power Supplies
- Uninterruptible Power Supplies
- Motor control

### Features

- Non Punch Through (NPT) Fast IGBT
  - Low voltage drop
  - Low tail current
  - Switching frequency up to 50 kHz
  - Soft recovery parallel diodes
  - Low diode VF
  - Low leakage current
  - RBSOA and SCSOA rated
- Very low stray inductance
  - Symmetrical design
- Internal thermistor for temperature monitoring
- High level of integration

### Benefits

- Outstanding performance at high frequency operation
- Direct mounting to heatsink (isolated package)
- Low junction to case thermal resistance
- Solderable terminals both for power and signal for easy PCB mounting
- Low profile
- Each leg can be easily paralleled to achieve a phase leg of twice the current capability
- RoHS Compliant

### Absolute maximum ratings

Symbol	Parameter	Max ratings	Unit
$V_{CES}$	Collector - Emitter Breakdown Voltage	1200	V
$I_C$	Continuous Collector Current	$T_C = 25^\circ C$	25
		$T_C = 80^\circ C$	15
$I_{CM}$	Pulsed Collector Current	$T_C = 25^\circ C$	60
$V_{GE}$	Gate - Emitter Voltage	$\pm 20$	V
$P_D$	Maximum Power Dissipation	$T_C = 25^\circ C$	140
RBSOA	Reverse Bias Safe Operating Area	$T_j = 125^\circ C$	30A@1150V

**CAUTION:** These Devices are sensitive to Electrostatic Discharge. Proper Handling Procedures Should Be Followed. See application note APT0502 on [www.microsemi.com](http://www.microsemi.com)

All ratings @  $T_j = 25^\circ\text{C}$  unless otherwise specified

**Electrical Characteristics**

Symbol	Characteristic	Test Conditions	Min	Typ	Max	Unit	
$I_{CES}$	Zero Gate Voltage Collector Current	$V_{GE} = 0\text{V}$ $V_{CE} = 1200\text{V}$	$T_j = 25^\circ\text{C}$		250	$\mu\text{A}$	
			$T_j = 125^\circ\text{C}$		500		
$V_{CE(sat)}$	Collector Emitter Saturation Voltage	$V_{GE} = 15\text{V}$ $I_C = 15\text{A}$	$T_j = 25^\circ\text{C}$	2.5	3.2	3.7	V
			$T_j = 125^\circ\text{C}$		4.0		
$V_{GE(th)}$	Gate Threshold Voltage	$V_{GE} = V_{CE}, I_C = 1\text{mA}$	4		6	V	
$I_{GES}$	Gate – Emitter Leakage Current	$V_{GE} = 20\text{V}, V_{CE} = 0\text{V}$			400	nA	

**Dynamic Characteristics**

Symbol	Characteristic	Test Conditions	Min	Typ	Max	Unit
$C_{ies}$	Input Capacitance	$V_{GE} = 0\text{V}$ $V_{CE} = 25\text{V}$ $f = 1\text{MHz}$		1000		pF
$C_{oes}$	Output Capacitance			150		
$C_{res}$	Reverse Transfer Capacitance			70		
$Q_g$	Total gate Charge	$V_{GE} = 15\text{V}$ $V_{Bus} = 600\text{V}$ $I_C = 15\text{A}$		99		nC
$Q_{ge}$	Gate – Emitter Charge			10		
$Q_{gc}$	Gate – Collector Charge			70		
$T_{d(on)}$	Turn-on Delay Time	Inductive Switching ( $25^\circ\text{C}$ ) $V_{GE} = 15\text{V}$ $V_{Bus} = 600\text{V}$ $I_C = 15\text{A}$ $R_G = 33\Omega$		60		ns
$T_r$	Rise Time			50		
$T_{d(off)}$	Turn-off Delay Time			315		
$T_f$	Fall Time			30		
$T_{d(on)}$	Turn-on Delay Time	Inductive Switching ( $125^\circ\text{C}$ ) $V_{GE} = 15\text{V}$ $V_{Bus} = 600\text{V}$ $I_C = 15\text{A}$ $R_G = 33\Omega$		60		ns
$T_r$	Rise Time			50		
$T_{d(off)}$	Turn-off Delay Time			356		
$T_f$	Fall Time			40		
$E_{on}$	Turn-on Switching Energy	$V_{GE} = 15\text{V}$ $V_{Bus} = 600\text{V}$ $I_C = 15\text{A}$ $R_G = 33\Omega$	$T_j = 125^\circ\text{C}$	2		mJ
$E_{off}$	Turn-off Switching Energy		$T_j = 125^\circ\text{C}$	1		

**Reverse diode ratings and characteristics**

Symbol	Characteristic	Test Conditions	Min	Typ	Max	Unit
$V_{RRM}$	Maximum Peak Repetitive Reverse Voltage		1200			V
$I_{RM}$	Maximum Reverse Leakage Current	$V_R = 1200\text{V}$	$T_j = 25^\circ\text{C}$		100	$\mu\text{A}$
			$T_j = 125^\circ\text{C}$		500	
$I_F$	DC Forward Current			15		A
$V_F$	Diode Forward Voltage	$I_F = 15\text{A}$		2.8	3.3	V
		$I_F = 30\text{A}$		3.4		
		$I_F = 15\text{A}$	$T_j = 125^\circ\text{C}$	2.4		
$t_{rr}$	Reverse Recovery Time	$I_F = 15\text{A}$ $V_R = 800\text{V}$ $di/dt = 200\text{A}/\mu\text{s}$	$T_j = 25^\circ\text{C}$	240		ns
			$T_j = 125^\circ\text{C}$	290		
$Q_{rr}$	Reverse Recovery Charge		$T_j = 25^\circ\text{C}$	260		nC
			$T_j = 125^\circ\text{C}$	960		

## Thermal and package characteristics

Symbol	Characteristic	Min	Typ	Max	Unit	
R <sub>thJC</sub>	Junction to Case Thermal Resistance	IGBT		0.9	°C/W	
		Diode		2		
V <sub>ISOL</sub>	RMS Isolation Voltage, any terminal to case t=1 min, I isol<1mA, 50/60Hz	2500			V	
T <sub>J</sub>	Operating junction temperature range	-40		150	°C	
T <sub>STG</sub>	Storage Temperature Range	-40		125		
T <sub>C</sub>	Operating Case Temperature	-40		100		
Torque	Mounting torque	To heatsink	M4	2.5	4.7	N.m
Wt	Package Weight			80		g

## Temperature sensor NTC (see application note APT0406 on www.microsemi.com for more information).

Symbol	Characteristic	Min	Typ	Max	Unit
R <sub>25</sub>	Resistance @ 25°C		50		kΩ
B <sub>25/85</sub>	T <sub>25</sub> = 298.15 K		3952		K

$$R_T = \frac{R_{25}}{\exp\left[B_{25/85}\left(\frac{1}{T_{25}} - \frac{1}{T}\right)\right]}$$

T: Thermistor temperature  
 R<sub>T</sub>: Thermistor value at T

## SP1 Package outline (dimensions in mm)

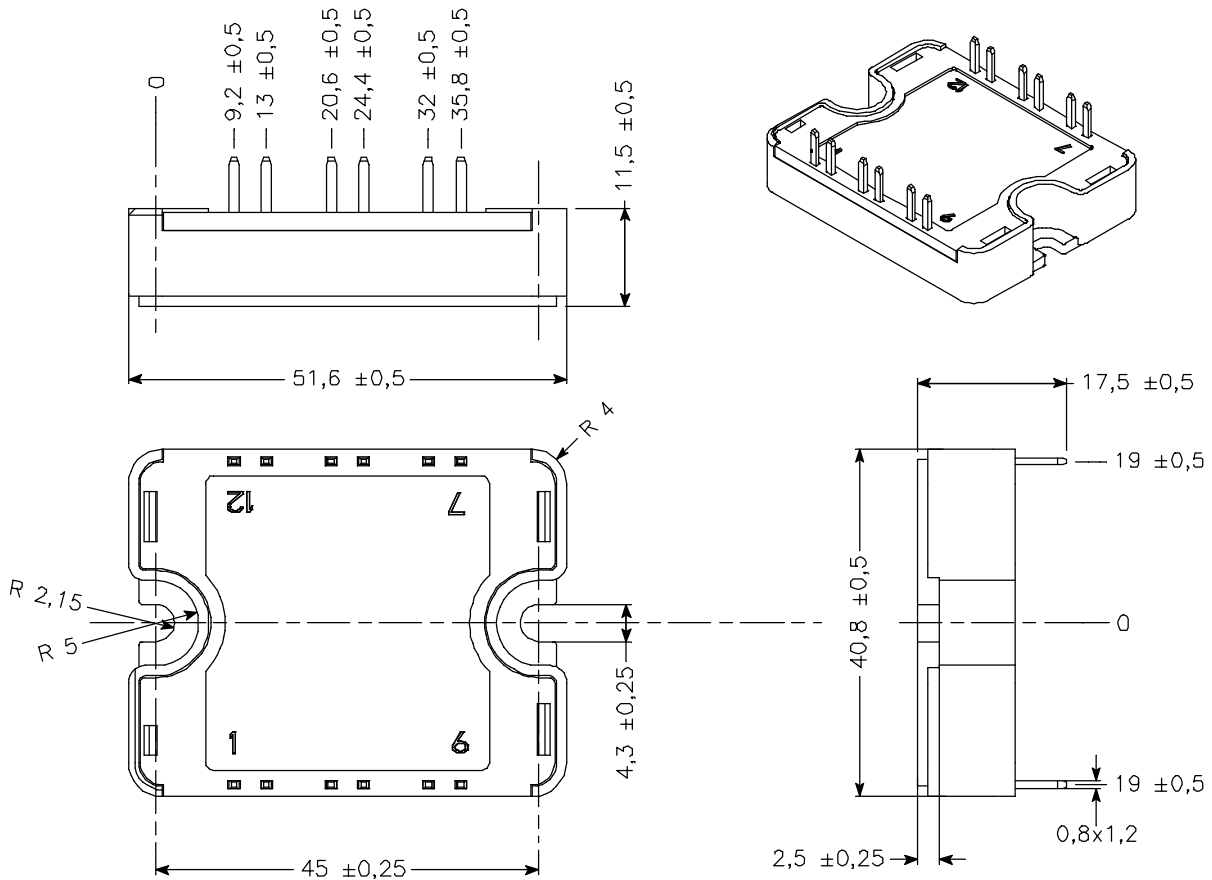

See application note 1904 - Mounting Instructions for SP1 Power Modules on [www.microsemi.com](http://www.microsemi.com)

## Typical Performance Curve

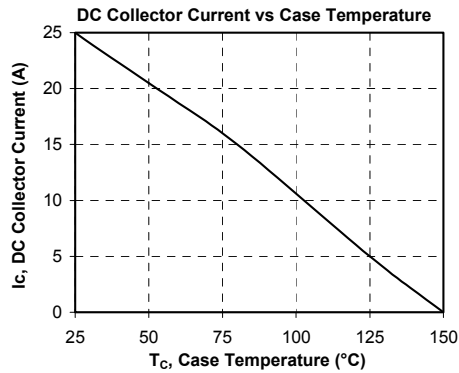
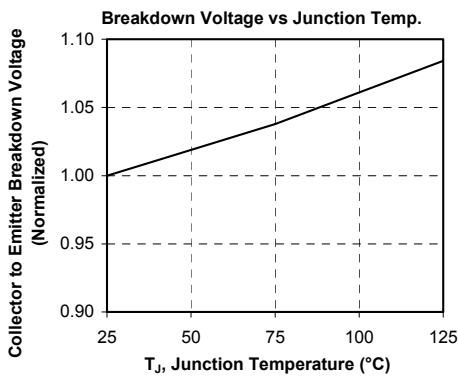
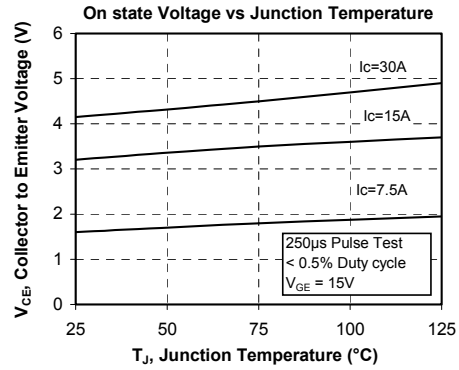
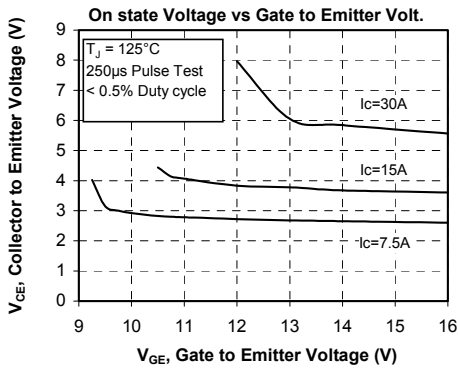
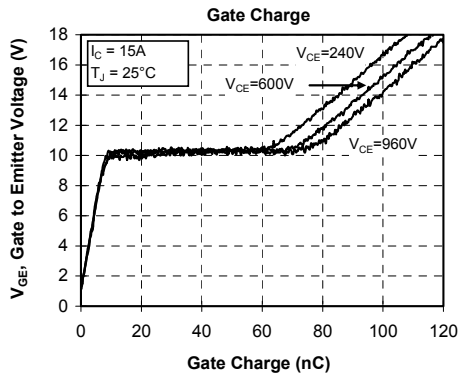
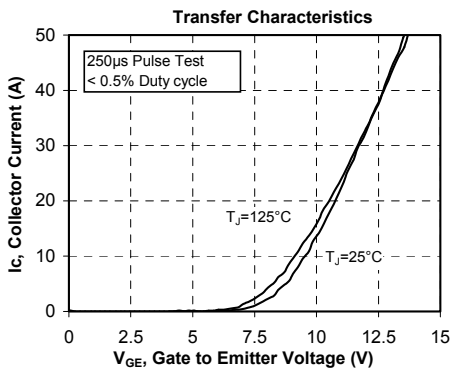
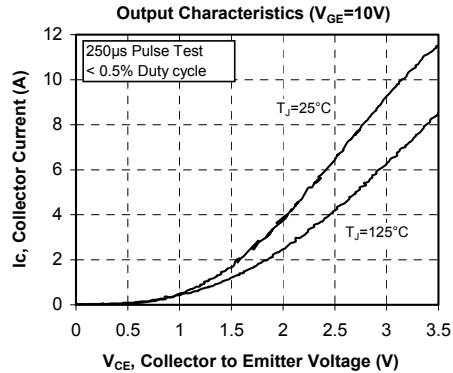
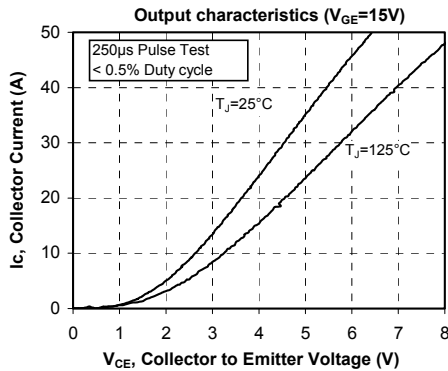

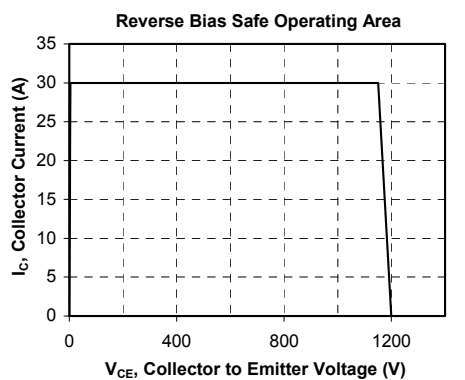
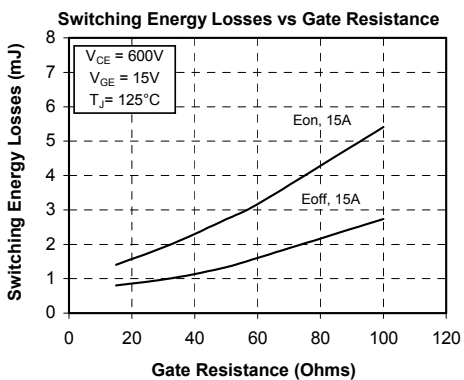
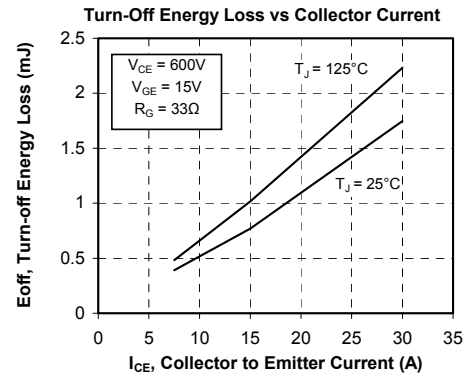
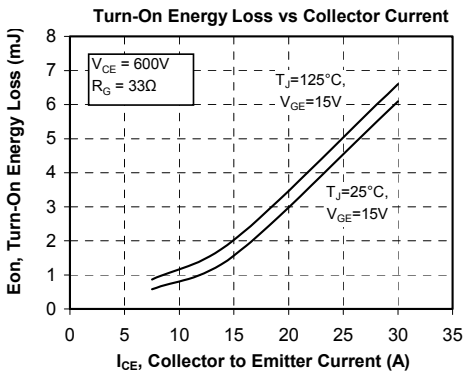
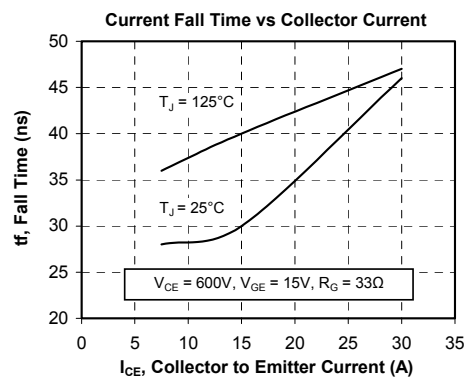
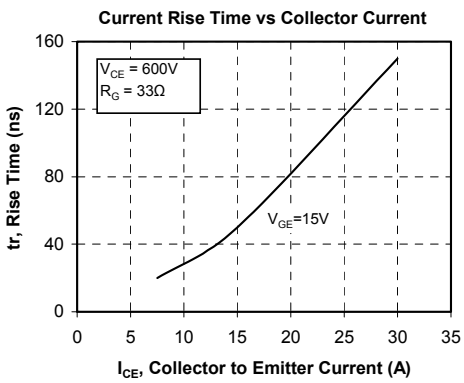
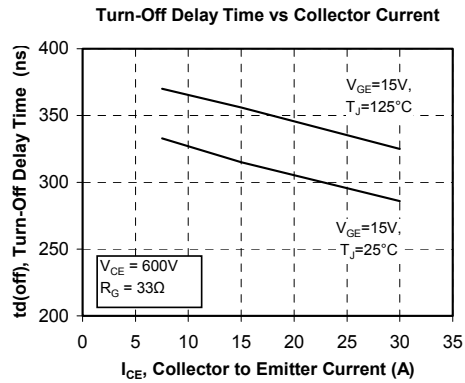
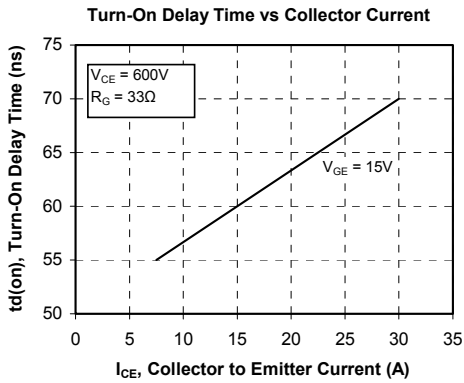

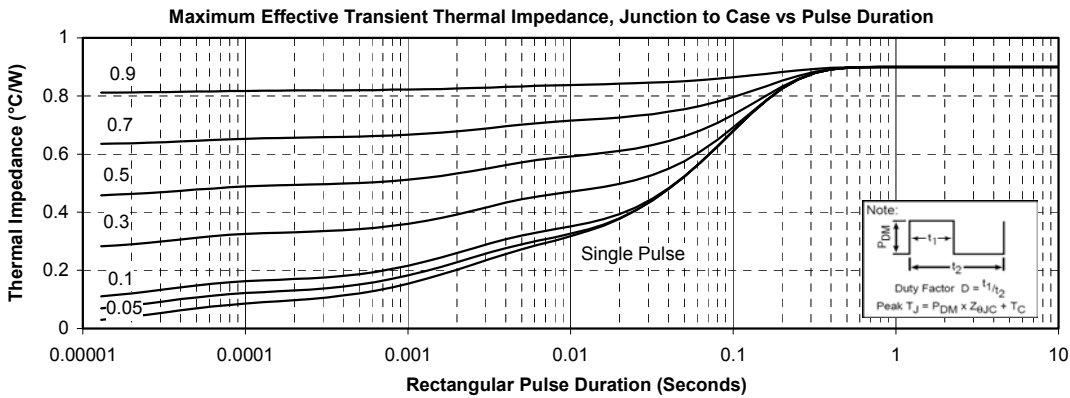
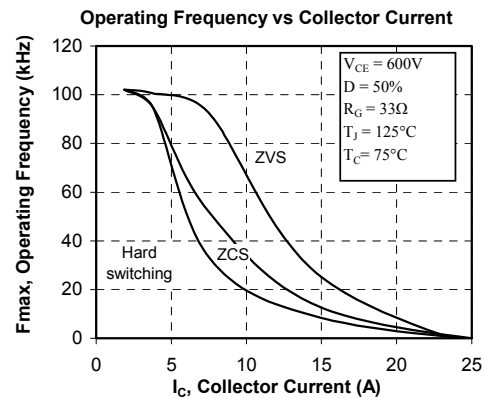
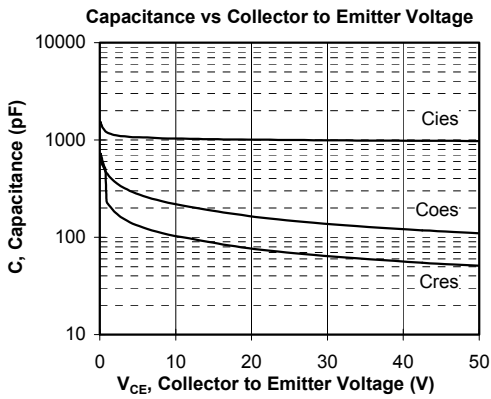

Microsemi reserves the right to change, without notice, the specifications and information contained herein

Microsemi's products are covered by one or more of U.S. patents 4,895,810 5,045,903 5,089,434 5,182,234 5,019,522 5,262,336 6,503,786 5,256,583 4,748,103 5,283,202 5,231,474 5,434,095 5,528,058 and foreign patents. U.S. and Foreign patents pending. All Rights Reserved.