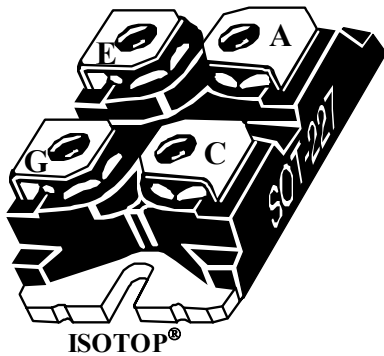
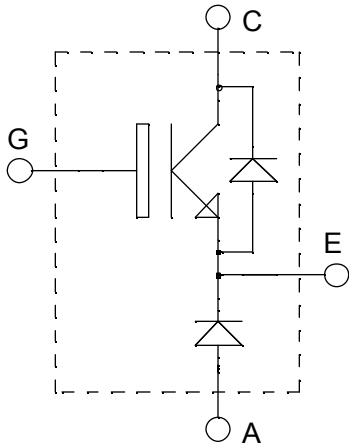


**ISOTOP[®] Buck chopper
NPT IGBT**
 $V_{CES} = 600V$
 $I_C = 30A @ T_c = 100^\circ C$

Application

- AC and DC motor control
- Switched Mode Power Supplies

Features

- Non Punch Through (NPT) THUNDERBOLT IGBT[®]
 - Low voltage drop
 - Low tail current
 - Switching frequency up to 100 kHz
 - Soft recovery parallel diodes
 - Low diode VF
 - Low leakage current
 - Avalanche energy rated
 - RBSOA and SCSOA rated
- ISOTOP[®] Package (SOT-227)
- Very low stray inductance
- High level of integration

Benefits

- Outstanding performance at high frequency operation
- Stable temperature behavior
- Very rugged
- Direct mounting to heatsink (isolated package)
- Low junction to case thermal resistance
- Easy paralleling due to positive T_C of V_{CEsat}
- RoHS Compliant

Absolute maximum ratings

Symbol	Parameter	Max ratings	Unit
V_{CES}	Collector - Emitter Breakdown Voltage	600	V
I_{C1}	Continuous Collector Current	$T_C = 25^\circ C$	A
I_{C2}		$T_C = 100^\circ C$	
I_{CM}	Pulsed Collector Current	$T_C = 25^\circ C$	110
V_{GE}	Gate - Emitter Voltage	± 20	V
P_D	Maximum Power Dissipation	$T_C = 25^\circ C$	192
I_{LM}	RBSOA clamped Inductive load Current $R_G = 11\Omega$	$T_C = 25^\circ C$	60
I_{FAV}	Maximum Average Forward Current	Duty cycle=0.5 $T_C = 80^\circ C$	30
I_{FRMS}	RMS Forward Current (Square wave, 50% duty)		39

 **CAUTION:** These Devices are sensitive to Electrostatic Discharge. Proper Handling Procedures Should Be Followed.

All ratings @ $T_j = 25^\circ\text{C}$ unless otherwise specified

Electrical Characteristics

<i>Symbol</i>	<i>Characteristic</i>	<i>Test Conditions</i>	<i>Min</i>	<i>Typ</i>	<i>Max</i>	<i>Unit</i>
I_{CES}	Zero Gate Voltage Collector Current	$V_{GE} = 0\text{V}$			40	μA
		$V_{CE} = 600\text{V}$			1000	
$V_{CE(sat)}$	Collector Emitter saturation Voltage	$V_{GE} = 15\text{V}$		2.0	2.5	V
		$I_C = 30\text{A}$		2.2	2.8	
$V_{GE(th)}$	Gate Threshold Voltage	$V_{GE} = V_{CE}, I_C = 700\mu\text{A}$	3	4	5	V
I_{GES}	Gate – Emitter Leakage Current	$V_{GE} = \pm 20\text{V}, V_{CE} = 0\text{V}$			± 100	nA

Dynamic Characteristics

<i>Symbol</i>	<i>Characteristic</i>	<i>Test Conditions</i>	<i>Min</i>	<i>Typ</i>	<i>Max</i>	<i>Unit</i>
C_{ies}	Input Capacitance	$V_{GE} = 0\text{V}$		1600	1850	pF
C_{oes}	Output Capacitance	$V_{CE} = 25\text{V}$		150	220	
C_{res}	Reverse Transfer Capacitance	$f = 1\text{MHz}$		90	150	
Q_g	Total gate Charge	$V_{GS} = 15\text{V}$		140	210	nC
Q_{ge}	Gate – Emitter Charge	$V_{Bus} = 300\text{V}$		10	15	
Q_{gc}	Gate – Collector Charge	$I_C = 30\text{A}$		60	90	
$T_{d(on)}$	Turn-on Delay Time	Resistive Switching (25°C)		13	26	ns
T_r	Rise Time	$V_{GE} = 15\text{V}$		41	80	
$T_{d(off)}$	Turn-off Delay Time	$V_{Bus} = 300\text{V}$		147	220	
T_f	Fall Time	$I_C = 30\text{A}$		200	400	
$T_{d(on)}$	Turn-on Delay Time	Inductive Switching (25°C)		17	30	ns
T_r	Rise Time	$V_{GE} = 15\text{V}$		28	60	
$T_{d(off)}$	Turn-off Delay Time	$V_{Bus} = 400\text{V}$		242	360	
T_f	Fall Time	$I_C = 30\text{A}$		34	70	
E_{ts}	Total switching Losses	$R_G = 10\Omega$		1.2	2	mJ
$T_{d(on)}$	Turn-on Delay Time	Inductive Switching (150°C)		15	30	ns
T_r	Rise Time	$V_{GE} = 15\text{V}$		27	50	
$T_{d(off)}$	Turn-off Delay Time	$V_{Bus} = 400\text{V}$		265	400	
T_f	Fall Time	$I_C = 30\text{A}$		41	80	
E_{on}	Turn-on Switching Energy	$R_G = 10\Omega$		0.5	1	mJ
E_{off}	Turn-off Switching Energy			1	2	
E_{ts}	Total switching Losses			1.5	3	

Chopper diode ratings and characteristics

<i>Symbol</i>	<i>Characteristic</i>	<i>Test Conditions</i>		<i>Min</i>	<i>Typ</i>	<i>Max</i>	<i>Unit</i>
V _F	Diode Forward Voltage	I _F = 30A			1.6	1.8	V
		I _F = 60A			1.9		
		I _F = 30A	T _j = 125°C		1.4		
I _{RM}	Maximum Reverse Leakage Current	V _R = 600V	T _j = 25°C			250	μA
		V _R = 600V	T _j = 125°C			500	
C _T	Junction Capacitance	V _R = 200V			44		pF
t _{rr}	Reverse Recovery Time	I _F =1A, V _R =30V di/dt = 100A/μs	T _j = 25°C		23		ns
	Reverse Recovery Time		T _j = 25°C		85		
			T _j = 125°C		160		
I _{RRM}	Maximum Reverse Recovery Current	I _F = 30A V _R = 400V di/dt = 200A/μs	T _j = 25°C		4		A
			T _j = 125°C		8		
Q _{rr}	Reverse Recovery Charge		T _j = 25°C		130		nC
			T _j = 125°C		700		
t _{rr}	Reverse Recovery Time	I _F = 30A	T _j = 125°C		70		ns
Q _{rr}	Reverse Recovery Charge	V _R = 400V			1300		nC
I _{RRM}	Maximum Reverse Recovery Current	di/dt = 1000A/μs			30		A

Thermal and package characteristics

<i>Symbol</i>	<i>Characteristic</i>		<i>Min</i>	<i>Typ</i>	<i>Max</i>	<i>Unit</i>
R _{thJC}	Junction to Case Thermal Resistance	IGBT			0.65	°C/W
		Diode			1.21	
R _{thJA}	Junction to Ambient (IGBT & Diode)				20	
V _{ISOL}	RMS Isolation Voltage, any terminal to case t = 1 min, I _{isol} < 1mA, 50/60Hz		2500			V
T _J , T _{STG}	Storage Temperature Range		-55		150	°C
T _L	Max Lead Temp for Soldering: 0.063" from case for 10 sec				300	
Torque	Mounting torque (Mounting = 8-32 or 4mm Machine and terminals = 4mm Machine)				1.5	N.m
Wt	Package Weight			29.2		g

Typical IGBT Performance Curve

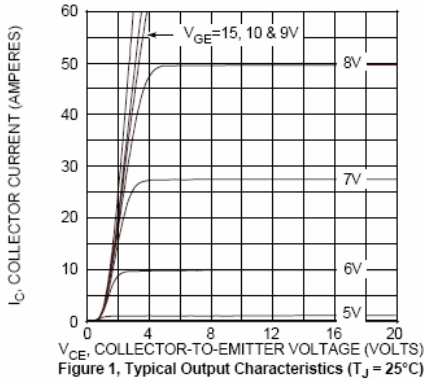


Figure 1, Typical Output Characteristics ($T_J = 25^\circ\text{C}$)

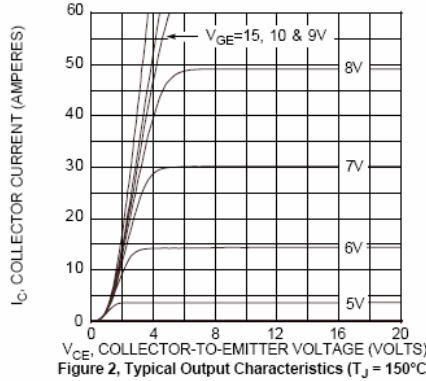


Figure 2, Typical Output Characteristics ($T_J = 150^\circ\text{C}$)

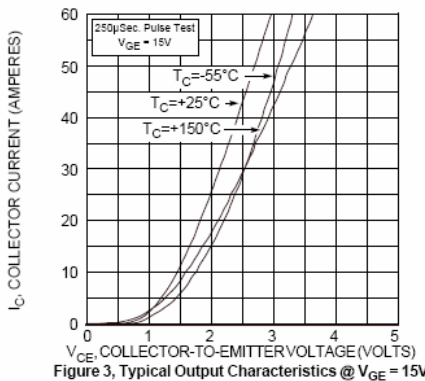


Figure 3, Typical Output Characteristics @ $V_{GE} = 15\text{V}$

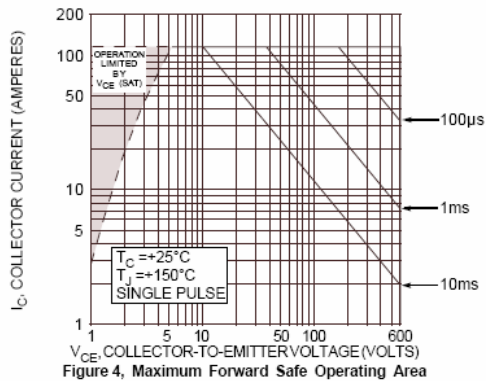


Figure 4, Maximum Forward Safe Operating Area

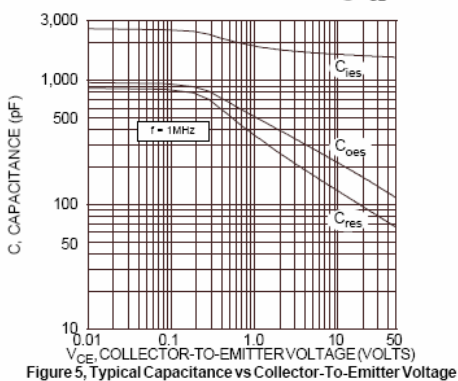


Figure 5, Typical Capacitance vs Collector-To-Emitter Voltage

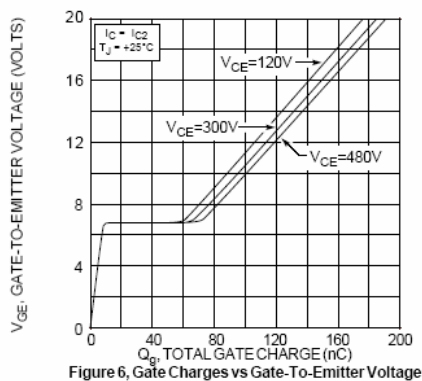


Figure 6, Gate Charges vs Gate-To-Emitter Voltage

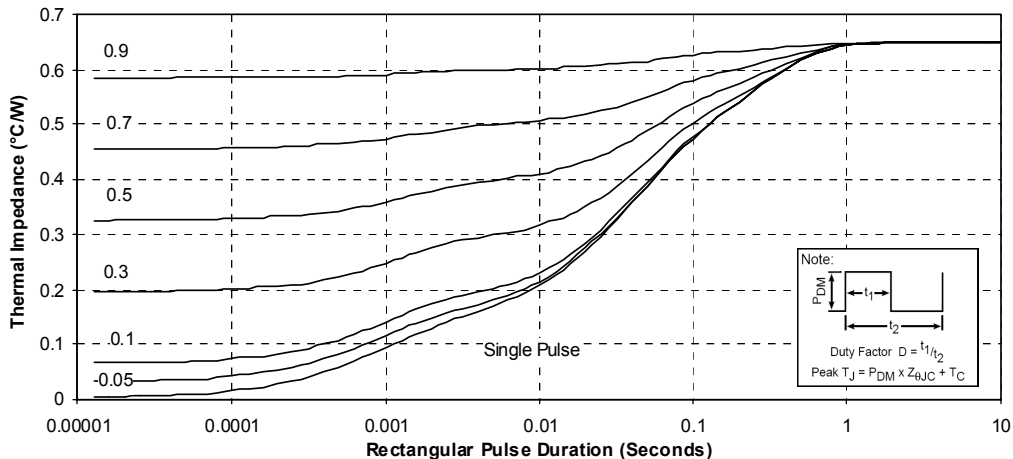


Figure 7, Maximum Effective Transient Thermal Impedance, Junction to Case vs Pulse Duration

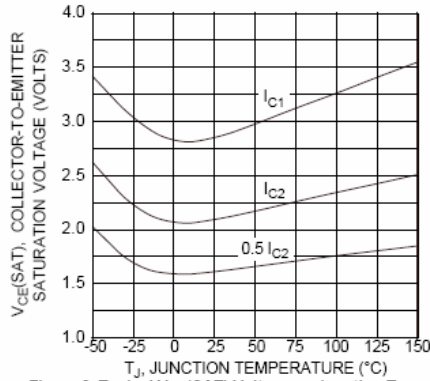


Figure 8, Typical $V_{CE(SAT)}$ Voltage vs Junction Temperature

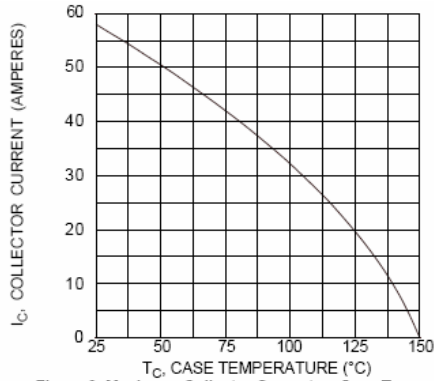


Figure 9, Maximum Collector Current vs Case Temperature

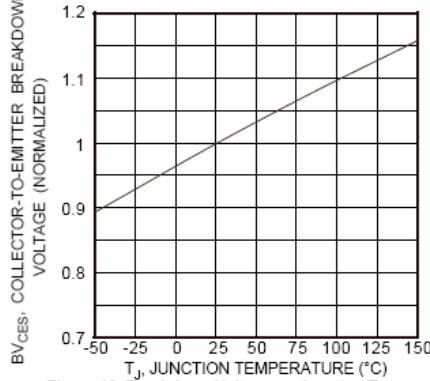


Figure 10, Breakdown Voltage vs Junction Temperature

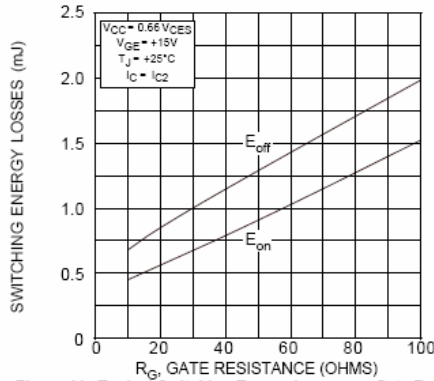


Figure 11, Typical Switching Energy Losses vs Gate Resistance

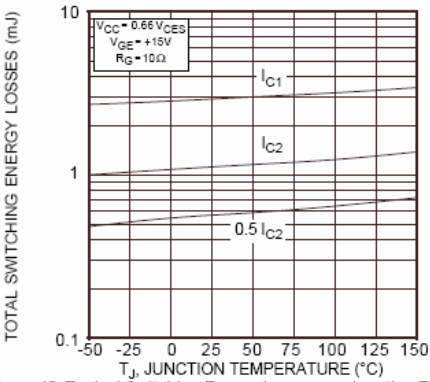


Figure 12, Typical Switching Energy Losses vs. Junction Temperature

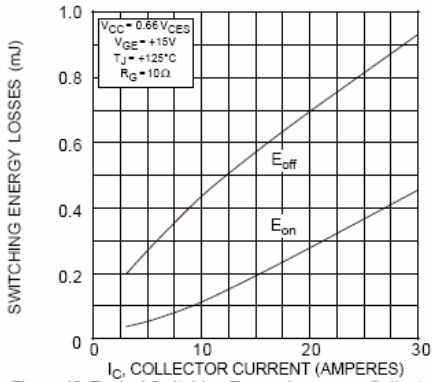


Figure 13, Typical Switching Energy Losses vs Collector Current

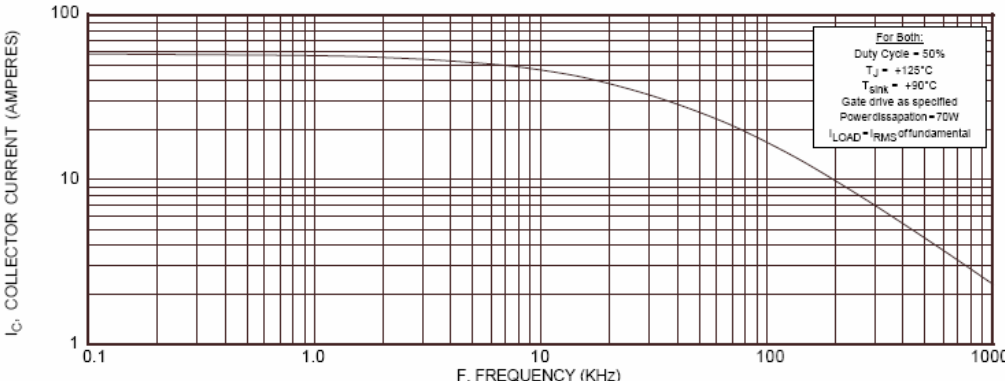


Figure 14, Typical Load Current vs Frequency

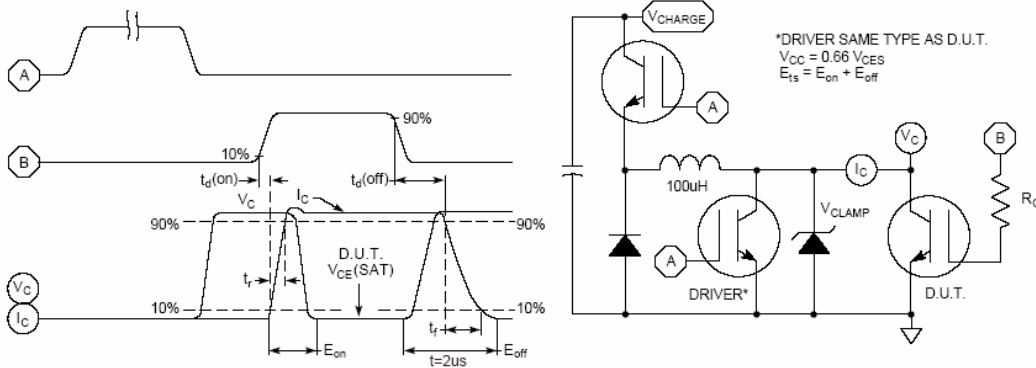


Figure 15, Switching Loss Test Circuit and Waveforms

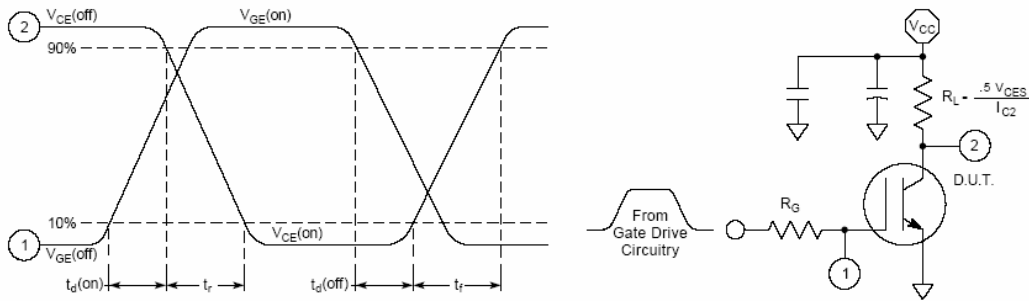


Figure 16, Resistive Switching Time Test Circuit and Waveforms

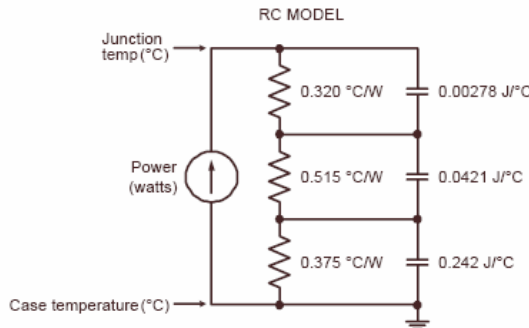
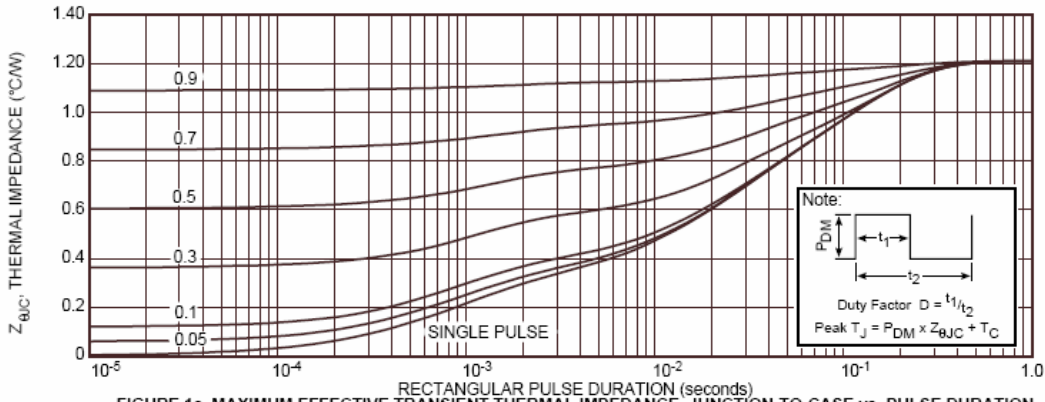
Typical Diode Performance Curve


FIGURE 1b, TRANSIENT THERMAL IMPEDANCE MODEL

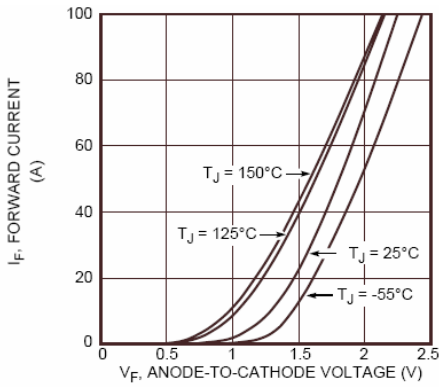


Figure 2. Forward Current vs. Forward Voltage

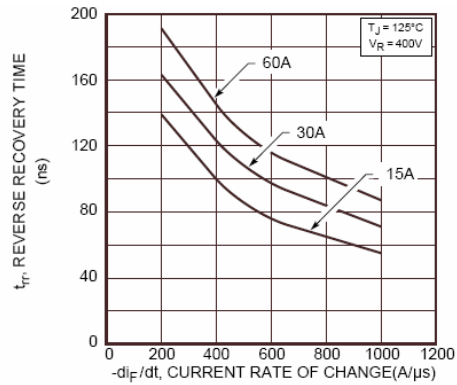


Figure 3. Reverse Recovery Time vs. Current Rate of Change



Figure 4. Reverse Recovery Charge vs. Current Rate of Change



Figure 5. Reverse Recovery Current vs. Current Rate of Change

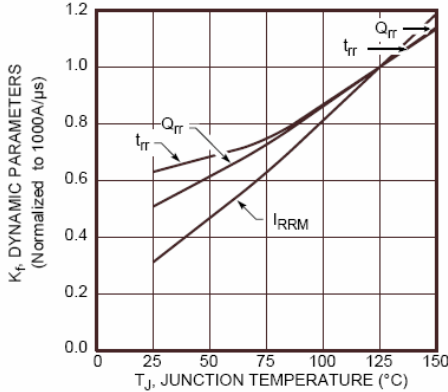


Figure 6. Dynamic Parameters vs. Junction Temperature

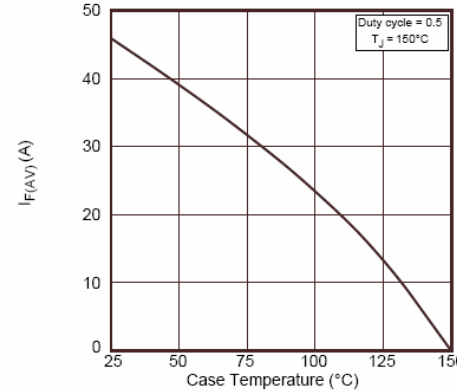


Figure 7. Maximum Average Forward Current vs. Case Temperature

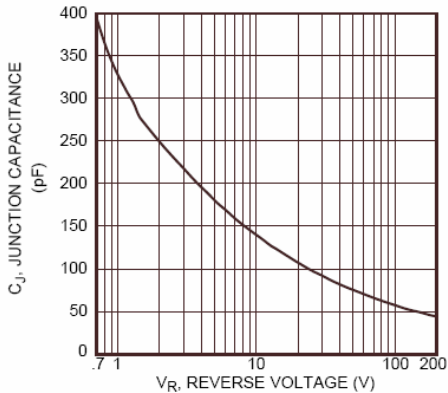


Figure 8. Junction Capacitance vs. Reverse Voltage

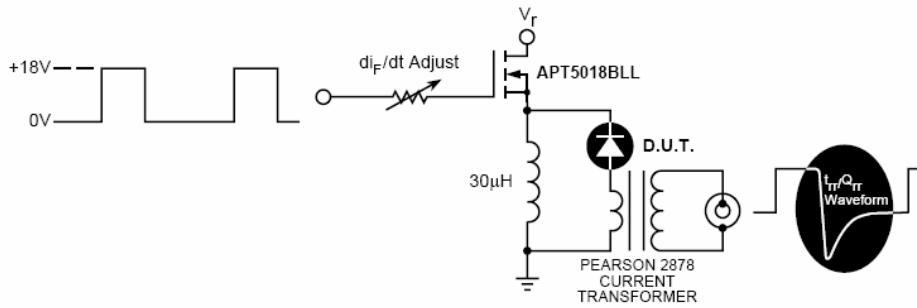


Figure 9. Diode Test Circuit

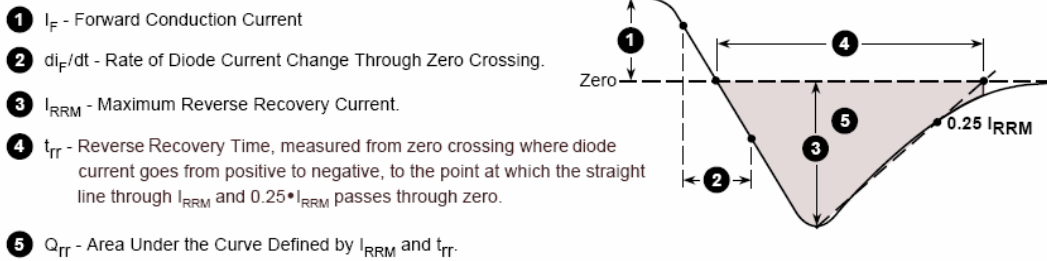
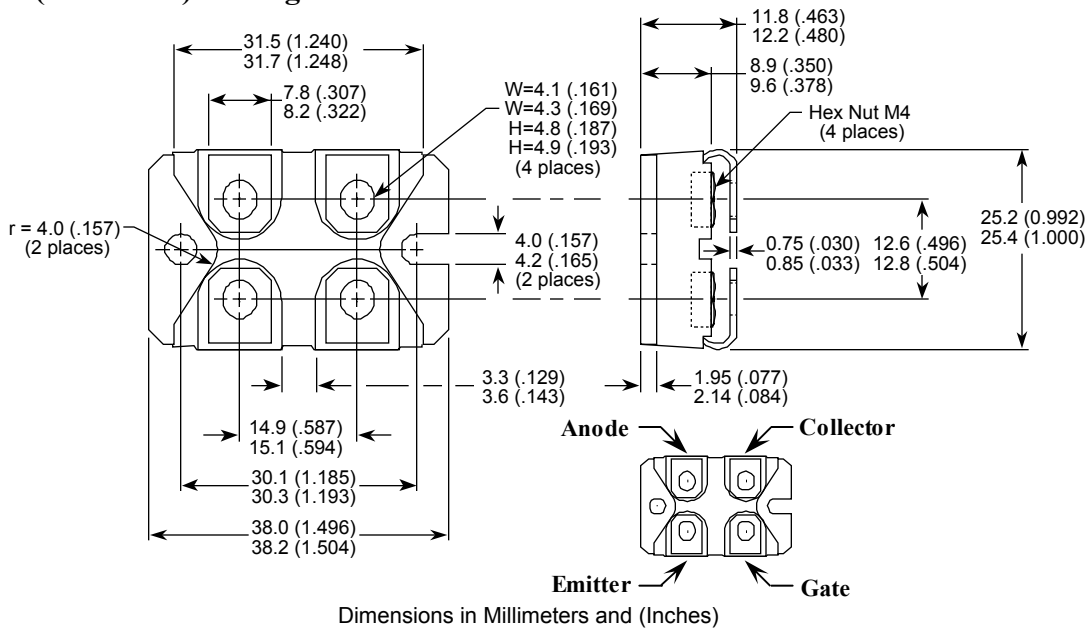


Figure 10. Diode Reverse Recovery Waveform and Definitions

SOT-227 (ISOTOP®) Package Outline



ISOTOP® is a registered trademark of ST Microelectronics NV

Microsemi reserves the right to change, without notice, the specifications and information contained herein

Microsemi's products are covered by one or more of U.S. patents 4,895,810 5,045,903 5,089,434 5,182,234 5,019,522 5,262,336 6,503,786 5,256,583 4,748,103 5,283,202 5,231,474 5,434,095 5,528,058 and foreign patents. U.S. and Foreign patents pending. All Rights Reserved.