

Fast Recovery Epitaxial Diode (FRED)

$I_{FAVM} = 2x30 \text{ A}$
 $V_{RRM} = 1000 \text{ V}$
 $t_{rr} = 35 \text{ ns}$

| V_{RSM} | V_{RRM} | Type |
|-----------|-----------|----------------|
| V | V | |
| 1000 | 1000 | DSEI 2x 30-10P |

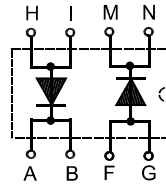

| Symbol | Conditions | Maximum Ratings (per diode) | |
|---------------|--|-----------------------------|------------------|
| I_{FRMS} | $T_{VJ} = T_{VJM}$ | 70 | A |
| I_{FAVM} ① | $T_C = 50^\circ\text{C}$; rectangular; $d = 0.5$ | 30 | A |
| I_{FRM} | $t_p < 10 \mu\text{s}$; rep. rating; pulse width limited by T_{VJM} | 375 | A |
| I_{FSM} | $T_{VJ} = 45^\circ\text{C}$; $t = 10 \text{ ms}$ (50 Hz), sine | 200 | A |
| T_{VJ} | | -40...+150 | $^\circ\text{C}$ |
| T_{VJM} | | 150 | $^\circ\text{C}$ |
| T_{stg} | | -40...+150 | $^\circ\text{C}$ |
| P_{tot} | $T_C = 25^\circ\text{C}$ | 100 | W |
| V_{ISOL} | 50/60 Hz, RMS $I_{ISOL} \leq 1 \text{ mA}$ | $t = 1 \text{ min}$ | 2500 V~ |
| | | $t = 1 \text{ s}$ | 3000 V~ |
| M_d | Mounting torque (M4) | 1.5 - 2.0 | Nm |
| | | 14 - 18 | lb.in. |
| Weight | | 18 | g |

Features

- 2 independent FRED in 1 package
- Isolation voltage 3000 V~
- Planar passivated chips
- Leads suitable for PC board soldering
- Very short recovery time
- Soft recovery behaviour

Applications

- Antiparallel diode for high frequency switching devices
- Anti saturation diode
- Snubber diode
- Free wheeling diode in converters and motor control circuits
- Rectifiers in switch mode power supplies (SMPS)
- Inductive heating and melting
- Uninterruptible power supplies (UPS)
- Ultrasonic cleaners and welders

Advantages

- Easy to mount with two screws
- Space and weight savings
- Improved temperature and power cycling capability
- Low noise switching
- Small and light weight

| Symbol | Conditions | Characteristic Values (per diode) | |
|------------|---|-----------------------------------|------------------|
| | | typ. | max. |
| I_R | $T_{VJ} = 25^\circ\text{C}$ $V_R = V_{RRM}$ | 750 | μA |
| | $T_{VJ} = 25^\circ\text{C}$ $V_R = 0.8 \cdot V_{RRM}$ | 250 | μA |
| | $T_{VJ} = 125^\circ\text{C}$ $V_R = 0.8 \cdot V_{RRM}$ | 7 | mA |
| V_F | $I_F = 30 \text{ A}$; $T_{VJ} = 150^\circ\text{C}$ | 2.0 | V |
| | $T_{VJ} = 25^\circ\text{C}$ | 2.4 | V |
| V_{T0} | For power-loss calculations only | 1.5 | V |
| r_T | $T_{VJ} = T_{VJM}$ | 12.5 | m Ω |
| R_{thJC} | | 1.25 | K/W |
| R_{thCK} | 0.05 | | K/W |
| t_{rr} | $I_F = 1 \text{ A}$; $-di/dt = 100 \text{ A}/\mu\text{s}$ $V_R = 30 \text{ V}$; $T_{VJ} = 25^\circ\text{C}$ | 35 | ns |
| | | 50 | ns |
| I_{RM} | $V_R = 540 \text{ V}$; $I_F = 30 \text{ A}$; $-di/dt = 240 \text{ A}/\mu\text{s}$ $L \leq 0.05 \mu\text{H}$; $T_{VJ} = 100^\circ\text{C}$ | 16 | A |
| | | 18 | A |
| d_S | Creeping distance on surface | min. 11.2 | mm |
| d_A | Creeping distance in air | min. 11.2 | mm |
| a | Allowable acceleration | max. 50 | m/s ² |

① I_{FAVM} rating includes reverse blocking losses at T_{VJM} , $V_R = 0.8 V_{RRM}$, duty cycle $d = 0.5$
Data according to IEC 60747

**Recommended replacement:
DSEI 2x31-10P, DSEI 2x31-10B**

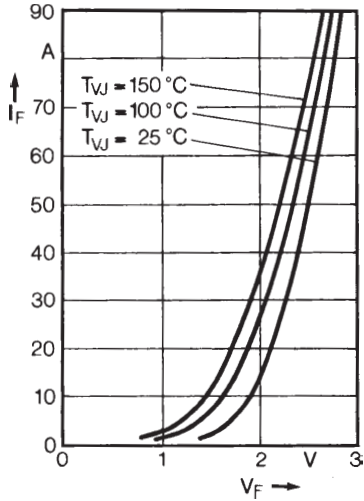

Fig. 1 Forward current versus voltage drop.

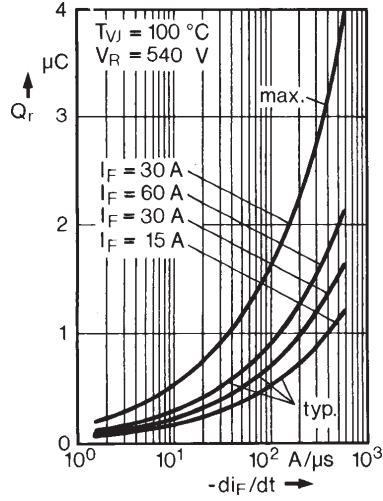

Fig. 2 Recovery charge versus $-di_F/dt$.

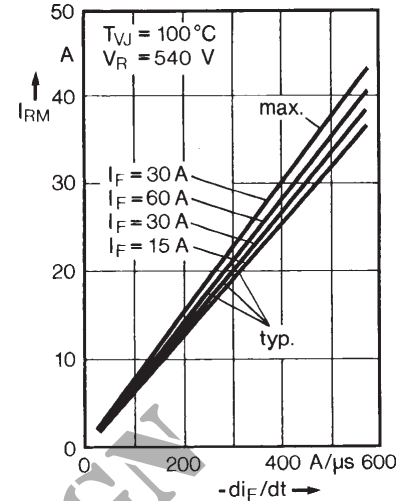

Fig. 3 Peak reverse current versus $-di_F/dt$.

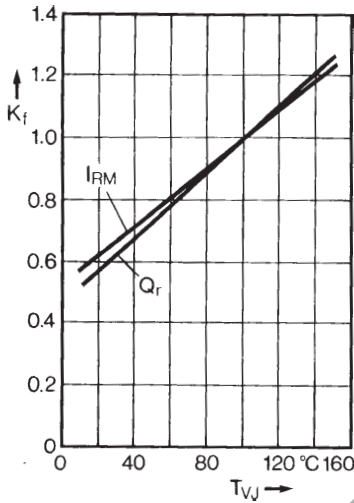

Fig. 4 Dynamic parameters versus junction temperature.

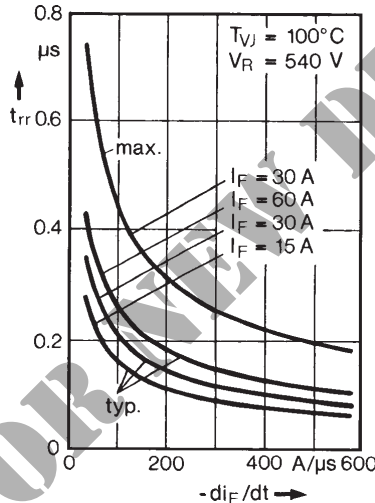

Fig. 5 Recovery time versus $-di_F/dt$.

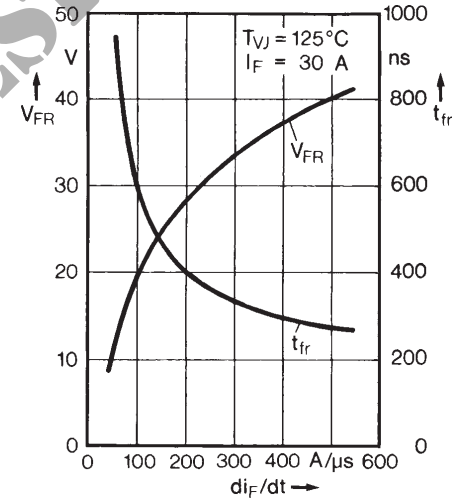

Fig. 6 Peak forward voltage versus di_F/dt .

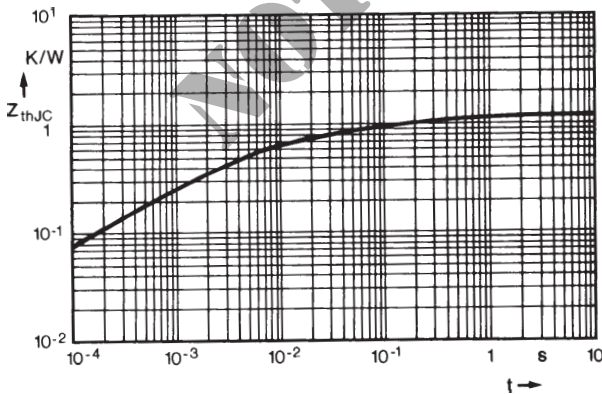

Fig. 7 Transient thermal impedance junction to case.

Dimensions in mm (1mm = 0.0394")

