

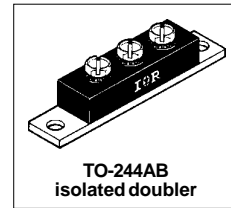

409DMQ... Series

SCHOTTKY RECTIFIER

400 Amp



Major Ratings and Characteristics

Characteristics	409DMQ...	Units
$I_{F(AV)}$ Rectangular waveform	400	A
V_{RRM}	135 to 150	V
I_{FSM} @ $t_p = 5 \mu s$ sine	25,500	A
V_F @ 200Apk, $T_J = 125^\circ C$ (per leg)	0.72	V
T_J range	-55 to 175	$^\circ C$

Description/ Features

The 409DMQ Schottky rectifier doubler module series has been optimized for low reverse leakage at high temperature. The proprietary barrier technology allows for reliable operation up to 175 °C junction temperature. Typical applications are in high current switching power supplies, plating power supplies, UPS systems, converters, free-wheeling diodes, welding, and reverse battery protection.

- 175 °C T_J operation
- High purity, high temperature epoxy encapsulation for enhanced mechanical strength and moisture resistance
- Low forward voltage drop
- High frequency operation
- Guard ring for enhanced ruggedness and long term reliability

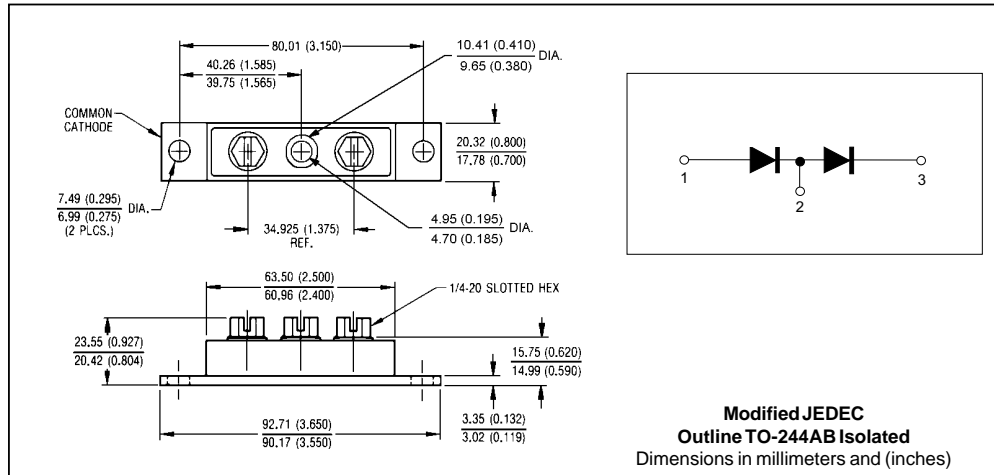

Voltage Ratings

Parameters	409DMQ135	409DMQ150
V_R Max. DC Reverse Voltage (V)	135	150
V_{RWM} Max. Working Peak Reverse Voltage (V)		

Absolute Maximum Ratings

Parameters	409DMQ	Units	Conditions
$I_{F(AV)}$ Max. Average Forward Current (Per Device)	400	A	50% duty cycle @ $T_C = 80^\circ\text{C}$, rectangular wave form
I_{FSM} Max. Peak One Cycle Non-Repetitive Surge Current (Per Leg)	20000	A	5 μs Sine or 3 μs Rect. pulse 10ms Sine or 6ms Rect. pulse
	2300		
E_{AS} Non-Repetitive Avalanche Energy (Per Leg)	15	mJ	$T_J = 25^\circ\text{C}$, $I_{AS} = 1$ Amps, $L = 30$ mH
I_{AR} Repetitive Avalanche Current (Per Leg)	1	A	Current decaying linearly to zero in 1 μsec Frequency limited by T_J max. $V_A = 1.5 \times V_R$ typical

Electrical Specifications

Parameters	409DMQ	Units	Conditions
V_{FM} Max. Forward Voltage Drop (Per Leg) (1)	1.03	V	@ 200A $T_J = 25^\circ\text{C}$
	1.21	V	@ 400A
	0.71	V	@ 200A $T_J = 125^\circ\text{C}$
	0.82	V	@ 400A
I_{RM} Max. Reverse Leakage Current (Per Leg) (1)	6	mA	$T_J = 25^\circ\text{C}$
	85	mA	$T_J = 125^\circ\text{C}$ $V_R = \text{rated } V_R$
C_T Max. Junction Capacitance (Per Leg)	6000	pF	$V_R = 5V_{DC}$, (test signal range 100Khz to 1Mhz) 25°C
L_S Typical Series Inductance (Per Leg)	5.0	nH	From top of terminal hole to mounting plane
dv/dt Max. Voltage Rate of Change (Rated V_R)	10000	V/ μs	

(1) Pulse Width < 300 μs , Duty Cycle < 2%

Thermal-Mechanical Specifications

Parameters	409DMQ	Units	Conditions
T_J Max. Junction Temperature Range	-55 to 175	$^\circ\text{C}$	
T_{stg} Max. Storage Temperature Range	-55 to 175	$^\circ\text{C}$	
R_{thJC} Max. Thermal Resistance Junction to Case (Per Leg)	0.4	$^\circ\text{C/W}$	DC operation
R_{thJC} Max. Thermal Resistance Junction to Case (Per Package)	0.2	$^\circ\text{C/W}$	DC operation
R_{thCS} Typical Thermal Resistance, Case to Heatsink	0.1	$^\circ\text{C/W}$	Mounting surface, smooth and greased
wt Approximate Weight	79(2.80)	g(oz.)	
T Mounting Torque Base	Min.	24(20)	Kg-cm (lbf-in)
	Max.	35(30)	
	Typ.	13.5(12)	
	Terminal Torque	Min.	
	Max.	46(40)	
Case Style	TO - 244AB isolated doubler		Modified JEDEC

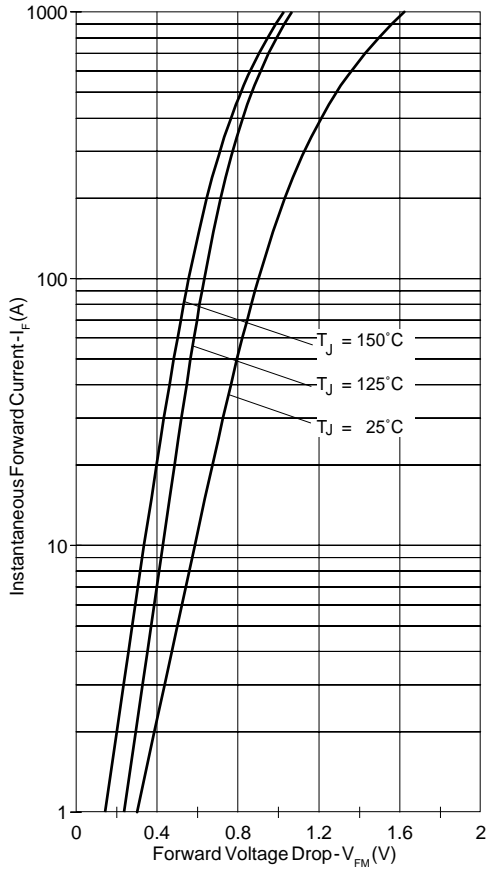

Fig. 1 - Max. Forward Voltage Drop Characteristics

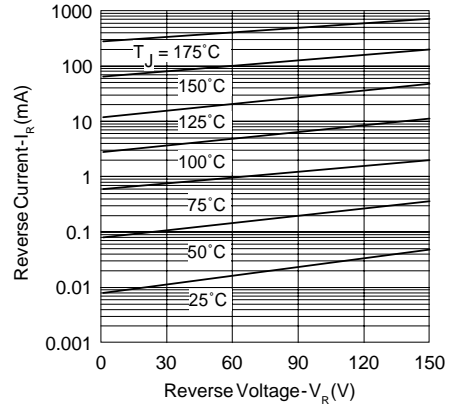

Fig. 2 - Typical Values Of Reverse Current Vs. Reverse Voltage

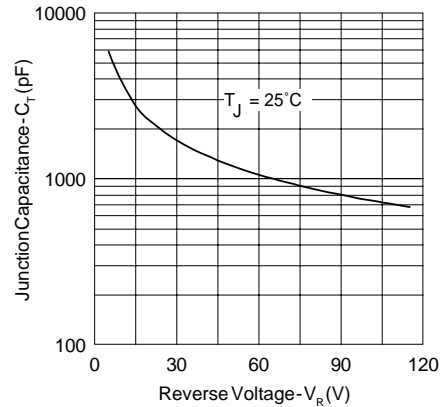

Fig. 3 - Typical Junction Capacitance Vs. Reverse Voltage

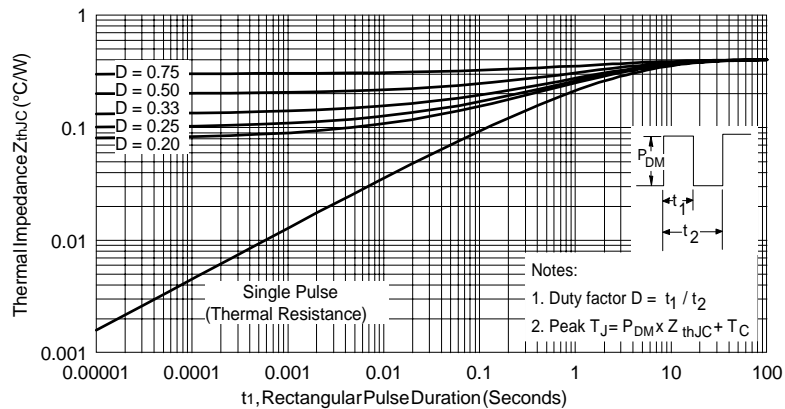

Fig. 4 - Max. Thermal Impedance Z_{thJC} Characteristics

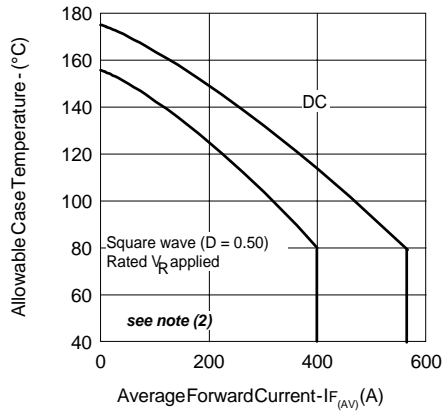

Fig. 5 - Max. Allowable Case Temperature Vs. Average Forward Current

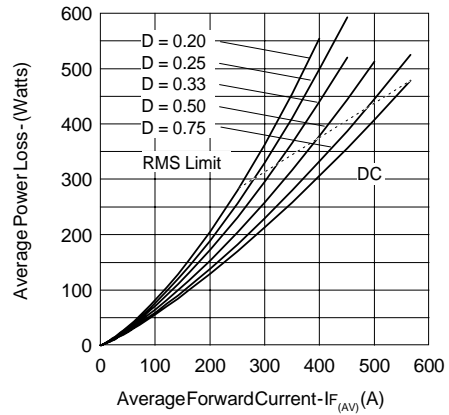

Fig. 6 - Forward Power Loss Characteristics

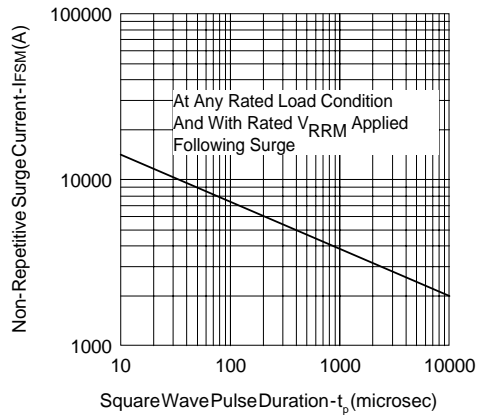

Fig. 7 - Max. Non-Repetitive Surge Current

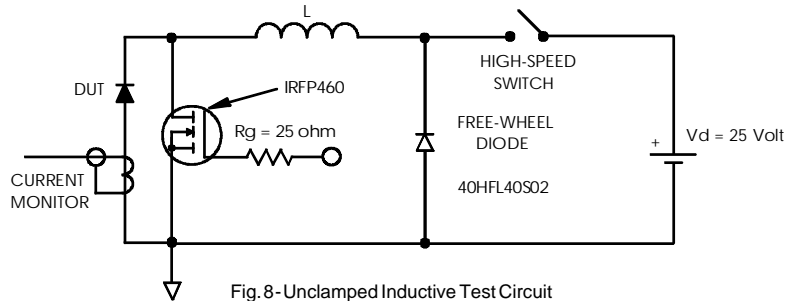

Fig. 8 - Unclamped Inductive Test Circuit

- (2) Formula used: $T_c = T_j - (P_d + P_{d_{REV}}) \times R_{thJC}$;
 $P_d = \text{Forward Power Loss} = I_{F(AV)} \times V_{FM} @ (I_{F(AV)} / D)$ (see Fig. 6);
 $P_{d_{REV}} = \text{Inverse Power Loss} = V_{R1} \times I_R (1 - D)$; $I_R @ V_{R1} = 80\% \text{ rated } V_R$

Data and specifications subject to change without notice.
This product has been designed and qualified for Industrial Level.
Qualification Standards can be found on IR's Web site.

International
IR Rectifier

IR WORLD HEADQUARTERS: 233 Kansas St., El Segundo, California 90245, USA Tel: (310) 252-7105
TAC Fax: (310) 252-7309
Visit us at www.irf.com for sales contact information. 10/02