

**Major Ratings and Characteristics**

Characteristics	249NQ...(R)	Units
$I_{F(AV)}$ Rectangular waveform	240	A
$V_{RRM}$ range	135 to 150	V
$I_{FSM}$ @ $t_p = 5 \mu s$ sine	20000	A
$V_F$ @ 240Apk, $T_J = 125^\circ C$	0.72	V
$T_J$ range	-55 to 175	$^\circ C$

**Description/ Features**

The 249NQ...(R) high current Schottky rectifier module series has been optimized for low reverse leakage at high temperature. The proprietary barrier technology allows for reliable operation up to 175 $^\circ C$  junction temperature. Typical applications are in switching power supplies, converters, free-wheeling diodes, and reverse battery protection.

- 175 $^\circ C$   $T_J$  operation
- Unique high power, Half-Pak module
- Replaces four parallel DO-5's
- Easier to mount and lower profile than DO-5's
- High purity, high temperature epoxy encapsulation for enhanced mechanical strength and moisture resistance
- Low forward voltage drop
- High frequency operation
- Guard ring for enhanced ruggedness and long term reliability

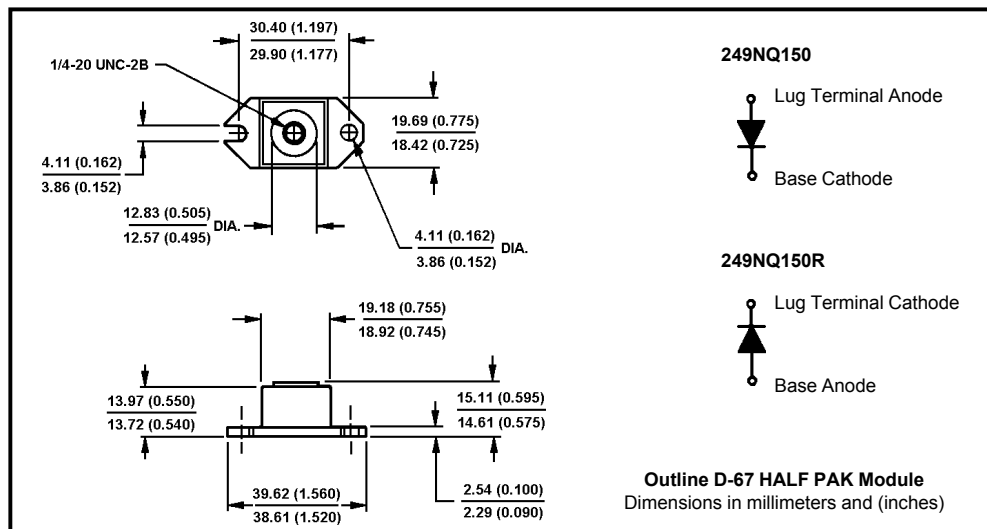

## Voltage Ratings

Part number	249NQ135	249NQ150
$V_R$ Max. DC Reverse Voltage (V)	135	150
$V_{RWM}$ Max. Working Peak Reverse Voltage (V)		

## Absolute Maximum Ratings

Parameters	249NQ	Units	Conditions
$I_{F(AV)}$ Max. Average Forward Current * See Fig. 5	240	A	50% duty cycle @ $T_C = 117^\circ\text{C}$ , rectangular wave form
$I_{FSM}$ Max. Peak One Cycle Non-Repetitive Surge Current * See Fig. 7	20000	A	5 $\mu\text{s}$ Sine or 3 $\mu\text{s}$ Rect. pulse
	2300		10ms Sine or 6ms Rect. pulse
$E_{AS}$ Non-Repetitive Avalanche Energy	15	mJ	$T_J = 25^\circ\text{C}$ , $I_{AS} = 1\text{ Amps}$ , $L = 30\text{ mH}$
$I_{AR}$ Repetitive Avalanche Current	1	A	Current decaying linearly to zero in 1 $\mu\text{sec}$ Frequency limited by $T_J$ max. $V_A = 1.5 \times V_R$ typical

## Electrical Specifications

Parameters	249NQ	Units	Conditions
$V_{FM}$ Max. Forward Voltage Drop (1) * See Fig. 1	1.07	V	@ 240A
	1.27	V	@ 480A
	0.74	V	@ 240A
	0.86	V	@ 480A
$I_{RM}$ Max. Reverse Leakage Current (1) * See Fig. 2	6	mA	$T_J = 25^\circ\text{C}$
	85	mA	$T_J = 125^\circ\text{C}$
$C_T$ Max. Junction Capacitance	6000	pF	$V_R = 5V_{DC}$ , (test signal range 100Khz to 1Mhz) $25^\circ\text{C}$
$L_S$ Typical Series Inductance	5.0	nH	From top of terminal hole to mounting plane
dv/dt Max. Voltage Rate of Change	10000	V/ $\mu\text{s}$	(Rated $V_R$ )

(1) Pulse Width < 300 $\mu\text{s}$ , Duty Cycle < 2%

## Thermal-Mechanical Specifications

Parameters	249NQ	Units	Conditions	
$T_J$ Max. Junction Temperature Range	-55 to 175	$^\circ\text{C}$		
$T_{stg}$ Max. Storage Temperature Range	-55 to 175	$^\circ\text{C}$		
$R_{thJC}$ Max. Thermal Resistance Junction to Case	0.20	$^\circ\text{C}/\text{W}$	DC operation * See Fig. 4	
$R_{thCS}$ Typical Thermal Resistance, Case to Heatsink	0.15	$^\circ\text{C}/\text{W}$	Mounting surface, smooth and greased	
wt Approximate Weight	25.6(0.9)	g(oz.)		
T Mounting Torque	Min.	40(35)	Non-lubricated threads	
	Max.	58(50)		
	Terminal Torque	Min.		58(50)
		Max.		86(75)
Case Style	HALF PAK Module			

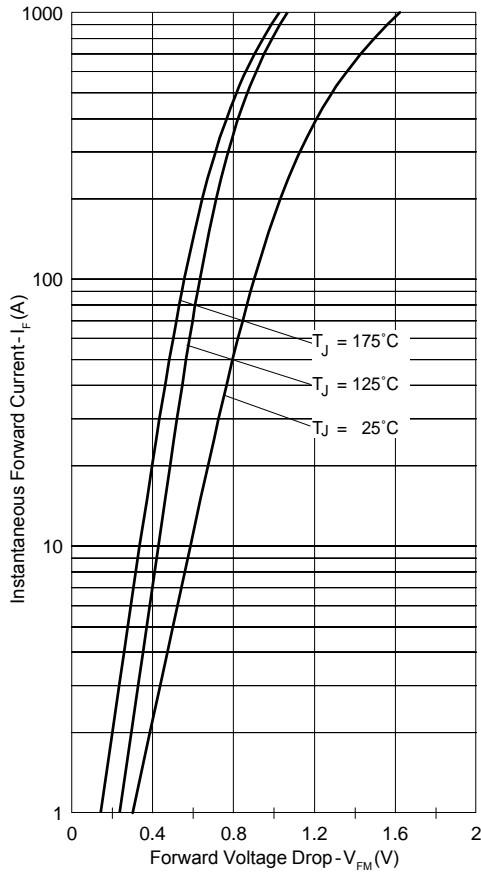

Fig. 1 - Max. Forward Voltage Drop Characteristics

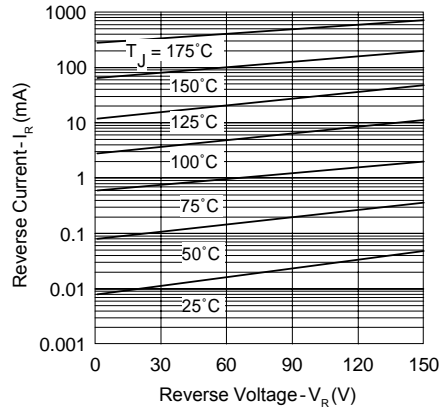

Fig. 2 - Typical Values Of Reverse Current Vs. Reverse Voltage

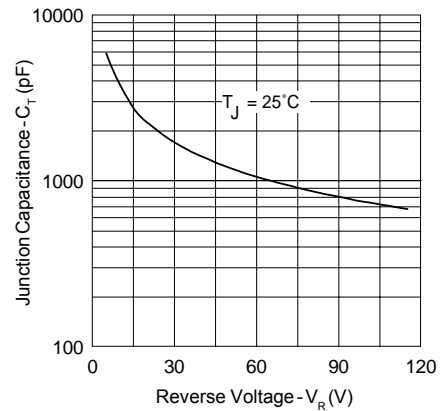

Fig. 3 - Typical Junction Capacitance Vs. Reverse Voltage

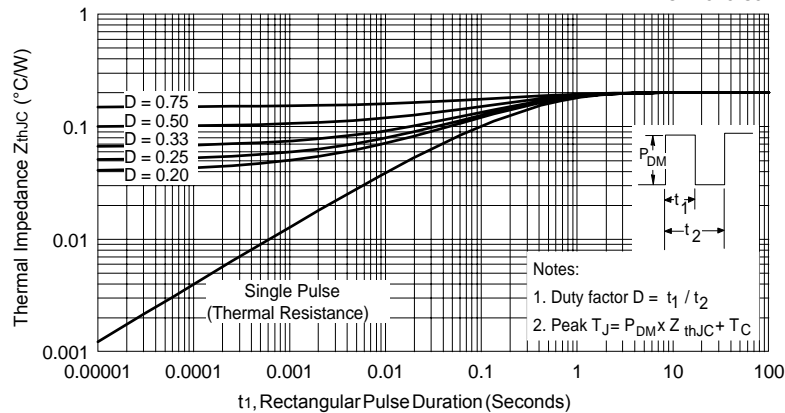

Fig. 4 - Max. Thermal Impedance  $Z_{thJC}$  Characteristics

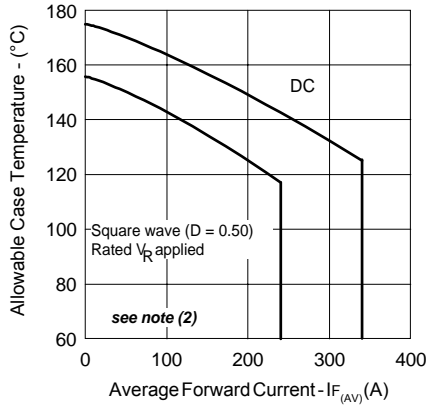

Fig. 5 - Max. Allowable Case Temperature Vs. Average Forward Current

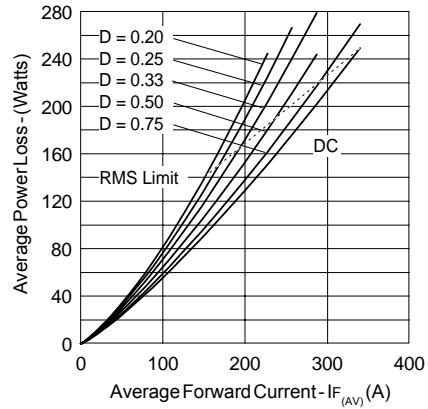

Fig. 6 - Forward Power Loss Characteristics

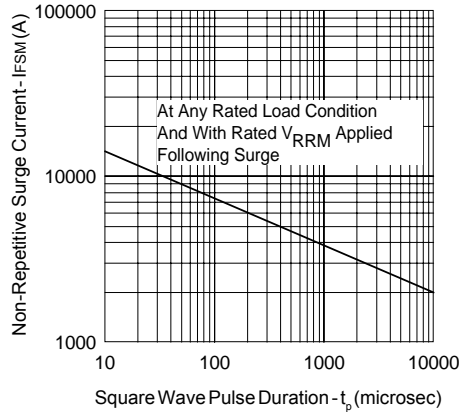

Fig. 7 - Max. Non-Repetitive Surge Current

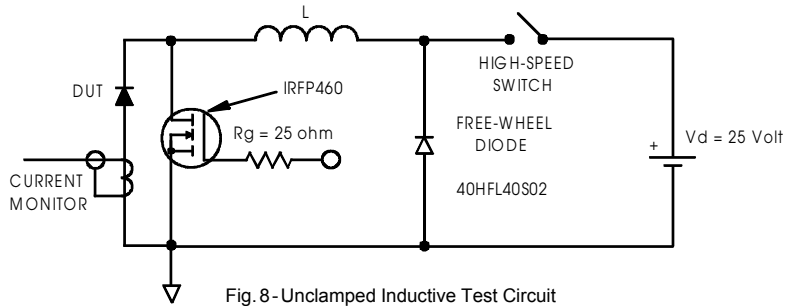

Fig. 8 - Unclamped Inductive Test Circuit

(2) Formula used:  $T_c = T_j - (P_d + P_{d_{REV}}) \times R_{thJC}$ ;

$P_d = \text{Forward Power Loss} = I_{F(AV)} \times V_{FM} @ (I_{F(AV)} / D)$  (see Fig. 6);

$P_{d_{REV}} = \text{Inverse Power Loss} = V_{R1} \times I_R (1 - D)$ ;  $I_R @ V_{R1} = \text{rated } V_R$

Data and specifications subject to change without notice.  
This product has been designed and qualified for Industrial Level.  
Qualification Standards can be found on IR's Web site.

International  
**IOR** Rectifier

**IR WORLD HEADQUARTERS:** 233 Kansas St., El Segundo, California 90245, USA Tel: (310) 252-7105  
TAC Fax: (310) 252-7309  
Visit us at [www.irf.com](http://www.irf.com) for sales contact information. 06/02