

# International IRF Rectifier

## 201CMQ... SERIES

### SCHOTTKY RECTIFIER

200 Amp

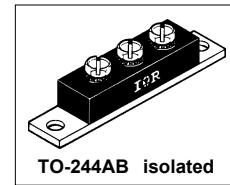

#### Major Ratings and Characteristics

Characteristics	201CMQ...	Units
$I_{F(AV)}$ Rectangular waveform	200	A
$V_{RRM}$	35 to 45	V
$I_{FSM}$ @tp=5µs sine	16,000	A
$V_F$ @100Apk, $T_J=125^\circ\text{C}$ (per leg)	0.58	V
$T_J$ range	-55 to 175	$^\circ\text{C}$

#### Description/Features

The 201CMQ high current Schottky rectifier module series has been optimized for low reverse leakage at high temperature.

The proprietary barrier technology allows for reliable operation up to 175 °C junction temperature. Typical applications are in high current switching power supplies, plating power supplies, UPS systems, converters, free-wheeling diodes, welding, and reverse battery protection.

- 175 °C  $T_J$  operation
- Center tap module - Isolated Base
- High purity, high temperature epoxy encapsulation for enhanced mechanical strength and moisture resistance
- Low forward voltage drop
- High frequency operation
- Guard ring for enhanced ruggedness and long term reliability

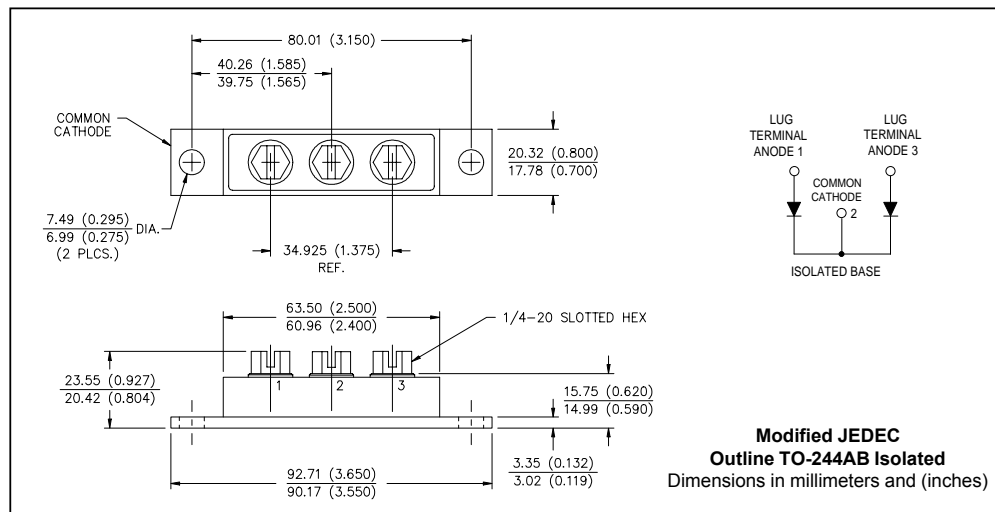

## 201CMQ... Series

Bulletin PD-2.400 rev. B 08/01

International  
IR Rectifier

### Voltage Ratings

Part number	201CMQ035	201CMQ040	201CMQ045
$V_R$ Max. DC Reverse Voltage (V)	35	40	45
$V_{RWM}$ Max. Working Peak Reverse Voltage (V)			

### Absolute Maximum Ratings

Parameters	201CMQ	Units	Conditions
$I_{F(AV)}$ Max. Average Forward Current (Per Leg) * See Fig. 5 (Per Device)	100 200	A	50% duty cycle @ $T_C = 121^\circ\text{C}$ , rectangular wave form
$I_{FSM}$ Max. Peak One Cycle Non-Repetitive Surge Current (Per Leg) * See Fig. 7	16,000 3200	A	5 $\mu\text{s}$ Sine or 3 $\mu\text{s}$ Rect. pulse 10ms Sine or 6ms Rect. pulse Following any rated load condition and with rated $V_{RWM}$ applied
$E_{AS}$ Non-Repetitive Avalanche Energy (Per Leg)	135	mJ	$T_J = 25^\circ\text{C}$ , $I_{AS} = 20$ Amps, $L = 0.67$ mH
$I_{AR}$ Repetitive Avalanche Current (Per Leg)	20	A	Current decaying linearly to zero in 1 $\mu\text{sec}$ Frequency limited by $T_J$ max. $V_A = 1.5 \times V_R$ typical

### Electrical Specifications

Parameters	201CMQ	Units	Conditions
$V_{FM}$ Max. Forward Voltage Drop (Per Leg) * See Fig. 1 (1)	0.67	V	@ 100A $T_J = 25^\circ\text{C}$
	0.81	V	@ 200A
	0.58	V	@ 100A $T_J = 125^\circ\text{C}$
	0.71	V	@ 200A
$I_{RM}$ Max. Reverse Leakage Current (Per Leg) * See Fig. 2 (1)	10	mA	$T_J = 25^\circ\text{C}$
	90	mA	$T_J = 125^\circ\text{C}$ $V_R = \text{rated } V_R$
$C_T$ Max. Junction Capacitance (Per Leg)	5200	pF	$V_R = 5V_{DC}$ , (test signal range 100Khz to 1Mhz) $25^\circ\text{C}$
$L_S$ Typical Series Inductance (Per Leg)	7.0	nH	From top of terminal hole to mounting plane
dv/dt Max. Voltage Rate of Change	10000	V/ $\mu\text{s}$	(Rated $V_R$ )
$V_{RMS}$ Insulation Voltage	1000	V	

(1) Pulse Width < 300 $\mu\text{s}$ , Duty Cycle < 2%

### Thermal-Mechanical Specifications

Parameters	201CMQ	Units	Conditions
$T_J$ Max. Junction Temperature Range	-55 to 175	$^\circ\text{C}$	
$T_{stg}$ Max. Storage Temperature Range	-55 to 175	$^\circ\text{C}$	
$R_{thJC}$ Max. Thermal Resistance Junction to Case (Per Leg)	0.70	$^\circ\text{C}/\text{W}$	DC operation * See Fig. 4
$R_{thJC}$ Max. Thermal Resistance Junction to Case (Per Package)	0.35	$^\circ\text{C}/\text{W}$	DC operation
$R_{thCS}$ Typical Thermal Resistance, Case to Heatsink	0.10	$^\circ\text{C}/\text{W}$	Mounting surface, smooth and greased
wt Approximate Weight	79 (2.80)	g (oz.)	
T Mounting Torque	Min.	24 (20)	Kg-cm (lbf-in)
	Max.	35 (30)	
	Typ.	13.5 (12)	
	Terminal Torque	Min. 35 (30) Max. 46 (40)	
Case Style	TO-244AB Isolated		Modified JEDEC

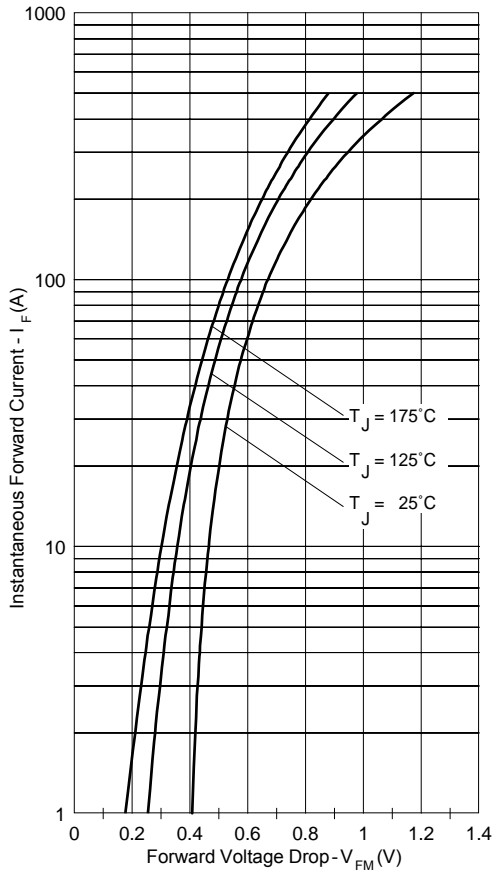

Fig. 1 - Max. Forward Voltage Drop Characteristics

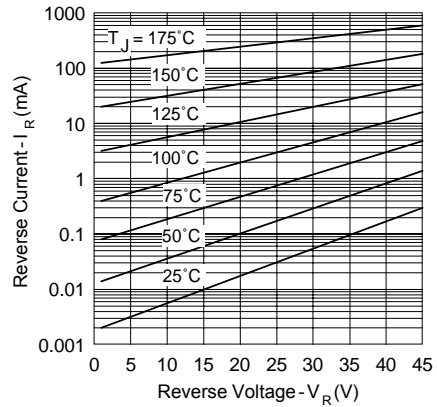

Fig. 2 - Typical Values Of Reverse Current Vs. Reverse Voltage

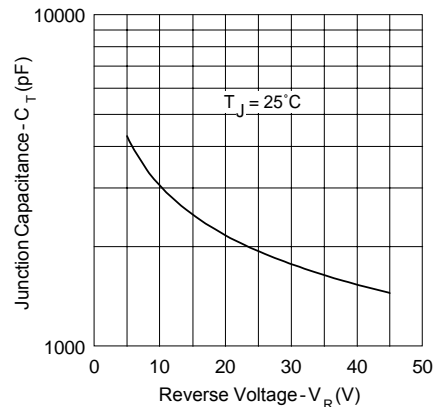

Fig. 3 - Typical Junction Capacitance Vs. Reverse Voltage

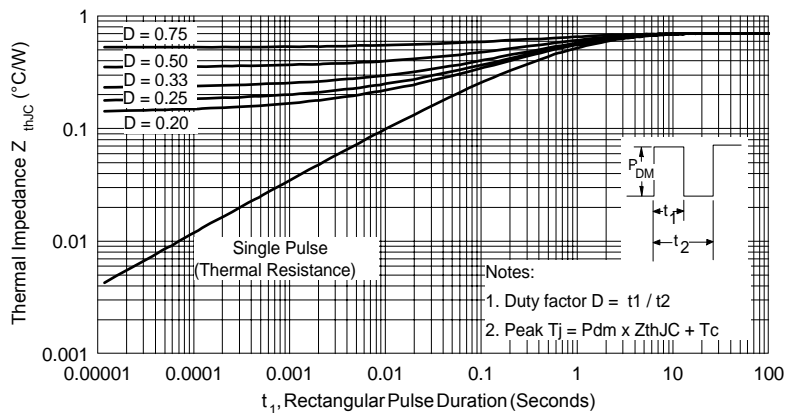
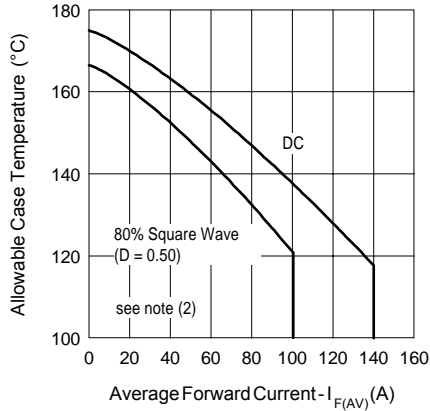
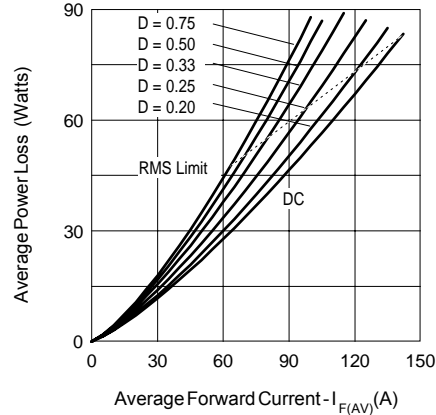

Fig. 4 - Max. Thermal Impedance  $Z_{thJC}$  Characteristics (Per Leg)



**Fig. 5 - Max. Allowable Case Temperature Vs. Average Forward Current**



**Fig. 6 - Forward Power Loss Characteristics**

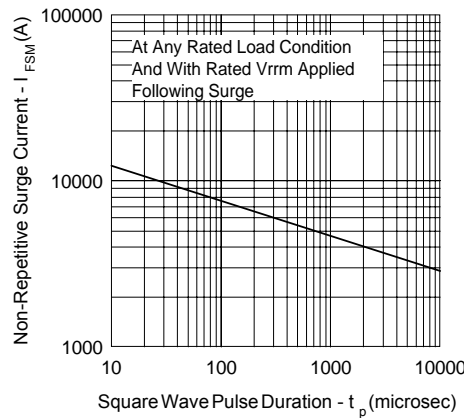

**Fig. 7 - Max. Non-Repetitive Surge Current**

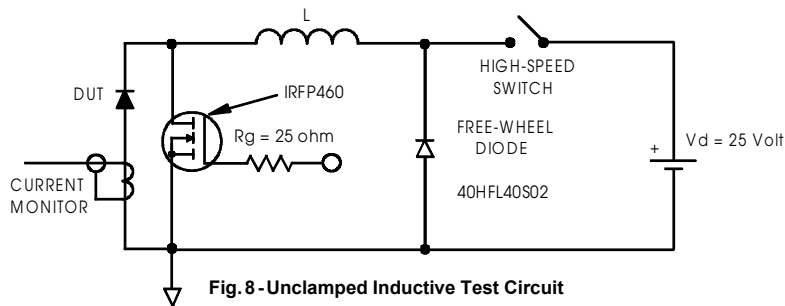

**Fig. 8 - Unclamped Inductive Test Circuit**

- (2) Formula used:  $T_C = T_J - (P_d + P_{d_{REV}}) \times R_{thJC}$ ;  
 $P_d = \text{Forward Power Loss} = I_{F(AV)} \times V_{FM} @ (I_{F(AV)} / D)$  (see Fig. 6);  
 $P_{d_{REV}} = \text{Inverse Power Loss} = V_{R1} \times I_{R1} (1 - D)$ ;  $I_{R1} @ V_{R1} = 80\%$  rated  $V_R$

Ordering Information Table

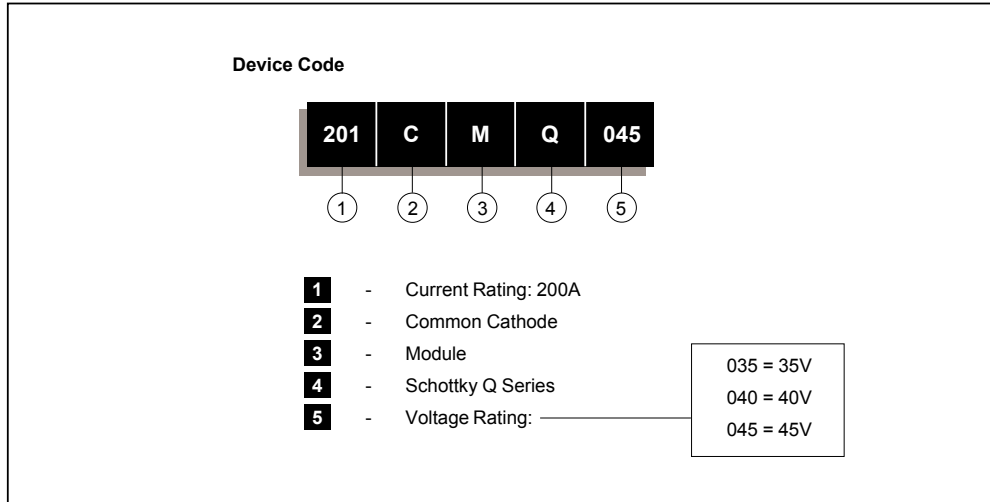

Data and specifications subject to change without notice.  
 This product has been designed and qualified for Industrial Level.  
 Qualification Standards can be found on IR's Web site.