

Powerex, Inc., 200 Hillis Street, Youngwood, Pennsylvania 15697-1800 (412) 925-7272
 Powerex, Europe, S.A. 428 Avenue G. Durand, BP107, 72003 Le Mans, France (43) 41.14.14

**General Purpose
Rectifier**
 2500 Amperes Average
 4200 Volts

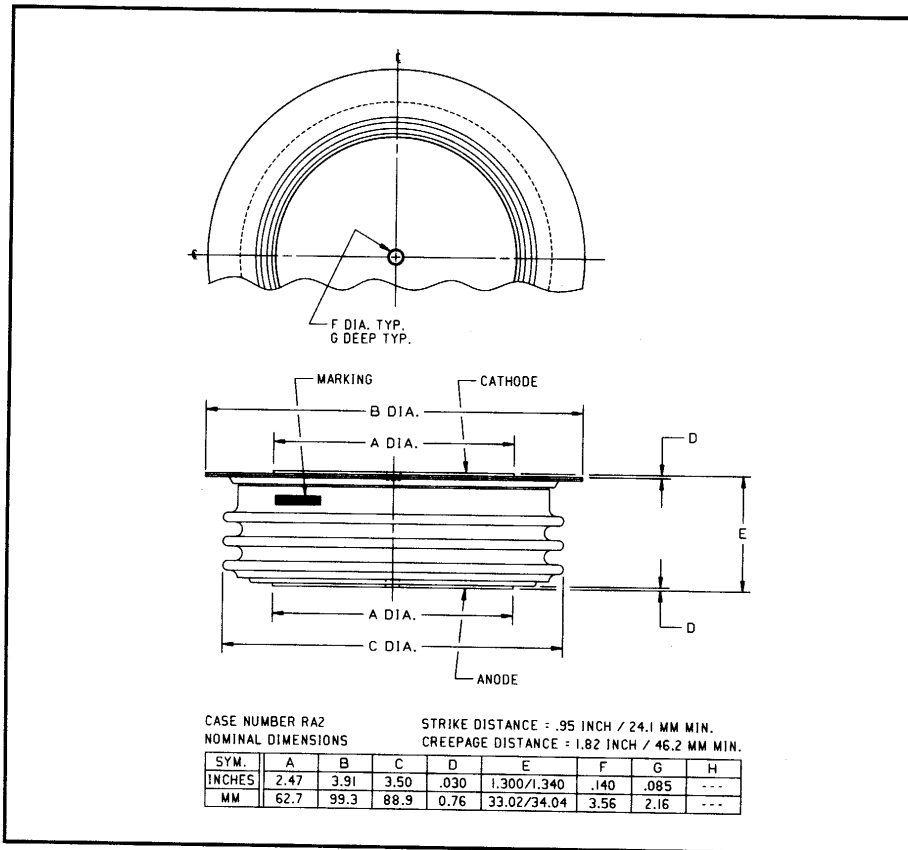

RA20 2500A (Outline Drawing)

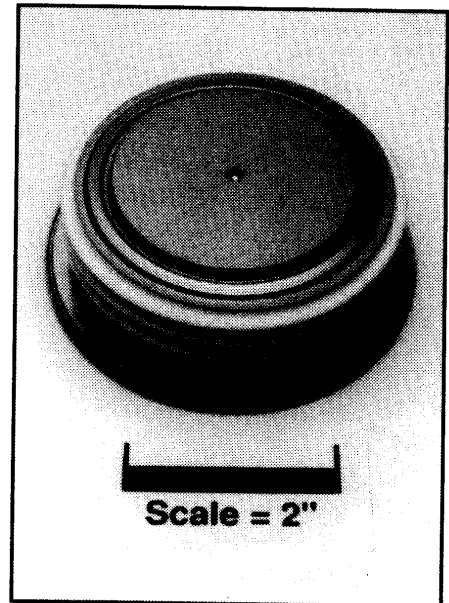

RA20 2500A General Purpose Rectifier
 2500 Amperes Average, 4200 Volts

Description:

Powerex General Purpose Rectifiers are designed for high blocking voltage capability with low forward voltage to minimize conduction losses. These hermetic Pow-R-Disc devices can be mounted using commercially available clamps and heatsinks.

Features:

- Low Forward Voltage
- Low Thermal Impedance
- Hermetic Packaging
- Excellent Surge and I^2t Ratings

Applications:

- Power Supplies
- Motor Control
- Free Wheeling Diode
- Battery Chargers
- Resistance Welding

Ordering Information:

Select the complete 8 digit part number you desire from the table below.

Type	Voltage	Current	Typical Recovery Time
	V_{RRM} (Volts)	$I_{T(av)}$ (A)	t_{rr} (μ sec)
RA20	10 through 42	25	XX
	1000V through 4200V	2500A	25 μ sec

Powerex, Inc., 200 Hillis Street, Youngwood, Pennsylvania 15697-1800 (412) 925-7272
 Powerex, Europe, S.A. 428 Avenue G. Durand, BP107, 72003 Le Mans, France (43) 41.14.14

RA20 2500A
General Purpose Rectifier
 2500 Amperes Average, 4200 Volts

Absolute Maximum Ratings

Characteristics	Symbol	RA20 2500A	Units
Non-repetitive Transient Peak Reverse Voltage	V_{RSM}	$V_{RRM} + 200V$	Volts
RMS Forward Current, $T_C = 100^\circ C$	$I_{F(rms)}$	3920	Amperes
Average Current 180° Sine Wave, $T_C = 100^\circ C$	$I_{F(av)}$	2500	Amperes
RMS Forward Current, $T_C = 55^\circ C$	$I_{F(rms)}$	5810	Amperes
Average Current 180° Sine Wave, $T_C = 55^\circ C$	$I_{F(av)}$	3700	Amperes
Peak One Cycle Surge Forward Current (Non-repetitive) 60Hz	I_{fsm}	28000	Amperes
Peak One Cycle Surge Forward Current (Non-repetitive) 50Hz	I_{fsm}	25500	Amperes
3 Cycle Surge Current	I_{fsm}	22400	Amperes
10 Cycle Surge Current	I_{fsm}	17500	Amperes
I^2t (for Fusing) for One Cycle, 60Hz	I^2t	3.20×10^6	A^2sec
Maximum I^2t of Package ($t = 8.3$ msec)	I^2t	125×10^6	A^2sec
Operating Temperature	T_j	-40 to +150°C	°C
Storage Temperature	T_{stg}	-40 to +200°C	°C
Approximate Weight		2.1	lb.
		950	g
Mounting Force		9000 to 11000	lb.
		4100 to 5000	kg.

RA20 2500A
General Purpose Rectifier
 2500 Amperes Average, 4200 Volts

Electrical Characteristics, $T_j = 25^\circ\text{C}$ Unless Otherwise Specified

Characteristics	Symbol	Test Conditions	Min.	Typ.	Max.	Units
Peak Reverse Leakage Current	I_{RRM}	$T_j = 125^\circ\text{C}, V_R = V_{RRM}$			200	mA
Forward Voltage Drop	V_{FM}	$I_{FM} = 3000\text{A}, \text{Duty Cycle} < 0.1\%$			1.25	Volts
Threshold Voltage, Low-level	$V_{(TO)1}$	$T_j = 150^\circ\text{C}, I = 15\%, I_{T(av)}$ to $\pi I_{T(av)}$			0.74116	Volts
Slope Resistance, Low-level	r_{T1}				0.1320	m Ω
Threshold Voltage, High-level	$V_{(TO)2}$	$T_j = 150^\circ\text{C}, I = \pi I_{T(av)}$ to I_{TSM}			0.84047	Volts
Slope Resistance, High-level	r_{T2}				0.1194	m Ω
V_{TM} Coefficients, Low-level		$T_j = 150^\circ\text{C}, I = 15\% I_{T(av)}$ to $\pi I_{T(av)}$				
					$A_1 = 0.49905$	
					$B_1 = 0.05116$	
					$C_1 = 1.483\text{E-}04$	
					$D_1 = -0.00392$	
V_{TM} Coefficients, High-level		$T_j = 150^\circ\text{C}, I = \pi I_{T(av)}$ to I_{TSM}				
					$A_2 = -5.3652$	
					$B_2 = 0.86841$	
					$C_2 = 1.378\text{E-}04$	
					$D_2 = -0.01944$	
Typical Reverse Recovery Time	t_{rr}	$T_C = 25^\circ\text{C}, I_{FM} = 1500\text{A},$ $di_R/dt = 25\text{A}/\mu\text{sec}, t_p = 190\mu\text{sec}$		25		μsec
Thermal Characteristics						
Maximum Thermal Resistance, Double Sided Cooling						
Junction-to-Case	$R_{\theta(j-c)}$				0.013	$^\circ\text{C/W}$
Case-to-Sink	$R_{\theta(c-s)}$				0.007	$^\circ\text{C/W}$

Powerex, Inc., 200 Hillis Street, Youngwood, Pennsylvania 15697-1800 (412) 925-7272
 Powerex, Europe, S.A. 428 Avenue G. Durand, BP107, 72003 Le Mans, France (43) 41.14.14

RA20 2500A
 General Purpose Rectifier
 2500 Amperes Average, 4200 Volts

Maximum On-State Forward Voltage Drop
 ($T_J = 150^\circ\text{C}$)

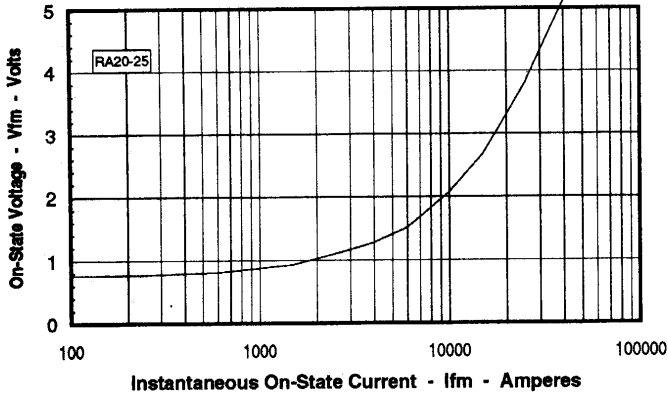

Maximum Transient Thermal Impedance
 (Junction to Case)

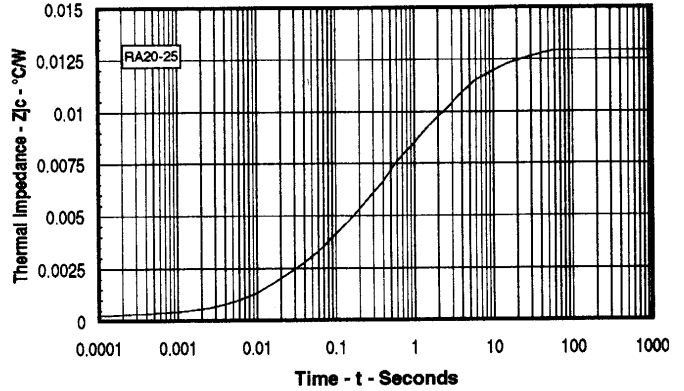

Maximum On-State Power Dissipation
 (Sinusoidal Waveform)

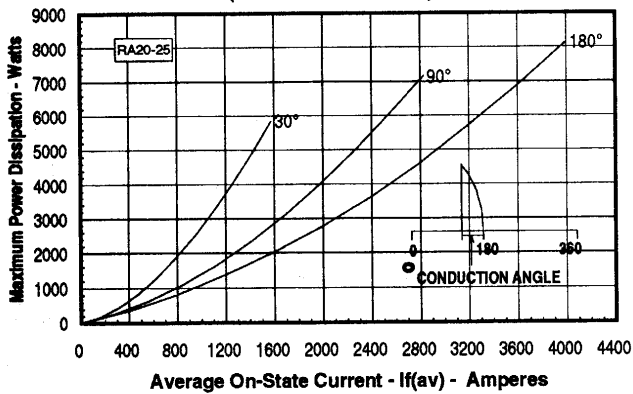

Maximum Allowable Case Temperature
 (Sinusoidal Waveform)

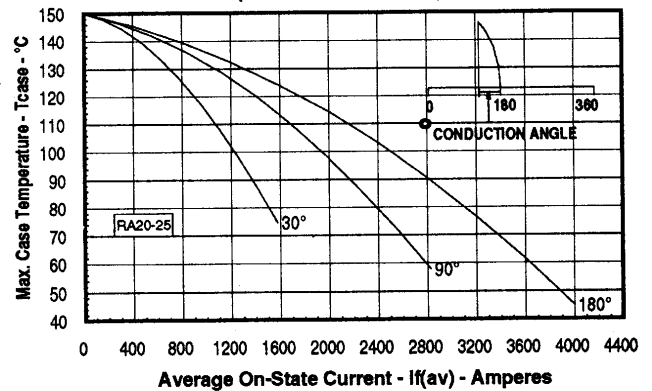

Maximum On-State Power Dissipation
 (Rectangular Waveform)

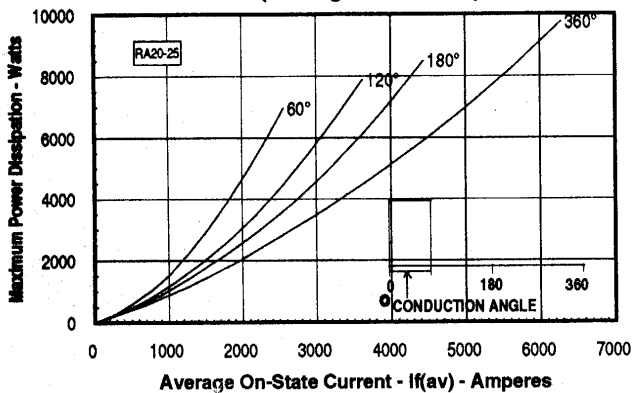

Maximum Allowable Case Temperature
 (Rectangular Waveform)

