

Fast Recovery Epitaxial Diode (FRED) Module

MEA 75-12 DA
MEK 75-12 DA
MEE 75-12 DA

V_{RRM} = 1200 V
I_{FAV} = 75 A
t_{rr} = 250 ns

Preliminary data

V _{RSM} V	V _{RRM} V	Type						
1200	1200	<table border="0"> <tr> <td>MEA75-12 DA</td> <td>MEK 75-12 DA</td> <td>MEE 75-12 DA</td> </tr> <tr> <td></td> <td></td> <td></td> </tr> </table>	MEA75-12 DA	MEK 75-12 DA	MEE 75-12 DA			
MEA75-12 DA	MEK 75-12 DA	MEE 75-12 DA						

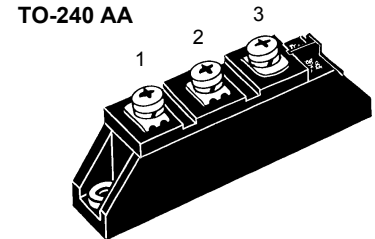

Symbol	Test Conditions	Maximum Ratings
I _{FRMS}	T _{case} = 75 °C	107 A
I _{FAV}	T _{case} = 75 °C; rectangular, d = 0.5	75 A
I _{FRM}	t _p < 10 μs; rep. rating, pulse width limited by T _{VJM}	TBD A
I _{FSM}	T _{VJ} = 45°C; t = 10 ms (50 Hz), sine	1200 A
	t = 8.3 ms (60 Hz), sine	1300 A
I ² t	T _{VJ} = 150°C; t = 10 ms (50 Hz), sine	1080 A
	t = 8.3 ms (60 Hz), sine	1170 A
I ² t	T _{VJ} = 45°C; t = 10 ms (50 Hz), sine	7200 A ² s
	t = 8.3 ms (60 Hz), sine	7100 A ² s
I ² t	T _{VJ} = 150°C; t = 10 ms (50 Hz), sine	5800 A ² s
	t = 8.3 ms (60 Hz), sine	5700 A ² s
T _{VJ}		-40...+150 °C
T _{stg}		-40...+125 °C
T _{Hmax}		110 °C
P _{tot}	T _{case} = 25°C	280 W
V _{ISOL}	50/60 Hz, RMS t = 1 min	3000 V~
	I _{ISOL} ≤ 1 mA t = 1 s	3600 V~
M _d	Mounting torque (M5)	2.50-4/22-35 Nm/lb.in.
	Terminal connection torque (M5)	2.50-4/22-35 Nm/lb.in.
d _s	Creep distance on surface	12.7 mm
d _A	Strike distance through air	9.6 mm
a	Maximum allowable acceleration	50 m/s ²
Weight		90 g

Features

- International standard package with DCB ceramic base plate
- Planar passivated chips
- Short recovery time
- Low switching losses
- Soft recovery behaviour
- Isolation voltage 3600 V~
- UL registered E 72873

Applications

- Antiparallel diode for high frequency switching devices
- Free wheeling diode in converters and motor control circuits
- Inductive heating and melting
- Uninterruptible power supplies (UPS)
- Ultrasonic cleaners and welders

Advantages

- High reliability circuit operation
- Low voltage peaks for reduced protection circuits
- Low noise switching
- Low losses

Symbol	Test Conditions	Characteristic Values (per diode)		
		typ.	max.	
I _R	T _{VJ} = 25°C V _R = V _{RRM}		2 mA	
	T _{VJ} = 25°C V _R = 0.8 • V _{RRM}		0.5 mA	
	T _{VJ} = 125°C V _R = 0.8 • V _{RRM}		34 mA	
V _F	I _F = 100A; T _{VJ} = 125°C		1.85 V	
	T _{VJ} = 25°C		2.17 V	
	I _F = 300A; T _{VJ} = 125°C		2.58 V	
	T _{VJ} = 25°C		2.64 V	
V _{T0}	For power-loss calculations only		1.48 V	
r _T			3.65 mΩ	
R _{thJH}	DC current		0.550 K/W	
R _{thJC}	DC current		0.450 K/W	
t _{rr} } I _{RM} }	I _F = 150 A V _R = 600 V -di/dt = 200 A/μs	250	T _{VJ} = 100°C	300 ns
			T _{VJ} = 25°C	22 A
			T _{VJ} = 100°C	33 A

Dimensions in mm (1 mm = 0.0394")

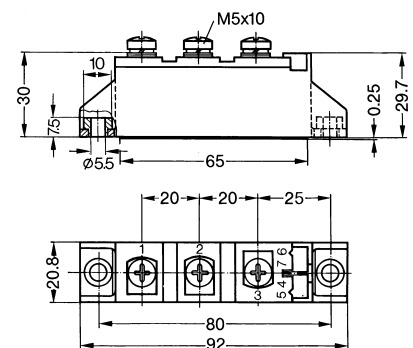

Data according to IEC 60747
IXYS reserves the right to change limits, test conditions and dimensions

© 2000 IXYS All rights reserved

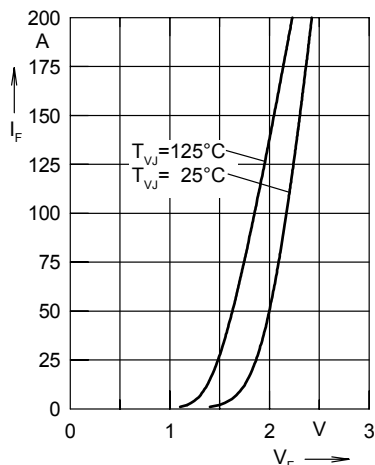

Fig. 1 Forward current I_F versus voltage drop V_F per leg

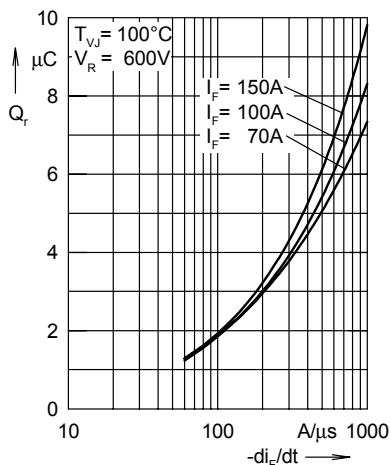

Fig. 2 Reverse recovery charge Q_r versus $-di_F/dt$

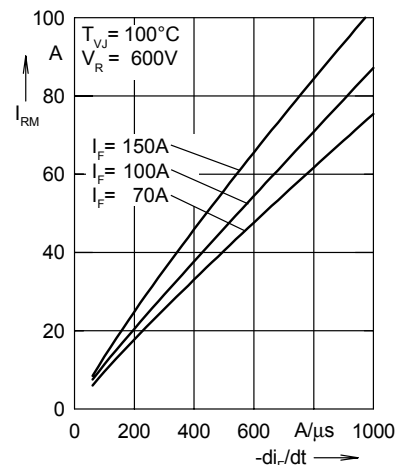

Fig. 3 Peak reverse current I_{RM} versus $-di_F/dt$

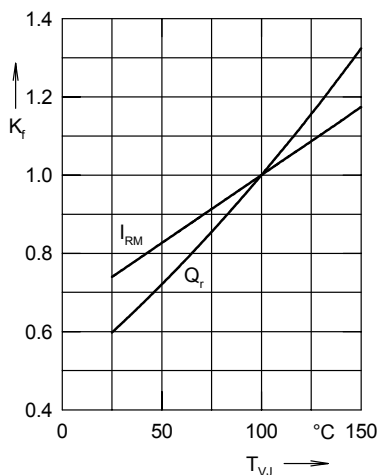

Fig. 4 Dynamic parameters Q_r , I_{RM} versus junction temperature T_{VJ}

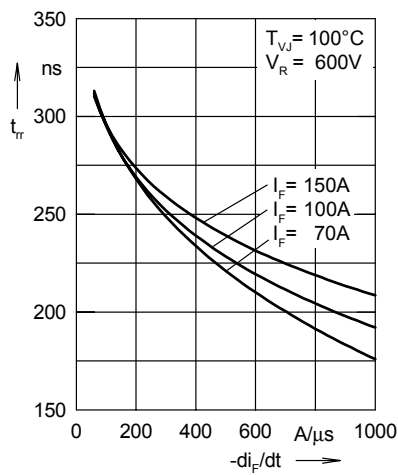

Fig. 5 Recovery time t_{tr} versus $-di_F/dt$

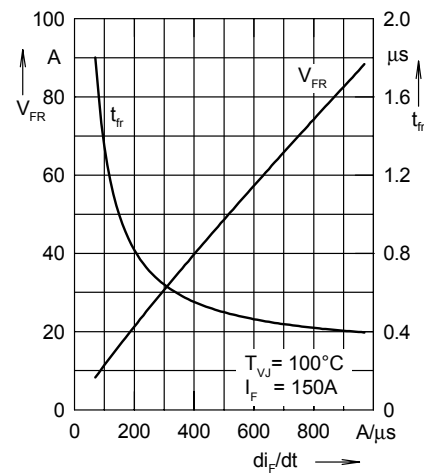

Fig. 6 Peak forward voltage V_{FR} and t_{tr} versus di_F/dt

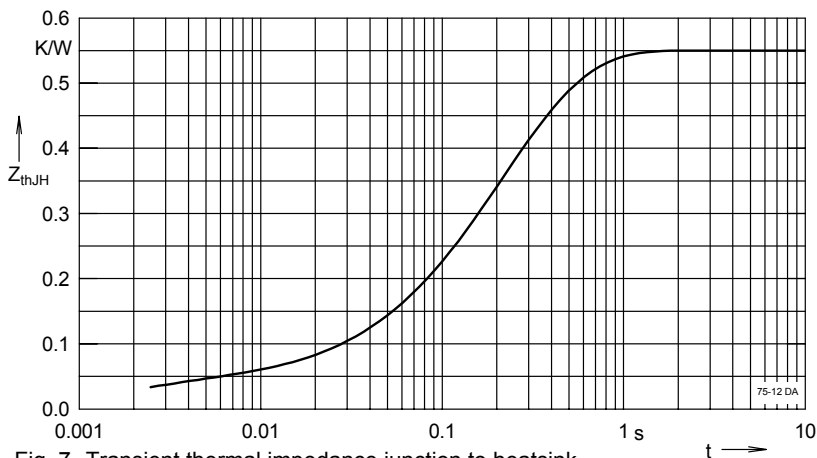

Fig. 7 Transient thermal impedance junction to heatsink

Constants for Z_{thJH} calculation:

i	R_{thi} (K/W)	t_i (s)
1	0.037	0.002
2	0.138	0.134
3	0.093	0.25
4	0.282	0.274