

## Ultrafast recovery diode

### Main product characteristics

$I_{F(AV)}$	2 x 50 A
$V_{RRM}$	200 V
$T_j$ (max)	150° C
$V_F$ (typ)	0.72 V
$t_{rr}$ (typ)	30 ns

### Features and benefits

- Very low forward losses
- Low recovery time
- High surge current capability
- Insulated
  - Insulating voltage = 2500 V<sub>rms</sub>
  - Capacitance = 45 pF

### Description

The STTH10002 is a dual rectifier suited for welding equipment, and high power industrial applications.

Packaged in ISOTOP, this device is intended for use in the secondary rectification of power converters.

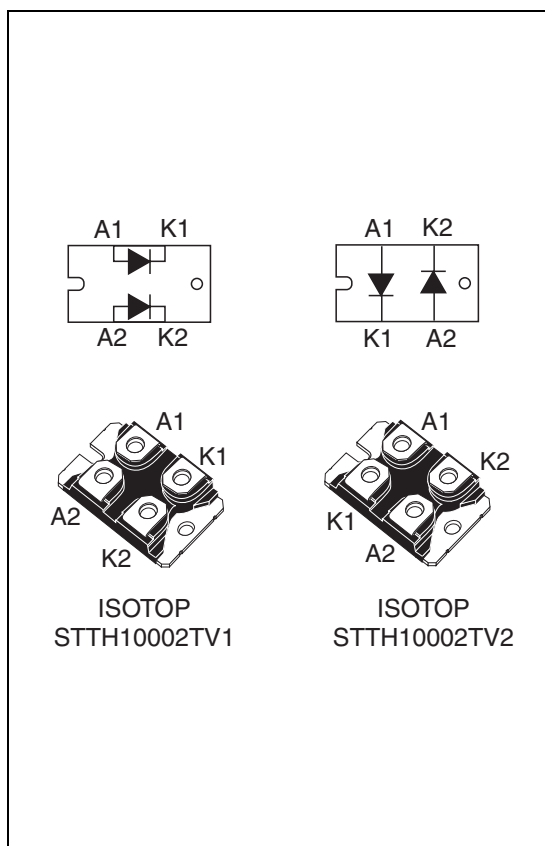

### Order codes

Part Number	Marking
STTH10002TV1	STTH10002TV1
STTH10002TV2	STTH10002TV2

# 1 Characteristics

**Table 1. Absolute ratings (limiting values at  $T_j = 25^\circ\text{C}$ , unless otherwise specified)**

Symbol	Parameter		Value	Unit
$V_{RRM}$	Repetitive peak reverse voltage		200	V
$I_{F(RMS)}$	RMS forward current	Per diode	150	A
$I_{F(AV)}$	Average forward current, $\delta = 0.5$	Per diode $T_c = 100^\circ\text{C}$	50	A
		Per device $T_c = 95^\circ\text{C}$		
$I_{FSM}$	Surge non repetitive forward current	$t_p = 10\text{ ms}$ Sinusoidal	750	A
$T_{stg}$	Storage temperature range		-55 to + 175	$^\circ\text{C}$
$T_j$	Maximum operating junction temperature		150	$^\circ\text{C}$

**Table 2. Thermal parameters**

Symbol	Parameter		Value	Unit
$R_{th(j-c)}$	Junction to case	Per diode	1	$^\circ\text{C/W}$
		Total	0.55	
$R_{th(c)}$	Coupling		0.1	

When the two diodes 1 and 2 are used simultaneously:

$$\Delta T_j(\text{diode } 1) = P(\text{diode } 1) \times R_{th(j-c)} (\text{Per diode}) + P(\text{diode } 2) \times R_{th(c)}$$

**Table 3. Static electrical characteristics**

Symbol	Parameter	Test conditions		Min.	Typ	Max.	Unit
$I_R^{(1)}$	Reverse leakage current	$T_j = 25^\circ\text{C}$	$V_R = V_{RRM}$			50	$\mu\text{A}$
		$T_j = 125^\circ\text{C}$			50	500	
$V_F^{(2)}$	Forward voltage drop	$T_j = 25^\circ\text{C}$	$I_F = 50\text{ A}$			1	V
			$I_F = 100\text{ A}$			1.15	
		$T_j = 125^\circ\text{C}$	$I_F = 100\text{ A}$		0.90	1.0	
			$I_F = 50\text{ A}$		0.72	0.80	
$T_j = 150^\circ\text{C}$	$I_F = 50\text{ A}$		0.86	0.97			
	$I_F = 100\text{ A}$						

1. Pulse test:  $t_p = 5\text{ ms}$ ,  $\delta < 2\%$

2. Pulse test:  $t_p = 380\text{ }\mu\text{s}$ ,  $\delta < 2\%$

To evaluate the conduction losses use the following equation:

$$P = 0.63 \times I_{F(AV)} + 0.0034 I_{F(RMS)}^2$$

Table 4. Dynamic characteristics

Symbol	Parameter	Test conditions	Min.	Typ	Max.	Unit
$t_{rr}$	Reverse recovery time	$I_F = 1 \text{ A}$ , $dI_F/dt = -50 \text{ A}/\mu\text{s}$ , $V_R = 30 \text{ V}$ , $T_j = 25 \text{ }^\circ\text{C}$		53	65	ns
		$I_F = 1 \text{ A}$ , $dI_F/dt = -200 \text{ A}/\mu\text{s}$ , $V_R = 30 \text{ V}$ , $T_j = 25 \text{ }^\circ\text{C}$		30	37	
$I_{RM}$	Reverse recovery current	$I_F = 50 \text{ A}$ , $dI_F/dt = 200 \text{ A}/\mu\text{s}$ , $V_R = 160 \text{ V}$ , $T_j = 125 \text{ }^\circ\text{C}$		10	13	A
$t_{fr}$	Forward recovery time	$I_F = 50 \text{ A}$ , $dI_F/dt = 200 \text{ A}/\mu\text{s}$ $V_{FR} = 1.1 \times V_{Fmax}$ , $T_j = 25 \text{ }^\circ\text{C}$		180		ns
$V_{FP}$	Forward recovery voltage	$I_F = 50 \text{ A}$ , $dI_F/dt = 200 \text{ A}/\mu\text{s}$ , $T_j = 25 \text{ }^\circ\text{C}$		1.6		V

Figure 1. Peak current versus duty cycle

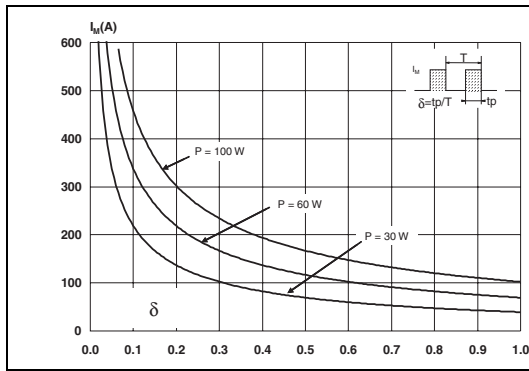

Figure 2. Forward voltage drop versus forward current (typical values, per diode)

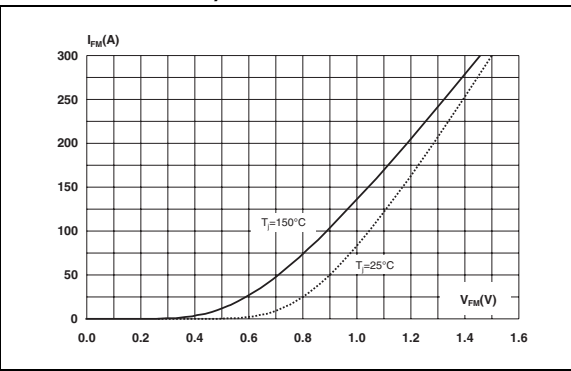

Figure 3. Forward voltage drop versus forward current (maximum values, per diode)

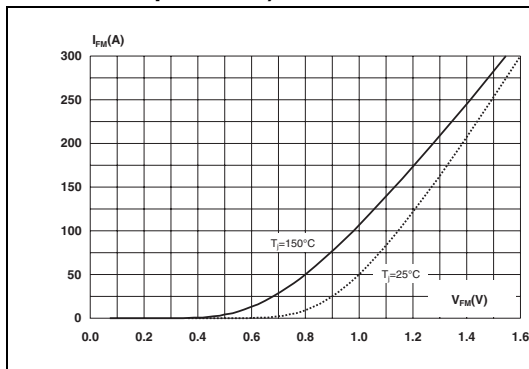
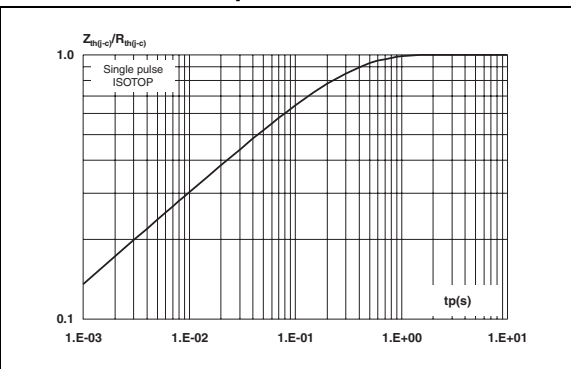
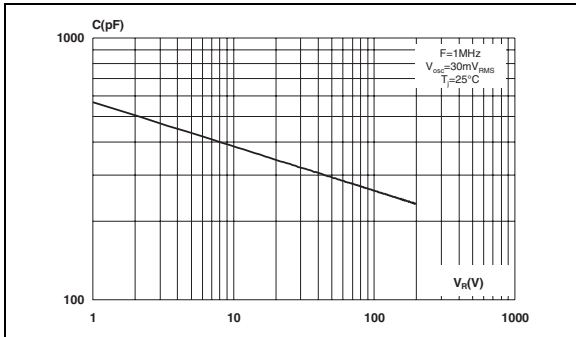

Figure 4. Relative variation of thermal impedance, junction to case, versus pulse duration



**Figure 5. Junction capacitance versus reverse applied voltage (typical values)**



**Figure 6. Reverse recovery charges versus  $di_F/dt$  (typical values)**

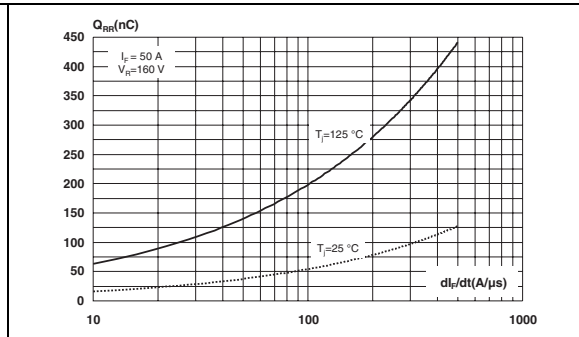

**Figure 7. Reverse recovery time versus  $di_F/dt$  (typical values)**

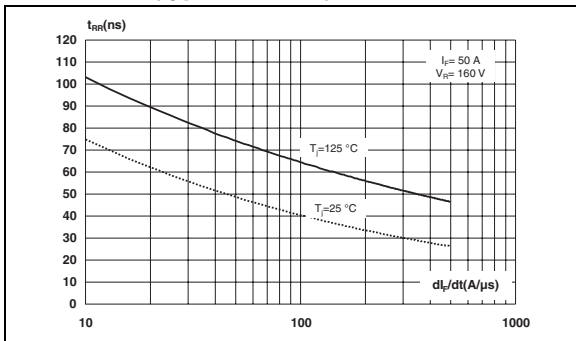

**Figure 8. Peak reverse recovery current versus  $di_F/dt$  (typical values)**

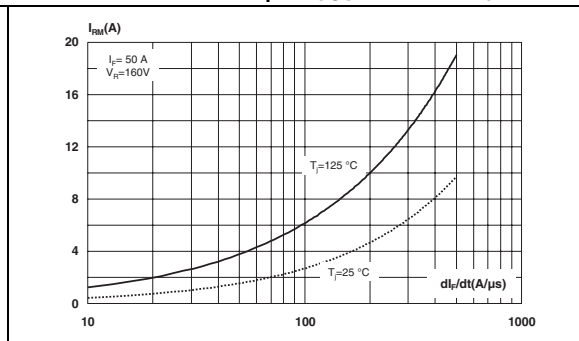

**Figure 9. Dynamic parameters versus junction temperature**

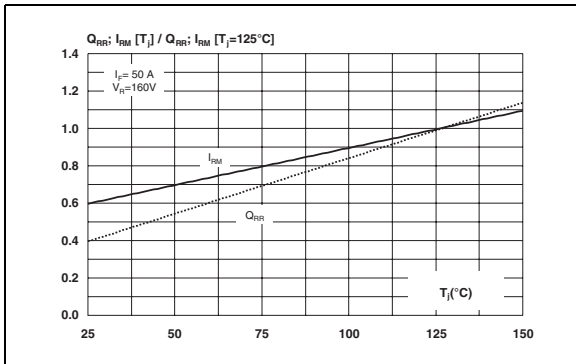

## 2 Ordering information scheme

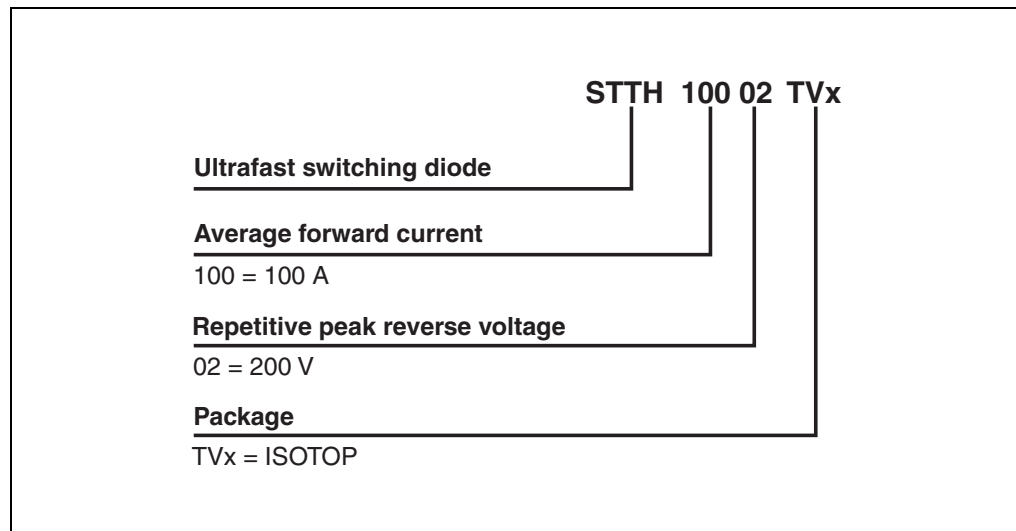

### 3 Package information

Table 5. ISOTOP dimensions

REF.	DIMENSIONS			
	Millimeters		Inches	
	Min.	Max.	Min.	Max.
A	11.80	12.20	0.465	0.480
A1	8.90	9.10	0.350	0.358
B	7.8	8.20	0.307	0.323
C	0.75	0.85	0.030	0.033
C2	1.95	2.05	0.077	0.081
D	37.80	38.20	1.488	1.504
D1	31.50	31.70	1.240	1.248
E	25.15	25.50	0.990	1.004
E1	23.85	24.15	0.939	0.951
E2	24.80 typ.		0.976 typ.	
G	14.90	15.10	0.587	0.594
G1	12.60	12.80	0.496	0.504
G2	3.50	4.30	0.138	0.169
F	4.10	4.30	0.161	0.169
F1	4.60	5.00	0.181	0.197
P	4.00	4.30	0.157	0.69
P1	4.00	4.40	0.157	0.173
S	30.10	30.30	1.185	1.193

In order to meet environmental requirements, ST offers these devices in ECOPACK® packages. These packages have a lead-free second level interconnect. The category of second level interconnect is marked on the package and on the inner box label, in compliance with JEDEC Standard JESD97. The maximum ratings related to soldering conditions are also marked on the inner box label. ECOPACK is an ST trademark. ECOPACK specifications are available at: [www.st.com](http://www.st.com).

## 4 Ordering information

Part Number	Marking	Package	Weight	Base qty	Delivery mode
STTH10002TV1	STTH10002TV1	ISOTOP	27 g	10	Tube
STTH10002TV2	STTH10002TV2	ISOTOP	27 g	10	Tube

## 5 Revision history

Date	Revision	Description of Changes
05-Apr-2006	1	First issue

Please Read Carefully:

Information in this document is provided solely in connection with ST products. STMicroelectronics NV and its subsidiaries ("ST") reserve the right to make changes, corrections, modifications or improvements, to this document, and the products and services described herein at any time, without notice.

All ST products are sold pursuant to ST's terms and conditions of sale.

Purchasers are solely responsible for the choice, selection and use of the ST products and services described herein, and ST assumes no liability whatsoever relating to the choice, selection or use of the ST products and services described herein.

No license, express or implied, by estoppel or otherwise, to any intellectual property rights is granted under this document. If any part of this document refers to any third party products or services it shall not be deemed a license grant by ST for the use of such third party products or services, or any intellectual property contained therein or considered as a warranty covering the use in any manner whatsoever of such third party products or services or any intellectual property contained therein.

**UNLESS OTHERWISE SET FORTH IN ST'S TERMS AND CONDITIONS OF SALE ST DISCLAIMS ANY EXPRESS OR IMPLIED WARRANTY WITH RESPECT TO THE USE AND/OR SALE OF ST PRODUCTS INCLUDING WITHOUT LIMITATION IMPLIED WARRANTIES OF MERCHANTABILITY, FITNESS FOR A PARTICULAR PURPOSE (AND THEIR EQUIVALENTS UNDER THE LAWS OF ANY JURISDICTION), OR INFRINGEMENT OF ANY PATENT, COPYRIGHT OR OTHER INTELLECTUAL PROPERTY RIGHT.**

**UNLESS EXPRESSLY APPROVED IN WRITING BY AN AUTHORIZED REPRESENTATIVE OF ST, ST PRODUCTS ARE NOT DESIGNED, AUTHORIZED OR WARRANTED FOR USE IN MILITARY, AIR CRAFT, SPACE, LIFE SAVING, OR LIFE SUSTAINING APPLICATIONS, NOR IN PRODUCTS OR SYSTEMS, WHERE FAILURE OR MALFUNCTION MAY RESULT IN PERSONAL INJURY, DEATH, OR SEVERE PROPERTY OR ENVIRONMENTAL DAMAGE.**

Resale of ST products with provisions different from the statements and/or technical features set forth in this document shall immediately void any warranty granted by ST for the ST product or service described herein and shall not create or extend in any manner whatsoever, any liability of ST.

ST and the ST logo are trademarks or registered trademarks of ST in various countries.

Information in this document supersedes and replaces all information previously supplied.

The ST logo is a registered trademark of STMicroelectronics. All other names are the property of their respective owners.

© 2006 STMicroelectronics - All rights reserved

STMicroelectronics group of companies

Australia - Belgium - Brazil - Canada - China - Czech Republic - Finland - France - Germany - Hong Kong - India - Israel - Italy - Japan - Malaysia - Malta - Morocco - Singapore - Spain - Sweden - Switzerland - United Kingdom - United States of America

[www.st.com](http://www.st.com)