

CONFIDENTIAL & PROPRIETARY

THIS INFORMATION IS CONFIDENTIAL AND PROPRIETARY TO LAIRD TECHNOLOGIES. IT MAY NOT BE DISCLOSED TO ANYONE, OTHER THAN LAIRD TECHNOLOGIES PERSONNEL, WITHOUT WRITTEN AUTHORIZATION FROM LAIRD TECHNOLOGIES.

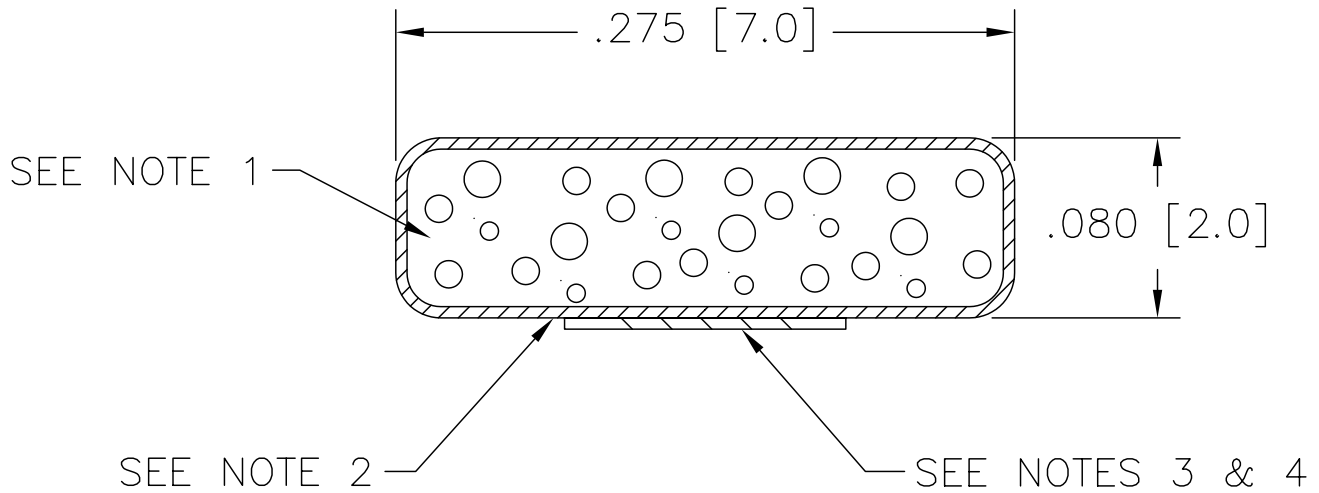

NOTES:

1. FOAM: POLYURETHANE
2. FABRIC: NICKEL PET-TAF FR Ecogreen
3. TAPE: .125" TAPE HI-TEMP
4. LINER: NO EXTENDED RELEASE LINER
5. FABRIC SEAM LOCATION MAY VARY.
6. CARRIER: NO CARRIER
7. THIS PART IS RoHS COMPLIANT

REVISIONS: 1. TAPE WAS .100" - P08-006 - 1/21/08 FJG	TITLE:		DRAWN	DATE	SCALE:	DIMENSIONS ARE IN INCHES. UNLESS OTHERWISE SPECIFIED, TOLERANCES ARE AS FOLLOWS:
	SHIELDING GASKET		GIBILTERRA	10/02/07	1/1	
	Dwg. or Part No.	REV.	CHECKED BY:	DATE		DECIMALS
	4096-PA-51H	1	FJG	10/02/07		LENGTH
			RELEASED BY:	DATE		ANGLES
			FJG	10/02/07		± .030"
						± .050"
						± .100"
						± .187"
						± .250"

