



RXD-315-KH2
 RXD-418-KH2
 RXD-433-KH2



KH2 SERIES RECEIVER / DECODER DATA GUIDE

DESCRIPTION

The KH2 Series is ideally suited for volume use in OEM applications such as remote control / command and keyless entry. It combines a high-performance RF receiver with an on-board decoder. When paired with a matching KH Series transmitter / encoder module, OEM transmitter, or LC or LR Series transmitter and Holtek HT640 encoder combination, a highly reliable wireless link is formed, capable of transferring the status of 8 parallel inputs for distances of up to 3,000 feet. Ten tri-state address lines provide 59,049 (3¹⁰) different addresses for security and uniqueness. Housed in a compact SMD package, the KH2 module utilizes an advanced synthesized architecture to achieve an unmatched blend of performance, size, range, and cost. No external RF components, are required (except an antenna), making design integration straightforward.

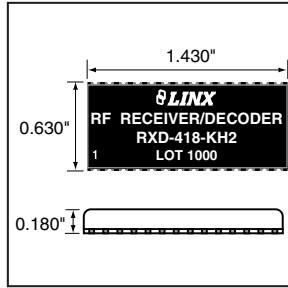

Figure 1: Package Dimensions

FEATURES

- Low cost
- Long Range
- On-board decoder
- 8 parallel binary outputs
- 3¹⁰ addresses for security and uniqueness
- Ultra-low power consumption
- Compact SMD package
- Advanced synthesized architecture
- Received data output
- Transmission validation
- No production tuning
- No external RF components required (except an antenna)
- Pin-compatible with original KH

APPLICATIONS INCLUDE

- Remote Control / Command
- Keyless Entry
- Garage / Gate Openers
- Lighting Control
- Call Systems
- Home / Industrial Automation
- Fire / Security Alarms
- Remote Status Monitoring
- Wire Elimination

ORDERING INFORMATION

PART #	DESCRIPTION
TXE-315-KH	Transmitter / Encoder 315MHz
TXE-418-KH	Transmitter / Encoder 418MHz
TXE-433-KH	Transmitter / Encoder 433MHz
RXD-315-KH2	Receiver / Decoder 315MHz
RXD-418-KH2	Receiver / Decoder 418MHz
RXD-433-KH2	Receiver / Decoder 433MHz
EVAL-***-KH2	Basic Evaluation Kit

*** = Frequency

Receivers are supplied in tubes of 20 pcs.

Revised 1/28/08

ELECTRICAL SPECIFICATIONS

Parameter	Designation	Min.	Typical	Max.	Units	Notes
POWER SUPPLY						
Operating Voltage	V_{CC}	2.7	3.0	3.6	VDC	–
With Dropping Resistor		4.3	5.0	5.2	VDC	1,5
Supply Current	I_{CC}	4.0	5.2	7.0	mA	–
Power-Down Current	I_{PDN}	20.0	28.0	35.0	μ A	5
RECEIVER SECTION						
Receive Frequency Range:	F_C	–	315	–	MHz	–
RXD-315-KH2		–	418	–	MHz	–
RXD-418-KH2		–	433.92	–	MHz	–
RXD-433-KH2		–	–	–	MHz	–
Center Frequency Accuracy	–	-50	–	+50	kHz	–
LO Feedthrough	–	–	-80	–	dBm	2,5
IF Frequency	F_{IF}	–	10.7	–	MHz	5
Noise Bandwidth	N_{3dB}	–	280	–	kHz	–
Data Rate	–	100	–	10,000	bps	–
Data Output:						
Logic Low	V_{OL}	–	0.0	–	VDC	3
Logic High	V_{OH}	–	3.0	–	VDC	3
Power-Down Input:						
Logic Low	V_{IL}	–	–	0.4	VDC	–
Logic High	V_{IH}	$V_{CC}-0.4$	–	–	VDC	–
Receiver Sensitivity	–	-106	-112	-118	dBm	4
RSSI / Analog:						
Dynamic Range	–	–	80	–	dB	5
Analog Bandwidth	–	50	–	5,000	Hz	5
Gain	–	–	16	–	mV / dB	5
Voltage With No Carrier	–	–	1.5	–	V	5
ANTENNA PORT						
RF Input Impedance	R_{IN}	–	50	–	Ω	5
TIMING						
Receiver Turn-On Time:						
Via V_{CC}	–	3.0	7.0	10.0	mSec	5,6
Via PDN	–	0.04	0.25	0.50	mSec	5,6
Max. Time Between Transitions	–	–	10.0	–	mSec	5
DECODER SECTION						
TX Data Length	–	–	26 bits 3x	–	–	–
Average Data Duty Cycle	–	–	50%	–	–	–
Decoder Oscillator	F_{ENC}	–	70	–	kHz	–
Output Drive Current	–	0.6	1.0	1.2	mA	7
ENVIRONMENTAL						
Operating Temperature Range	–	-40	–	+70	$^{\circ}$ C	5

Table 1: KH2 Series Receiver Specifications

Notes

- The KH2 can utilize a 4.3 to 5.2VDC supply provided a 330-ohm resistor is placed in series with VCC.
- Into a 50-ohm load.
- When operating from a 5V source, it is important to consider that the output will swing to well less than 5 volts as a result of the required dropping resistor. Please verify that the minimum voltage will meet the high threshold requirement of the device to which data is being sent.
- For BER of 10^{-5} at 1,200bps.
- Characterized, but not tested.
- Time to valid data output.
- Maximum drive capability of data outputs.

ABSOLUTE MAXIMUM RATINGS

Supply Voltage V_{CC}	-0.3	to	+3.6	VDC
Supply Voltage V_{CC} , Using Resistor	-0.3	to	+5.2	VDC
Any Input or Output Pin	-0.3	to	+3.6	VDC
RF Input			0	dBm
Operating Temperature	-30	to	+70	$^{\circ}$ C
Storage Temperature	-45	to	+85	$^{\circ}$ C
Soldering Temperature			+225 $^{\circ}$ C	for 10 seconds

NOTE Exceeding any of the limits of this section may lead to permanent damage to the device. Furthermore, extended operation at these maximum ratings may reduce the life of this device.

PERFORMANCE DATA

These performance parameters are based on module operation at 25 $^{\circ}$ C from a 3.0VDC supply unless otherwise noted. Figure 2 illustrates the connections necessary for testing and operation. It is recommended all ground pins be connected to the ground plane. The pins marked NC have no electrical connection and are designed only to add physical support.

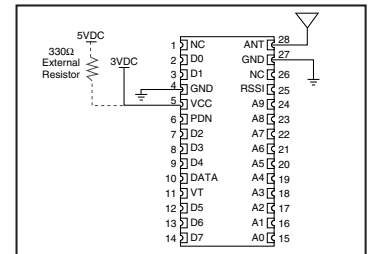

Figure 2: Test / Basic Application Circuit

TYPICAL PERFORMANCE GRAPHS

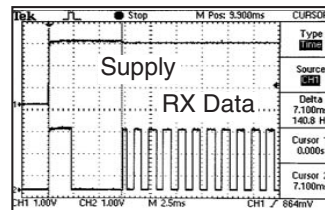

Figure 3: Turn-On Time from V_{CC}

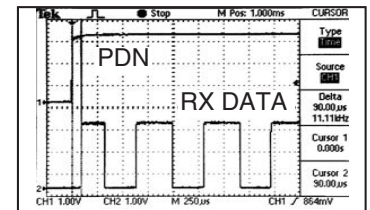

Figure 4: Turn-On Time from PDN

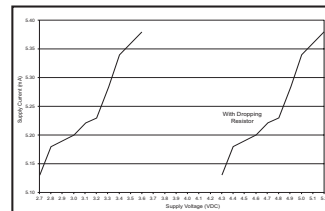

Figure 5: Consumption vs. Supply

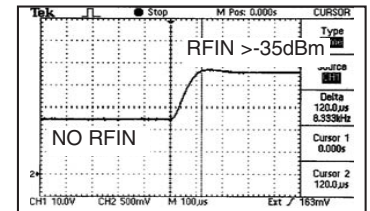

Figure 6: RSSI Response Time

PIN ASSIGNMENTS

1	NC	ANT	28
2	D0	GND	27
3	D1	NC	26
4	GND	RSSI	25
5	VCC	A9	24
6	PDN	A8	23
7	D2	A7	22
8	D3	A6	21
9	D4	A5	20
10	DATA	A4	19
11	VT	A3	18
12	D5	A2	17
13	D6	A1	16
14	D7	A0	15

Figure 7: KH2 Series Receiver Pinout (Top View)

PIN DESCRIPTIONS

Pin #	Name	Description
1	NC	No Connection. For physical support only.
2, 3, 7, 8, 9, 12, 13, 14	D0-D7	Data Output Lines. Upon a valid transmission, these lines will be set to replicate the state of the transmitter's data lines.
4	GND	Analog Ground
5	V _{CC}	Supply Voltage
6	PDN	Power Down. Pulling this line low will place the receiver into a low-current state. The module will not be able to receive a signal in this state.
10	DATA	Data output of the receiver prior to the encoder.
11	VT	Valid Transmission. This line will go high when a valid transmission is received.
15-24	A0-A9	Address Lines. The state of these lines must match the state of the transmitter's address lines in order for a transmission to be accepted.
25	RSSI	Received Signal Strength Indicator. This line will supply an analog voltage that is proportional to the strength of the received signal.
26	NC	No Connection. For physical support only.
27	GND	Analog Ground
28	RF IN	50-ohm RF Input

MODULE DESCRIPTION

The KH2 Series module combines the popular Linx LR Series receiver with a decoder IC in a convenient SMD package. The module is ideal for general-purpose remote control and command applications. When paired with a matching Linx KH Series transmitter / encoder, OEM transmitter, LC, or LR Series transmitter and Holtek HT640 encoder combination, a highly reliable RF link is formed, capable of transferring control and command data over line-of-sight distances in excess of 3,000 feet. The on-board receiver / decoder combination provides eight switched outputs that correspond to the state of the data lines on the transmitter's encoder. Ten tri-state address lines are also provided to allow up to 59,049 (3¹⁰) unique identification codes.

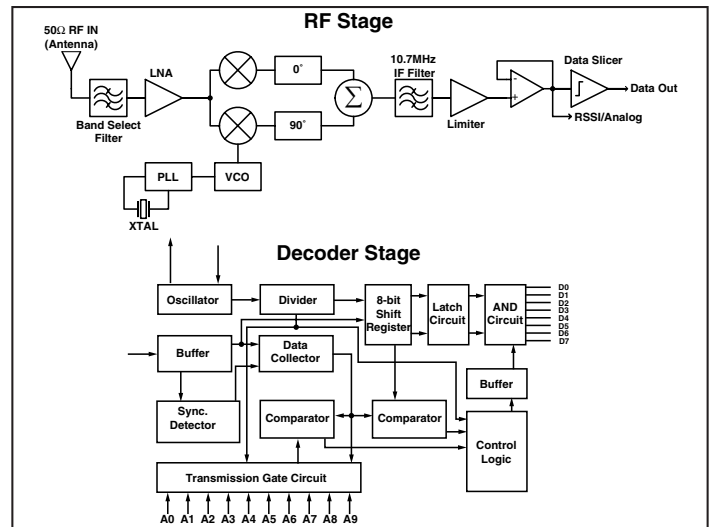

Figure 8: KH2 Series Receiver Block Diagram

THEORY OF OPERATION

The KH2 Series receiver module is designed to receive transmissions from a matching KH Series transmitter module or other compatible Linx transmitter product. When transmitted data is received, the data is presented to the on-board decoder. If the incoming address matches the local address settings, the decoder's outputs are set to replicate the states of the transmitter's data lines.

The RF section of the KH2 module utilizes an advanced single-conversion superhet design with a synthesized architecture, high IF frequency, and multi-layer ceramic filters. The exceptional accuracy of the crystal-based synthesized architecture in the KH2 receiver module allows the receiver's pass band to be quite narrow, thus increasing sensitivity and reducing susceptibility to near-band interference.

DECODER OPERATION

The KH2 Series receiver utilizes the HT658 decoder from Holtek. The decoder receives data transmitted by the encoder and interprets the first 10 bits of the code period as address and the last 8 bits as data. A signal on the DATA line activates the oscillator, which in turn decodes the incoming address and data. The decoder will check the received address twice continuously. If the received address code matches the decoder's local address, the 8 bits of data are replicated on the output lines, and the VT line is set high to indicate the reception of a valid transmission. That will last until the address code is incorrect or no signal has been received. The VT line is high only when the transmission is valid, otherwise it is low. The data outputs are momentary, and follow the encoder during a valid transmission, then reset.

The oscillator is disabled in the standby state and activated as long as a logic "high" signal is applied to the DATA line, so the DATA line should be kept "low" if there is no signal input.

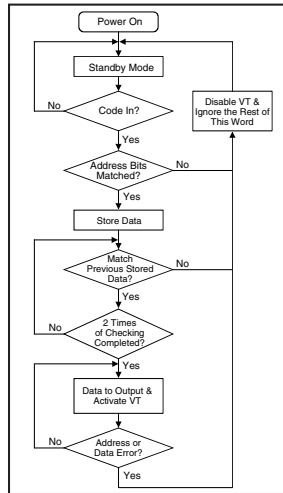

Figure 9: Decoder Flowchart

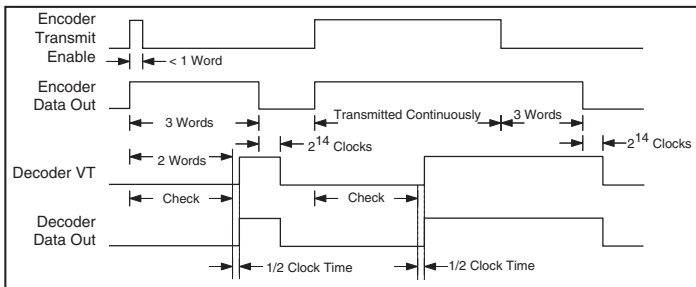

Figure 10: Encoder / Decoder Timing Diagram

SETTING THE RECEIVER ADDRESS

The module provides ten tri-state address lines. This allows for the formation of up to 59,049 (3^{10}) unique receiver-transmitter relationships. Tri-state means that the address lines can be set to one of three distinct states: high, low, or floating. These lines may be hardwired or configured via a microprocessor, DIP switch, or jumpers.

The receiver's address line states must match the transmitter's exactly for a transmission to be recognized. If the transmitted address does not match the receiver's local address, then the receiver will take no action.

THE DATA OUTPUTS

When data is received and the incoming address data matches with the local address settings, the module's eight data output lines are set to replicate the state of the transmitter's data lines. In addition, the valid transmission line (VT, Pin 11) will go high to indicate reception and decoding of the data. The data lines have a low sink and source capability, so external buffering is generally required if loads are to be driven directly.

In addition to the decoded data outputs, raw data is also available via a CMOS-compatible data output (DATA, Pin 10). The output of this line is the actual received data stream from the receiver and is always active regardless of address line status. It is made available for troubleshooting or monitoring internal data flow. It can also be used in mixed-mode systems where data may come from another source in addition to a KH Series transmitter module. This data can then be channeled to an external processor for decoding.

RECEIVING DATA

Although the internal decoder handles all of the decoding and output for transmissions from a KH Series transmitter or an OEM transmitter, the KH2 Series receiver will output the raw received data on the DATA line. This allows the designer to create a mixed system of KH Series or OEM transmitters for encoded data as well as LC or LR Series transmitters for custom data.

When using the KH2 for custom data transmissions, it is up to the designer to implement a noise-tolerant protocol to ensure the integrity of the data. Application Note AN-00160 will provide some suggestions and guidelines.

The KH2 Series receiver module contains the LR Series receiver, which has a CMOS-compatible output capable of directly driving a microprocessor, an RS-232 level converter, or a Linx QS Series USB module. The LR Series receiver manual can be consulted for more details on the operation of the receiver itself.

POWER SUPPLY REQUIREMENTS

The module does not have an internal voltage regulator; therefore it requires a clean, well-regulated power source. While it is preferable to power the unit from a battery, it can also be operated from a power supply as long as noise is less than 20mV. Power supply noise can affect the receiver sensitivity; therefore, providing a clean power supply for the module should be a high priority during design.

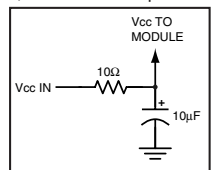

Figure 11: Supply Filter

A 10Ω resistor in series with the supply followed by a 10μF tantalum capacitor from V_{CC} to ground will help in cases where the quality of supply power is poor. These values may need to be adjusted depending on the noise present on the supply line. Note that operation from 4.3 to 5.2 volts requires the use of an external 330Ω resistor placed in series with the supply to prevent V_{CC} from exceeding 3.6 volts, so the dropping resistor can take the place of the 10Ω resistor in the supply filter.

USING THE RSSI PIN

The receiver's Received Signal Strength Indicator (RSSI) line serves a variety of functions. This line has a dynamic range of 80dB (typical) and outputs a voltage proportional to the incoming signal strength. It should be noted that the RSSI levels and dynamic range will vary slightly from part to part. It is also important to remember that RSSI output indicates the strength of any in-band RF energy and not necessarily just that from the intended transmitter; therefore, it should be used only to qualify the level and presence of a signal.

The RSSI output can be utilized during testing or even as a product feature to assess interference and channel quality by looking at the RSSI level with all intended transmitters shut off. The RSSI output can also be used in direction-finding applications, although there are many potential perils to consider in such systems. Finally, it can be used to save system power by "waking up" external circuitry when a transmission is received or crosses a certain threshold. The RSSI output feature adds tremendous versatility for the creative designer.

INTERFERENCE CONSIDERATIONS

The RF spectrum is crowded and the potential for conflict with other unwanted sources of RF is very real. While all RF products are at risk from interference, its effects can be minimized by better understanding its characteristics.

Interference may come from internal or external sources. The first step is to eliminate interference from noise sources on the board. This means paying careful attention to layout, grounding, filtering, and bypassing in order to eliminate all radiated and conducted interference paths. For many products, this is straightforward; however, products containing components such as switching power supplies, motors, crystals, and other potential sources of noise must be approached with care. Comparing your own design with a Linx evaluation board can help to determine if and at what level design-specific interference is present.

External interference can manifest itself in a variety of ways. Low-level interference will produce noise and hashing on the output and reduce the link's overall range.

High-level interference is caused by nearby products sharing the same frequency or from near-band high-power devices. It can even come from your own products if more than one transmitter is active in the same area. It is important to remember that only one transmitter at a time can occupy a frequency, regardless of the coding of the transmitted signal. This type of interference is less common than those mentioned previously, but in severe cases it can prevent all useful function of the affected device.

Although technically it is not interference, multipath is also a factor to be understood. Multipath is a term used to refer to the signal cancellation effects that occur when RF waves arrive at the receiver in different phase relationships. This effect is a particularly significant factor in interior environments where objects provide many different signal reflection paths. Multipath cancellation results in lowered signal levels at the receiver and, thus, shorter useful distances for the link.

TYPICAL APPLICATIONS

The figure below shows an example of a basic remote control receiver utilizing the KH2 Series receiver module. When a key is pressed on the transmitter, a corresponding line on the receiver goes high. A schematic for the transmitter / encoder circuit may be found in the KH Series Transmitter Data Guide. These circuits are implemented in the KH Series Basic Evaluation Kit. They can be easily modified for a custom application and clearly demonstrate the ease of using the Linx KH Series modules for remote control applications.

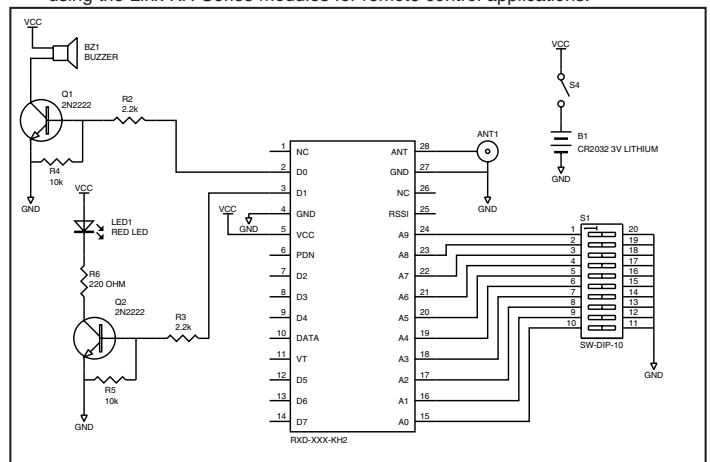

Figure 12: Basic Remote Control Receiver

The ten-position DIP switch is used to set the address to either ground or floating. Since the floating state is a valid state, no pull-up resistors are needed.

The data line outputs can only source about 1mA of current, so transistor buffers are used to drive the buzzer and LED. 1mA is sufficient to activate most microcontrollers, but the manufacturer's data guides should be consulted to make sure.

The KH2 Series receiver / decoder module is also suitable for use with Linx OEM handheld transmitters. These transmitters are FCC certified, making product introduction extremely quick. Information on these transmitters can be found on the Linx website at www.linxtechnologies.com.



Figure 13: Linx OEM Transmitters



Figure 14: Linx OEM Keyfobs

BOARD LAYOUT GUIDELINES

If you are at all familiar with RF devices, you may be concerned about specialized board layout requirements. Fortunately, because of the care taken by Linx in designing the modules, integrating them is very straightforward. Despite this ease of application, it is still necessary to maintain respect for the RF stage and exercise appropriate care in layout and application in order to maximize performance and ensure reliable operation. The antenna can also be influenced by layout choices. Please review this data guide in its entirety prior to beginning your design. By adhering to good layout principles and observing some basic design rules, you will be on the path to RF success.

The adjacent figure shows the suggested PCB footprint for the module. The actual pad dimensions are shown in the Pad Layout section of this manual. A ground plane (as large as possible) should be placed on a lower layer of your PCB opposite the module. This ground plane can also be critical to the performance of your antenna, which will be discussed later. There should not be any ground or traces under the module on the same layer as the module, just bare PCB.

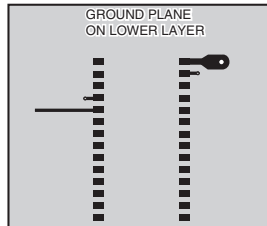

Figure 15: Suggested PCB Layout

During prototyping, the module should be soldered to a properly laid-out circuit board. The use of prototyping or "perf" boards will result in horrible performance and is strongly discouraged.

No conductive items should be placed within 0.15in of the module's top or sides.

Do not route PCB traces directly under the module. The underside of the module has numerous signal-bearing traces and vias that could short or couple to traces on the product's circuit board.

The module's ground lines should each have their own via to the ground plane and be as short as possible.

AM / OOK receivers are particularly subject to noise. The module should, as much as reasonably possible, be isolated from other components on your PCB, especially high-frequency circuitry such as crystal oscillators, switching power supplies, and high-speed bus lines. Make sure internal wiring is routed away from the module and antenna, and is secured to prevent displacement.

The power supply filter should be placed close to the module's V_{CC} line.

In some instances, a designer may wish to encapsulate or "pot" the product. Many Linx customers have done this successfully; however, there are a wide variety of potting compounds with varying dielectric properties. Since such compounds can considerably impact RF performance, it is the responsibility of the designer to carefully evaluate and qualify the impact and suitability of such materials.

The trace from the module to the antenna should be kept as short as possible. A simple trace is suitable for runs up to 1/8-inch for antennas with wide bandwidth characteristics. For longer runs or to avoid detuning narrow bandwidth antennas, such as a helical, use a 50-ohm coax or 50-ohm microstrip transmission line as described in the following section.

MICROSTRIP DETAILS

A transmission line is a medium whereby RF energy is transferred from one place to another with minimal loss. This is a critical factor, especially in high-frequency products like Linx RF modules, because the trace leading to the module's antenna can effectively contribute to the length of the antenna, changing its resonant bandwidth. In order to minimize loss and detuning, some form of transmission line between the antenna and the module should be used, unless the antenna can be placed very close (<1/8in.) to the module. One common form of transmission line is a coax cable, another is the microstrip. This term refers to a PCB trace running over a ground plane that is designed to serve as a transmission line between the module and the antenna. The width is based on the desired characteristic impedance of the line, the thickness of the PCB, and the dielectric constant of the board material. For standard 0.062in thick FR-4 board material, the trace width would be 111 mils. The correct trace width can be calculated for other widths and materials using the information below. Handy software for calculating microstrip lines is also available on the Linx website, www.linxtechnologies.com.

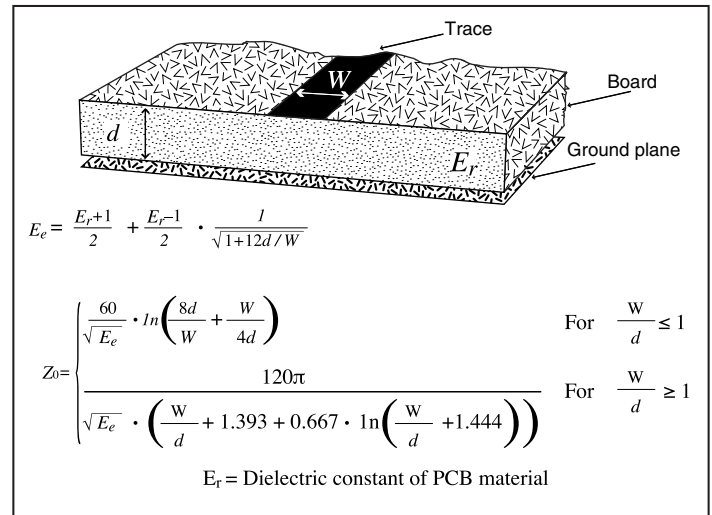

Figure 16: Microstrip Formulas

Dielectric Constant	Width/Height (W/d)	Effective Dielectric Constant	Characteristic Impedance
4.80	1.8	3.59	50.0
4.00	2.0	3.07	51.0
2.55	3.0	2.12	48.0

PAD LAYOUT

The following pad layout diagram is designed to facilitate both hand and automated assembly.

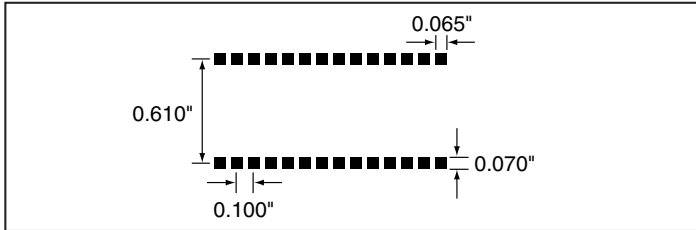

Figure 17: Recommended PCB Layout

PRODUCTION GUIDELINES

The modules are housed in a hybrid SMD package that supports hand or automated assembly techniques. Since the modules contain discrete components internally, the assembly procedures are critical to ensuring the reliable function of the modules. The following procedures should be reviewed with and practiced by all assembly personnel.

HAND ASSEMBLY

Pads located on the bottom of the module are the primary mounting surface. Since these pads are inaccessible during mounting, castellations that run up the side of the module have been provided to facilitate solder wicking to the module's underside. This allows for very quick hand soldering for prototyping and small volume production.

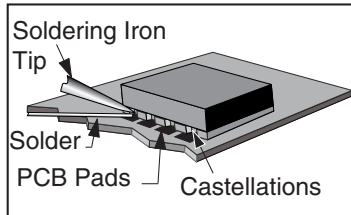

Figure 18: Soldering Technique

If the recommended pad guidelines have been followed, the pads will protrude slightly past the edge of the module. Use a fine soldering tip to heat the board pad and the castellation, then introduce solder to the pad at the module's edge. The solder will wick underneath the module, providing reliable attachment. Tack one module corner first and then work around the device, taking care not to exceed the times listed below.

Absolute Maximum Solder Times

Hand-Solder Temp. TX +225°C for 10 Seconds

Hand-Solder Temp. RX +225°C for 10 Seconds

Recommended Solder Melting Point +180°C

Reflow Oven: +220°C Max. (See adjoining diagram)

AUTOMATED ASSEMBLY

For high-volume assembly, most users will want to auto-place the modules. The modules have been designed to maintain compatibility with reflow processing techniques; however, due to their hybrid nature, certain aspects of the assembly process are far more critical than for other component types.

Following are brief discussions of the three primary areas where caution must be observed.

Reflow Temperature Profile

The single most critical stage in the automated assembly process is the reflow stage. The reflow profile below should not be exceeded, since excessive temperatures or transport times during reflow will irreparably damage the modules. Assembly personnel will need to pay careful attention to the oven's profile to ensure that it meets the requirements necessary to successfully reflow all components while still remaining within the limits mandated by the modules. The figure below shows the recommended reflow oven profile for the modules.

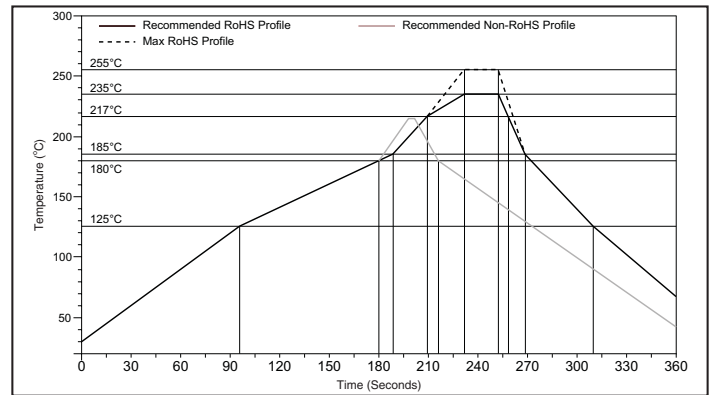

Figure 19: Maximum Reflow Profile

Shock During Reflow Transport

Since some internal module components may reflow along with the components placed on the board being assembled, it is imperative that the modules not be subjected to shock or vibration during the time solder is liquid. Should a shock be applied, some internal components could be lifted from their pads, causing the module to not function properly.

Washability

The modules are wash resistant, but are not hermetically sealed. Linx recommends wash-free manufacturing; however, the modules can be subjected to a wash cycle provided that a drying time is allowed prior to applying electrical power to the modules. The drying time should be sufficient to allow any moisture that may have migrated into the module to evaporate, thus eliminating the potential for shorting damage during power-up or testing. If the wash contains contaminants, the performance may be adversely affected, even after drying.

ANTENNA CONSIDERATIONS

The choice of antennas is a critical and often overlooked design consideration. The range, performance, and legality of an RF link are critically dependent upon the antenna. While adequate antenna performance can often be obtained by trial and error methods, antenna design and matching is a complex task. A professionally designed antenna, such as those from Linx, will help ensure maximum performance and FCC compliance.

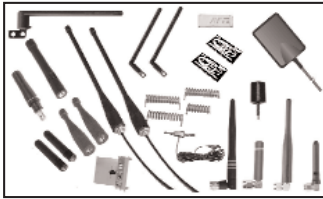

Figure 20: Linx Antennas

Linx transmitter modules typically have an output power that is slightly higher than the legal limits. This allows the designer to use an inefficient antenna, such as a loop trace or helical, to meet size, cost, or cosmetic requirements and still achieve full legal output power for maximum range. If an efficient antenna is used, then some attenuation of the output power will likely be needed. This can easily be accomplished by using the LADJ line or a T-pad attenuator. For more details on T-pad attenuator design, please see Application Note AN-00150.

A receiver antenna should be optimized for the frequency or band in which the receiver operates and to minimize the reception of off-frequency signals. The efficiency of the receiver's antenna is critical to maximizing range performance. Unlike the transmitter antenna, where legal operation may mandate attenuation or a reduction in antenna efficiency, the receiver's antenna should be optimized as much as is practical.

It is usually best to utilize a basic quarter-wave whip until your prototype product is operating satisfactorily. Other antennas can then be evaluated based on the cost, size, and cosmetic requirements of the product. You may wish to review Application Note AN-00500 "Antennas: Design, Application, Performance"

ANTENNA SHARING

In cases where a transmitter and receiver module are combined to form a transceiver, it is often advantageous to share a single antenna. To accomplish this, an antenna switch must be used to provide isolation between the modules so that the full transmitter output power is not put on the sensitive front end of the receiver. There are a wide variety of antenna switches that are cost-effective and easy to use. Among the most popular are switches from Macom and NEC. Look for an antenna switch that has high isolation and low loss at the desired frequency of operation. Generally, the Tx or Rx status of a switch will be controlled by a product's microprocessor, but the user may also make the selection manually. In some cases, where the characteristics of the Tx and Rx antennas need to be different or antenna switch losses are unacceptable, it may be more appropriate to utilize two discrete antennas.

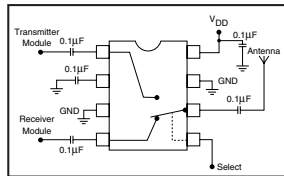

Figure 21: Typical Antenna Switch

GENERAL ANTENNA RULES

The following general rules should help in maximizing antenna performance.

1. Proximity to objects such as a user's hand, body, or metal objects will cause an antenna to detune. For this reason, the antenna shaft and tip should be positioned as far away from such objects as possible.
2. Optimum performance will be obtained from a 1/4- or 1/2-wave straight whip mounted at a right angle to the ground plane. In many cases, this isn't desirable for practical or ergonomic reasons, thus, an alternative antenna style such as a helical, loop, or patch may be utilized and the corresponding sacrifice in performance accepted.

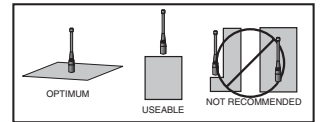

Figure 22: Ground Plane Orientation

3. If an internal antenna is to be used, keep it away from other metal components, particularly large items like transformers, batteries, PCB tracks, and ground planes. In many cases, the space around the antenna is as important as the antenna itself. Objects in close proximity to the antenna can cause direct detuning, while those farther away will alter the antenna's symmetry.

4. In many antenna designs, particularly 1/4-wave whips, the ground plane acts as a counterpoise, forming, in essence, a 1/2-wave dipole. For this reason, adequate ground plane area is essential. The ground plane can be a metal case or ground-fill areas on a circuit board. Ideally, it should have a surface area \geq the overall length of the 1/4-wave radiating element. This is often not practical due to size and configuration constraints. In these instances, a designer must make the best use of the area available to create as much ground plane as possible in proximity to the base of the antenna. In cases where the antenna is remotely located or the antenna is not in close proximity to a circuit board, ground plane, or grounded metal case, a metal plate may be used to maximize the antenna's performance.

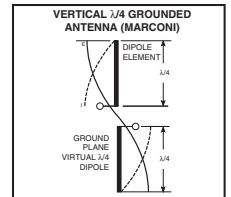

Figure 23: Dipole Antenna

5. Remove the antenna as far as possible from potential interference sources. Any frequency of sufficient amplitude to enter the receiver's front end will reduce system range and can even prevent reception entirely. Switching power supplies, oscillators, or even relays can also be significant sources of potential interference. The single best weapon against such problems is attention to placement and layout. Filter the module's power supply with a high-frequency bypass capacitor. Place adequate ground plane under potential sources of noise to shunt noise to ground and prevent it from coupling to the RF stage. Shield noisy board areas whenever practical.

6. In some applications, it is advantageous to place the module and antenna away from the main equipment. This can avoid interference problems and allows the antenna to be oriented for optimum performance. Always use 50Ω coax, like RG-174, for the remote feed.

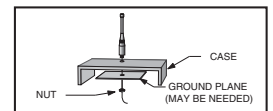

Figure 24: Remote Ground Plane

COMMON ANTENNA STYLES

There are literally hundreds of antenna styles and variations that can be employed with Linx RF modules. Following is a brief discussion of the styles most commonly utilized. Additional antenna information can be found in Linx Application Notes AN-00100, AN-00140, and AN-00500. Linx antennas and connectors offer outstanding performance at a low price.

Whip Style



$$L = \frac{234}{F_{\text{MHz}}}$$

Where:
L = length in feet of quarter-wave length
F = operating frequency in megahertz

A whip-style antenna provides outstanding overall performance and stability. A low-cost whip is can be easily fabricated from a wire or rod, but most designers opt for the consistent performance and cosmetic appeal of a professionally-made model. To meet this need, Linx offers a wide variety of straight and reduced-height whip-style antennas in permanent and connectorized mounting styles.

The wavelength of the operational frequency determines an antenna's overall length. Since a full wavelength is often quite long, a partial 1/2- or 1/4-wave antenna is normally employed. Its size and natural radiation resistance make it well matched to Linx modules. The proper length for a straight 1/4-wave can be easily determined using the adjacent formula. It is also possible to reduce the overall height of the antenna by using a helical winding. This reduces the antenna's bandwidth, but is a great way to minimize the antenna's physical size for compact applications. This also means that the physical appearance is not always an indicator of the antenna's frequency.

Specialty Styles



Linx offers a wide variety of specialized antenna styles. Many of these styles utilize helical elements to reduce the overall antenna size while maintaining reasonable performance. A helical antenna's bandwidth is often quite narrow and the antenna can detune in proximity to other objects, so care must be exercised in layout and placement.

Loop Style



A loop- or trace-style antenna is normally printed directly on a product's PCB. This makes it the most cost-effective of antenna styles. The element can be made self-resonant or externally resonated with discrete components, but its actual layout is usually product specific. Despite the cost advantages, loop-style antennas are generally inefficient and useful only for short-range applications. They are also very sensitive to changes in layout and PCB dielectric, which can cause consistency issues during production. In addition, printed styles are difficult to engineer, requiring the use of expensive equipment, including a network analyzer. An improperly designed loop will have a high SWR at the desired frequency, which can cause instability in the RF stage.

Linx offers low-cost planar and chip antennas that mount directly to a product's PCB. These tiny antennas do not require testing and provide excellent performance in light of their small size. They offer a preferable alternative to the often-problematic "printed" antenna.

ONLINE RESOURCES



www.linxtechnologies.com

- Latest News
- Data Guides
- Application Notes
- Knowledgebase
- Software Updates



If you have questions regarding any Linx product and have Internet access, make www.linxtechnologies.com your first stop. Our website is organized in an intuitive format to immediately give you the answers you need. Day or night, the Linx website gives you instant access to the latest information regarding the products and services of Linx. It's all here: manual and software updates, application notes, a comprehensive knowledgebase, FCC information, and much more. Be sure to visit often!



www.antennafactor.com

The Antenna Factor division of Linx offers a diverse array of antenna styles, many of which are optimized for use with our RF modules. From innovative embeddable antennas to low-cost whips, domes to Yagis, and even GPS, Antenna Factor likely has an antenna for you, or can design one to meet your requirements.



www.connectorcity.com

Through its Connector City division, Linx offers a wide selection of high-quality RF connectors, including FCC-compliant types such as RP-SMAs that are an ideal match for our modules and antennas. Connector City focuses on high-volume OEM requirements, which allows standard and custom RF connectors to be offered at a remarkably low cost.



LEGAL CONSIDERATIONS

NOTE: Linx RF modules are designed as component devices that require external components to function. The modules are intended to allow for full Part 15 compliance; however, they are not approved by the FCC or any other agency worldwide. The purchaser understands that approvals may be required prior to the sale or operation of the device, and agrees to utilize the component in keeping with all laws governing its use in the country of operation.

When working with RF, a clear distinction must be made between what is technically possible and what is legally acceptable in the country where operation is intended. Many manufacturers have avoided incorporating RF into their products as a result of uncertainty and even fear of the approval and certification process. Here at Linx, our desire is not only to expedite the design process, but also to assist you in achieving a clear idea of what is involved in obtaining the necessary approvals to legally market your completed product.

In the United States, the approval process is actually quite straightforward. The regulations governing RF devices and the enforcement of them are the responsibility of the Federal Communications Commission (FCC). The regulations are contained in Title 47 of the Code of Federal Regulations (CFR). Title 47 is made up of numerous volumes; however, all regulations applicable to this module are contained in Volume 0-19. It is strongly recommended that a copy be obtained from the Government Printing Office in Washington or from your local government bookstore. Excerpts of applicable sections are included with Linx evaluation kits or may be obtained from the Linx Technologies website, www.linxtechnologies.com. In brief, these rules require that any device that intentionally radiates RF energy be approved, that is, tested for compliance and issued a unique identification number. This is a relatively painless process. Linx offers full EMC pre-compliance testing in our HP / Emco-equipped test center. Final compliance testing is then performed by one of the many independent testing laboratories across the country. Many labs can also provide other certifications that the product may require at the same time, such as UL, CLASS A / B, etc. Once your completed product has passed, you will be issued an ID number that is to be clearly placed on each product manufactured.

Questions regarding interpretations of the Part 2 and Part 15 rules or measurement procedures used to test intentional radiators, such as Linx RF modules, for compliance with the technical standards of Part 15, should be addressed to:

Federal Communications Commission
Equipment Authorization Division
Customer Service Branch, MS 1300F2
7435 Oakland Mills Road
Columbia, MD 21046

Phone: (301) 725-1585 Fax: (301) 344-2050 E-Mail: labinfo@fcc.gov

International approvals are slightly more complex, although Linx modules are designed to allow all international standards to be met. If you are considering the export of your product abroad, you should contact Linx Technologies to determine the specific suitability of the module to your application.

All Linx modules are designed with the approval process in mind and thus much of the frustration that is typically experienced with a discrete design is eliminated. Approval is still dependent on many factors, such as the choice of antennas, correct use of the frequency selected, and physical packaging. While some extra cost and design effort are required to address these issues, the additional usefulness and profitability added to a product by RF makes the effort more than worthwhile.

ACHIEVING A SUCCESSFUL RF IMPLEMENTATION

Adding an RF stage brings an exciting new dimension to any product. It also means that additional effort and commitment will be needed to bring the product successfully to market. By utilizing premade RF modules, such as the LR Series, the design and approval process is greatly simplified. It is still important, however, to have an objective view of the steps necessary to ensure a successful RF integration. Since the capabilities of each customer vary widely, it is difficult to recommend one particular design path, but most projects follow steps similar to those shown at the right.

In reviewing this sample design path, you may notice that Linx offers a variety of services (such as antenna design and FCC prequalification) that are unusual for a high-volume component manufacturer. These services, along with an exceptional level of technical support, are offered because we recognize that RF is a complex science requiring the highest caliber of products and support. "Wireless Made Simple" is more than just a motto, it's our commitment. By choosing Linx as your RF partner and taking advantage of the resources we offer, you will not only survive implementing RF, you may even find the process enjoyable.

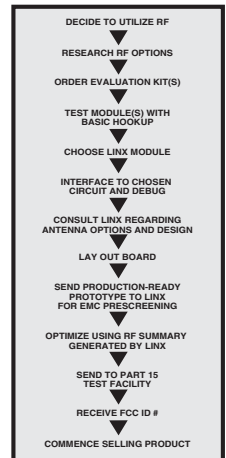

Typical Steps For Implementing RF

HELPFUL APPLICATION NOTES FROM LINX

It is not the intention of this manual to address in depth many of the issues that should be considered to ensure that the modules function correctly and deliver the maximum possible performance. As you proceed with your design, you may wish to obtain one or more of the following application notes, which address in depth key areas of RF design and application of Linx products. These applications notes are available online at www.linxtechnologies.com or by contacting the Linx literature department.

NOTE	APPLICATION NOTE TITLE
AN-00100	RF 101: Information for the RF Challenged
AN-00125	Considerations For Operation Within The 260-470MHz Band
AN-00130	Modulation Techniques For Low-Cost RF Data Links
AN-00140	The FCC Road: Part 15 From Concept To Approval
AN-00150	Use and Design of T-Attenuation Pads
AN-00160	Considerations For Sending Data Over a Wireless Link
AN-00300	Addressing Linx OEM Products
AN-00500	Antennas: Design, Application, Performance



U.S. CORPORATE HEADQUARTERS

LINX TECHNOLOGIES, INC.

**159 ORT LANE
MERLIN, OR 97532**

PHONE: (541) 471-6256

FAX: (541) 471-6251

www.linxtechnologies.com

Disclaimer

Linx Technologies is continually striving to improve the quality and function of its products. For this reason, we reserve the right to make changes to our products without notice. The information contained in this Overview Guide is believed to be accurate as of the time of publication. Specifications are based on representative lot samples. Values may vary from lot-to-lot and are not guaranteed. "Typical" parameters can and do vary over lots and application. Linx Technologies makes no guarantee, warranty, or representation regarding the suitability of any product for use in any specific application. It is the customer's responsibility to verify the suitability of the part for the intended application. NO LINX PRODUCT IS INTENDED FOR USE IN ANY APPLICATION WHERE THE SAFETY OF LIFE OR PROPERTY IS AT RISK.

Linx Technologies DISCLAIMS ALL WARRANTIES OF MERCHANTABILITY AND FITNESS FOR A PARTICULAR PURPOSE. IN NO EVENT SHALL LINX TECHNOLOGIES BE LIABLE FOR ANY OF CUSTOMER'S INCIDENTAL OR CONSEQUENTIAL DAMAGES ARISING IN ANY WAY FROM ANY DEFECTIVE OR NON-CONFORMING PRODUCTS OR FOR ANY OTHER BREACH OF CONTRACT BY LINX TECHNOLOGIES. The limitations on Linx Technologies' liability are applicable to any and all claims or theories of recovery asserted by Customer, including, without limitation, breach of contract, breach of warranty, strict liability, or negligence. Customer assumes all liability (including, without limitation, liability for injury to person or property, economic loss, or business interruption) for all claims, including claims from third parties, arising from the use of the Products. The Customer will indemnify, defend, protect, and hold harmless Linx Technologies and its officers, employees, subsidiaries, affiliates, distributors, and representatives from and against all claims, damages, actions, suits, proceedings, demands, assessments, adjustments, costs, and expenses incurred by Linx Technologies as a result of or arising from any Products sold by Linx Technologies to Customer. Under no conditions will Linx Technologies be responsible for losses arising from the use or failure of the device in any application, other than the repair, replacement, or refund limited to the original product purchase price. Devices described in this publication may contain proprietary, patented, or copyrighted techniques, components, or materials. Under no circumstances shall any user be conveyed any license or right to the use or ownership of such items.

© 2008 by Linx Technologies, Inc. The stylized Linx logo, Linx, "Wireless Made Simple", CipherLinx, and the stylized CL logo are the trademarks of Linx Technologies, Inc.
Printed in U.S.A.