

9XTend-PKG-E™ Ethernet RF Modem

9XTend Ethernet RF Modem
System Setup
RF Modem Operation
RF Modem Configuration
RF Communication Modes
Appendices



Product Manual [v2.x4x](#)

For RF Modem Part Numbers: XT09-PK...-E...

1 Watt Transmit Power, 256-bit AES Encryption



355 South 520 West, Suite 180
Lindon, UT 84042
Phone: (801) 765-9885
Fax: (801) 765-9895

rf-xperts@maxstream.net
www.MaxStream.net (live chat support)

M100217
2007.01.04

© 2007 MaxStream, Inc. All rights reserved

No part of the contents of this manual may be transmitted or reproduced in any form or by any means without the written permission of MaxStream, Inc.

XTend™ and XTend-PKG-E™ are trademarks of MaxStream, Inc.

Ethernet™ is a registered trademark of Xerox.

AES Encryption Source Code

© 2007, Dr. Brian Gladman, Worcester, UK. All rights reserved.

Conditions:

- Distributions of AES source code include the above copyright notice, this list of conditions and disclaimer.

- Distributions in binary form include the above copyright notice, this list of conditions and disclaimer in the documentation and/or other associated materials.

- The copyright holder's name is not used to endorse products built using this software without specific written permission.

Alternatively, provided that this notice is retained in full, this product may be distributed under the terms of the GNU General Public License (GPL), in which case the provisions of the GPL apply INSTEAD OF those given above.

Disclaimer - This AES software is provided 'as is' with no explicit or implied warranties in respect of its properties, including, but not limited to, correctness and/or fitness for purpose.

Technical Support: Phone: (801) 765-9885
Live Chat: www.maxstream.net
E-mail: rf-xperts@maxstream.net

Contents

1. 9XTend Ethernet RF Modem	4	5. RF Communication Modes	45
1.1. Key Features	4	5.1. Addressing	46
1.1.1. Worldwide Acceptance	4	5.1.1. Address Recognition	46
1.2. Specifications	5	5.2. Basic Communications	47
1.3. External Interface	6	5.2.1. Streaming Mode (Default)	47
2. System Setup	7	5.2.2. Multi-Transmit Mode	48
2.1. Data Radio System Components	7	5.2.3. Repeater Mode	49
2.1.1. System Description	7	5.2.4. Polling Mode (Basic)	52
2.2. Com Port Communications	8	5.3. Acknowledged Communications	53
2.2.1. Install Software	8	5.3.1. Acknowledged Mode	53
2.2.2. Setup Com Port and IP Address	9	5.3.2. Polling Mode (Acknowledged)	55
2.2.3. Assign Static IP Address	10	Appendix A: Agency Certifications	56
2.2.4. Change Com Port Number	10	FCC (United States) Certification	56
2.2.5. Test Communications (X-CTU Loopback)	11	Labeling Requirements	56
2.3. Telnet Communications	12	FCC Notices	56
2.3.1. Test Communications (Telnet Loopback)	12	Limited Modular Approval	57
3. RF Modem Operation	13	FCC-approved Antennas	57
3.1. Serial Communications	13	IC (Industry Canada) Certification	60
3.1.1. Transparent Operation	13	Labeling Requirements	60
3.1.2. API Operation	13	C-TICK (Australia) Certification	60
3.2. Modes of Operation	14	Power Requirements	60
3.2.1. Idle Mode	14	Appendix B: Additional Information	61
3.2.2. Transmit Mode	14	1-Year Warranty	61
3.2.3. Receive Mode	16	Ordering Information	61
3.2.4. Sleep Mode	16	Contact MaxStream	62
3.2.5. Command Mode	18		
4. RF Modem Configuration	20		
4.1. Programming Examples	20		
4.1.1. Configuration Setup Options	20		
4.1.2. AT Command Examples	21		
4.1.3. Binary Command Example	21		
4.2. Command Reference Table	22		
4.3. Command Descriptions	24		
4.4. API Operation	42		
4.4.1. API Frame Specifications	42		
4.4.2. API Types	43		

1. 9XTend Ethernet RF Modem

The 9XTend RF Modem affords OEMs and integrators an easy-to-use RF solution that sustains reliable delivery of data between remote devices.

Out-of-box, the modem is configured to immediately sustain long range wireless links between devices. Simply feed serial data into one modem then the data will surface on the other end of the wireless link. The modem transfers a standard asynchronous serial data stream between devices.



1.1. Key Features

Long Range Data Integrity

- 1 Watt Power Output** (variable 1mW - 1W)
- Range (@9,600 bps throughput data rate):
 - Indoor/Urban: **up to 3000'** (900 m)
 - Outdoor RF line-of-sight: **up to 14 miles** (22 km) w/dipole antenna
 - Outdoor RF line-of-sight: **up to 40 miles** (64 km) w/high-gain antenna
- Range (@115,200 bps throughput data rate):
 - Indoor/Urban: **up to 1500'** (450 m)
 - Outdoor RF line-of-sight: **up to 7 miles** (11 km) w/dipole antenna
 - Outdoor RF line-of-sight: **up to 20 miles** (32 km) w/high-gain antenna
- Continuous RF data stream up to **115,200 bps**
- Receiver Sensitivity: **-110 dBm** (@ 9600 baud), **-100 dBm** (@ 115200 baud)

Advanced Networking & Security

- True Peer-to-Peer (no Master device required), Point-to-Point, Point-to-Multipoint & Multidrop
- Retries and Acknowledgements
- FHSS (Frequency Hopping Spread Spectrum)
- 10 hopping channels, each with over 65,000 unique network addresses available
- 256-bit AES Encryption**
(AES algorithm is FIPS-197 certified)

Low Power

- 7 - 28 V Supply Voltage
- Serial Port and Cyclic software sleep modes supported

Easy-to-Use

- No configuration necessary for out-of box RF communications
- Free X-CTU Software (Testing and configuration software)
- RF Modems easily configured using standard AT & binary commands
- Transparent Operation (Wireless links replace serial wires)
- API Operation (Frame-based communications)
- Portable (small form-factor easily designed into a wide range of data systems)
- Software-selectable I/O interfacing rates
- Multiple data formats supported (parity, start and stop bits, etc.)
- XII™ Interference Immunity
- No Master/Slave setup dependencies
- Free & Unlimited Technical Support**

1.1.1. Worldwide Acceptance

FCC Approved (USA) Refer to Appendix A [p56] for FCC Requirements. Systems that include XTend RF Modems inherit MaxStream's Certifications.

ISM (Industrial, Scientific & Medical) license-free 902-928 MHz frequency band
Manufactured under **ISO 9001:2000** registered standards

ESD (Electrostatic Discharge) immunity - ESD-hardened and IEC1000-4-2 (Level 4) tested
9XTend RF Modems are optimized for use in the **US, Canada, Australia and Israel**



1.2. Specifications

The XTend-PKG-E RF Modem ships configured to provide immediate long range wireless links between devices. The modem can be configured for additional functionality using standard AT and binary commands [Refer to the Command Mode [p18] & RF Modem Configuration [p20] sections].

The built-in Ethernet interface makes RF data available to any TCP/IP network. Once connected to a network, the XTend-PKG-E can be accessed through telnet; or, when used with the included Com Port Redirector Software, it can be mapped to a com port and accessed as a serial device.

Table 1-01. 9XTend-PKG-E Ethernet RF Modem Specifications

9XTend 900 MHz Ethernet RF Modem Specifications			
Performance	@9600 bps Throughput Data Rate	@115200 bps Throughput Data Rate	
Transmit Power Output (software selectable using PL command)	1mW - 1 Watt	1mW - 1 Watt	
Indoor/Urban Range	Up to 3000' (900 m)	Up to 1500' (450 m)	
Outdoor RF line-of-sight Range	Up to 14 miles (22 km) w/ dipole antenna Up to 40 miles (64 km) w/ high-gain antenna	Up to 7 miles (11 km) w/ dipole antenna Up to 20 miles (32 km) w/ high-gain antenna	
Interface Data Rate (software selectable using BD command)	1200 – 230400 bps	1200 – 230400 bps	
RF Data Rate	10,000 bps	125,000 bps	
Receiver Sensitivity	-110 dBm	-100 dBm	
Power Requirements			
Supply Voltage	7 - 28V	7 - 28V	
Receive Current	270 mA	270 mA	
Serial Port Sleep Power Down	210 mA	210 mA	
Idle Currents (9V supply voltage)	16 sec cyclic sleep (SM=8)	211 mA	210 mA
	8 sec cyclic sleep (SM=7)	212 mA	210 mA
	4 sec cyclic sleep (SM=6)	214 mA	211 mA
	2 sec cyclic sleep (SM=5)	218 mA	212 mA
	1 sec cyclic sleep (SM=4)	224 mA	215 mA
Networking & Security			
Frequency	902-928 MHz		
Spread Spectrum	FHSS (Frequency Hopping Spread Spectrum)		
Modulation	FSK (Frequency Shift Keying)		
Network Topologies Supported	Peer-to-Peer ("Master/Slave" relationship not required), Point-to-Point, Point-to-Multipoint & Multidrop		
Channel Capacity	10 hop sequences share 50 frequencies		
Supported Network Protocols	ARP, UDP, TCP, ICMP, Telnet, TFTP, AutoIP, DHCP, HTTP and SNMP		
Encryption	256-bit AES Encryption – Refer to the KY Command to implement		
Physical Properties			
RF Modem Board Size	2.750" x 5.500" x 1.125" (6.99cm x 13.97" x 2.86cm)		
Weight	7.1 oz. (200g)		
Serial Connector	RJ-45 Female Ethernet Connection		
Operating Temperature	-40 to 85° C (industrial)		
Antenna			
Connector	RPSMA (Reverse-polarity SMA)		
Type	Half-wave dipole whip, 6.75" (17.15cm), 2.1 dBi gain		
Impedance	50 ohms unbalanced		
Certifications (partial list)			
FCC Part 15.247	OUR-9XTEND		
Industry Canada (IC)	4214A-9XTEND		

Table 1-02. 9XTend-PKG-E Ethernet RF Modem Specifications - Relative to user-selected TX Power Output

Power Requirements (TX currents relative to each TX Power Output option)					
Transmit Power Output	1 mW	10 mW	100 mW	500 mW	1 W
Typical Transmit Current* (@115.2 Kbps) 9 VDC supply voltage	270 mA	290 mA	380 mA	600 mA	830 mA

* Divide by 2 for 18V supply (constant wattage from 7-28V)

1.3. External Interface

Figure 1-01. Front View

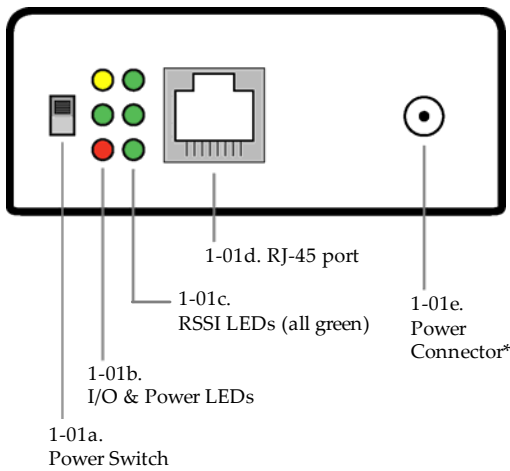

* The Ethernet RF Modem does not support Power-over-Ethernet (PoE). The device cannot be powered directly from a PoE port on a compatible hub.

However, it may be useful to send power on the unused wires of the CAT-5 cable in a situation where the radio will be mounted in a location that optimizes radio coverage, but may not have a power outlet nearby. There are several third party devices available that can inject the power onto the cable and then remove it at the remote side.

1-01a. Power Switch

Move Power Switch to the ON (up) position to power the XTend Ethernet RF Modem.

1-01b. I/O & Power LEDs

LEDs indicate modem activity as follows:

Yellow (top LED) = Serial Data Out (to host)
 Green (middle) = Serial Data In (from host)
 Red (bottom) = Power/TX Indicator (Red light is on when powered; it pulses on/off briefly during RF transmission.)



1-01c. RSSI LEDs

RSSI LEDs indicate the amount of fade margin present in an active wireless link. Fade margin is defined as the difference between the incoming signal strength and the modem's receiver sensitivity.

3 LEDs ON = Very Strong Signal (> 30 dB fade margin)
 2 LEDs ON = Strong Signal (> 20 dB fade margin)
 1 LED ON = Moderate Signal (> 10 dB fade margin)
 0 LED ON = Weak Signal (< 10 dB fade margin)

1-01d. RJ-45 Ethernet Port

Standard Female RJ-45 connector is used to connect unshielded twisted-pair CAT5 cabling.

1-01e. Power Connector*

7-28 VDC power connector

1-02a. Antenna Port

The antenna port is a 50Ω RF signal connector for connecting to an external antenna. The connector type is RPSMA (Reverse Polarity SMA) female. The connector has threads on the outside of a barrel and a male center conductor.

1-02b. Reset Switch

The Reset Switch is used to reset (re-boot) the RF modem and force the modem into AT Command Mode.

To reset (re-boot) the modem: Press and then immediately release the Reset Switch.

To force the modem into AT Command Mode (at the default throughput data rate of the modem): Press the Reset Switch and keep it depressed for at least two seconds, then release.

Figure 1-02. Back View

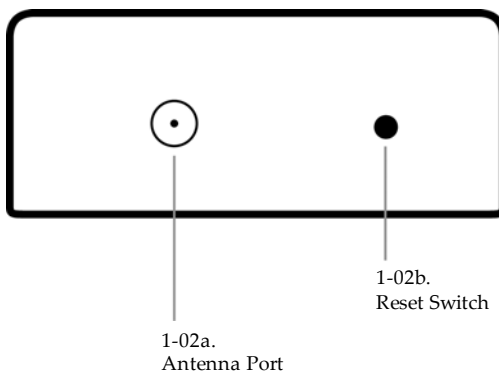

2. System Setup

2.1. Data Radio System Components

MaxStream RF Modems were designed to provide reliable wireless links between devices contained in a data system. The PKG-E Ethernet RF Modem allows integrators to connect the MaxStream Modems into an Ethernet network.

The following devices will be used to describe a data system that includes the XTend-PKG-E Ethernet RF Modem:



XTend-PKG-E Ethernet RF Modem ("PKG-E"): The Ethernet RF Modem is an Ethernet-connected serial modem used for communication with other MaxStream serial modems. The Ethernet RF Modem is not a wireless Ethernet Bridge intended for Ethernet connectivity on both the remote and base ends of a wireless link.



XTend-PKG-R RS-232/485 RF Modem ("PKG-R"): The RS-232/485 RF Modem is a serial modem that can be identified by its DB-9 serial port and 6-switch DIP Switch.

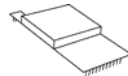

XTend OEM RF Module ("OEM RF Module"): The OEM RF Module is mounted inside all XTend-PKG RF Modems and may be integrated into OEM-designed products to transmit and receive data over-the-air.

2.1.1. System Description

The PKG-E Ethernet RF Modem can be used as an access point in a network of MaxStream RS-232/RS-485 RF Modems (or other OEM RF Module Embedded Devices). XTend RF Modems support point-to-point, peer-to-peer, point-to-multipoint and multidrop network topologies. Below is an example of a typical point-to-multipoint application:

Figure 2-01. XTend-PKG-E Ethernet RF Modem in a Point-to-Multipoint Data Radio System

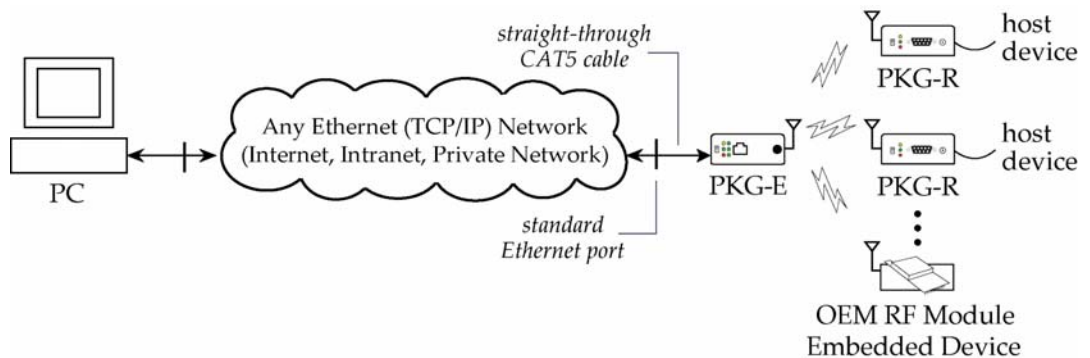

The Ethernet-connected RF modem supports com port and Telnet connection options:

- "Com Port Redirector Software enables legacy serial applications to communicate with the Ethernet RF Modem by forwarding serial data over Ethernet.
- "Telnet communicates directly to the Ethernet RF Modem using port 14001. Refer to the "Test Communications (Telnet Loopback)" section [p12] for an example that by-passes the com port.

2.2. Com Port Communications

2.2.1. Install Software

The X-CTU and Com Port Redirector software facilitate communications through a PC com port. Follow the instructions below to setup a com port for configuring and testing the RF modem.

Installation #1: X-CTU Software (version 4.8.0 or higher*)

Use the X-CTU software to configure the Ethernet RF Modem and PC com port. The software is divided into four tabs:

- PC Settings tab - Setup PC serial com ports to interface with RF modem
- Range Test tab - Test RF modem's range under varying environments
- Terminal tab - Test serial communications and set/read RF modem parameters
- Modem Configuration tab - Set/read RF modem parameters

Figure 2-02. Tabs of the X-CTU Software

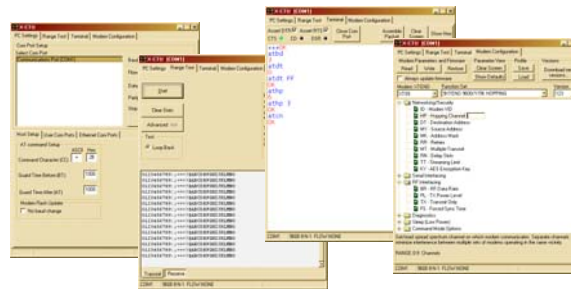

* To verify X-CTU version number, click on the icon located in the top-left corner of the X-CTU user interface and then select the "About X-CTU..." menu item.

To Install the X-CTU Software:

Double-click the "setup_X-CTU.exe" file then follow prompts of the installation screens. This file is located on the MaxStream CD and under the 'Downloads' section of the following web page: www.maxstream.net/helpdesk/download.php.

Installation #2: Ethernet Com Port Redirector

MaxStream provides com port redirection software that creates a com port in the operating system that will forward serial data to the IP address of the Ethernet-connected RF modem. The Ethernet RF Modem can then be accessed as though it were a serial device.

The Ethernet Com Port Redirector must be installed separately to enable the "Ethernet Com Ports" sub-tab of the X-CTU "PC Settings" tab. If this software is not installed, the features under the "Ethernet Com Ports" section are grayed and cannot be used.

The "Ethernet Com Ports" sub-tab enables user to perform functions such as the following:

- Discover Ethernet RF Modems on a network
- Setup serial com ports for XTend-PKG-E Ethernet RF Modems
- Identify, assign and modify Ethernet RF Modem IP addresses

To Install the Ethernet Com Port Redirector:

1. Double-click the "setup_ComPortRedirector.exe" file then follow prompts of the installation screens. This file is located in the "software" folder of the MaxStream CD.
2. Re-boot the PC to complete installation.

2.2.2. Setup Com Port and IP Address

The XTend-PKG-E Ethernet RF Modem supports DHCP (Dynamic Host Configuration Protocol) and Auto IP protocols. Both protocols automatically assign IP addresses to nodes of a network.

Ethernet RF Modem Discovery

The X-CTU Software provides an easy-to-use interface that searches a local network and then displays Ethernet RF Modems found.

Discover Ethernet RF Modem, Map Com Port & Assign IP Address:

1. Install both the X-CTU and the Ethernet Com Port Redirector software [See "Install Software" section on previous page]. Re-boot the PC if prompted to do so.
2. Launch the X-CTU Software and select the PC Settings tab; then select the "Ethernet Com Ports" sub-tab. [Figure 2-03]
--> After the Com Port Redirector is installed (& PC is re-booted), a "Setup Com Port" dialog box will appear the first time the "Ethernet Com Ports" sub-tab is selected. For subsequent uses of the sub-tab, select the 'New IP Address' button and proceed to step 4.
3. Select the 'OK' button.
--> All discovered PKG-E Ethernet RF Modems will be displayed in a new "Assign IP Address" dialog box. [Figure 2-04]
4. Highlight one of the discovered Ethernet RF Modems (Modem IP and Hardware Addresses are listed in the "... discovered Ethernet Modem" section) [Figure 2-04]. If an Ethernet Modem is not discovered, enter the IP address manually in the "Enter IP Address..." box.
5. Select the 'OK' button.
--> Newly assigned Ethernet Modem is listed under the "Ethernet Com Ports" sub-tab and the first available com port is assigned to it. Note that its status is "Queued as new".
6. Select the 'Apply' button [located in the 'Changes' section of the "Ethernet Com Ports" sub-tab - Figure 2-03]. Even if an Ethernet RF Modem appears in the 'Ethernet Com Port' list, the new com port cannot be used until changes are applied and the PC is re-booted.
7. Re-boot the PC; then re-launch the X-CTU Software. The com port can now be used to communicate with the RF modem.

Figure 2-03. Ethernet Com Ports sub-tab
(Ethernet Com Ports sub-tab is enabled by installing the Ethernet Com Port Redirector Software.)

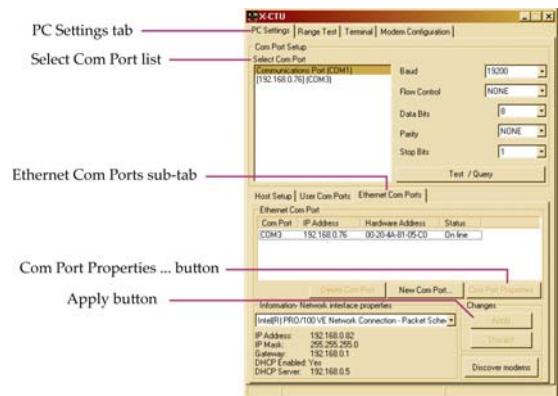
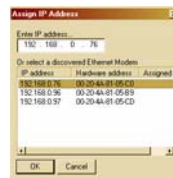

Figure 2-04. Assign IP Address dialog box



NOTE: If the Ethernet RF Modem is left in DHCP mode, it may become necessary to reconfigure a mapped com port any time an IP address is re-assigned by the DHCP server. Dynamic addressing is supported, but assigning a static IP address can simplify the application.

2.2.3. Assign Static IP Address

To assign a static IP address to the Ethernet RF Modem, follow the steps outlined below. A static IP address may be necessary when:

- The Ethernet RF Modem and the host PC are on different subnets
- The Ethernet RF Modem IP address might be changed by a DHCP server

Configure a static IP address on a local network:

1. Install both the X-CTU Software and the Ethernet Com Port Redirector software [See "Com Port Communications" section - p8]. Re-boot the PC if it has not been re-booted since the installation of the Ethernet Com Port Redirector.
2. Launch the X-CTU Software and select the "PC Settings" tab; then select the "Ethernet Com Ports" sub-tab [Figure 2-03]
--> After the Ethernet Com Port Redirector is installed (and PC is re-booted), a "Setup Com Port" dialog box will appear the first time the "Ethernet Com Ports" sub-tab is selected. The following steps are written under the assumption the sub-tab has already been selected at least one time.
3. Select the "Discover modems" button to display which modems are on-line and which are not; then click the 'OK' button of the "Discover Ethernet Modems" dialog box.
4. Click-on and highlight an Ethernet RF Modem from the 'Ethernet Com Ports' list.
5. Select the 'Com Port Properties' button [Figure 2-03].
6. Select the 'Modify' button of the "Properties" dialog box [Figure 2-05].
7. Type a new IP address; then select the 'OK' button [Figure 2-05].
8. Select the 'OK' button of the "Properties" dialog box.
9. Select the 'Apply' button that is under the 'Changes' section of the "Ethernet Com Ports" sub-tab.
--> XTend-PKG-E Ethernet RF Modem re-boots and the new IP Address is saved.

Figure 2-05. Properties & Change IP dialog boxes

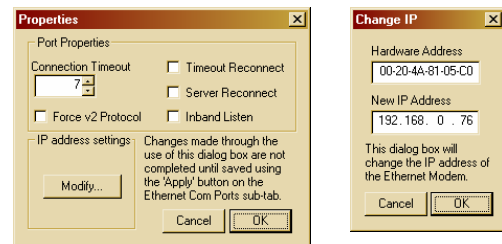

2.2.4. Change Com Port Number

During Com Port Redirector setup, one com port is automatically assigned. Additional com ports are user-assigned. Use the following steps to manually change a com port number:

Change Ethernet RF Modem's Com Port Number:

1. Once the Ethernet RF Modem is recognized and displayed under the "Ethernet Com Ports" sub-tab, select the 'New Com Port' button. Follow the steps outlined in the "Ethernet RF Modem Discovery" section [p9].
2. Type-in the IP Address of the Ethernet Modem and highlight a com port number; then select the 'OK' button.
3. Select the 'Apply' button; then re-boot the PC if prompted to do so.
4. Go to the 'Ethernet Com Ports' sub-tab of the X-CTU Software's 'PC Settings' tab.
5. Highlight the old com port entry, select the 'Delete Com Port' button, then select the 'Apply' button.

2.2.5. Test Communications (X-CTU Loopback)

When testing a wireless link, consider using the following components:

- XTend-PKG-E Ethernet RF Modem (connected to a local network)
- XTend-PKG-R RS-232/485 RF Modem (w/ loopback adapter)
- PC (connected to a local network)
- Accessories (Loopback adapter, CAT5 UTP cable, power supplies and RPSMA antennas)

Hardware Setup for Loopback Test:

1. Connect the XTend-PKG-E (Ethernet) RF Modem and a PC to active Ethernet ports of the same local network using CAT5 cables (included w/ PKG-EA accessories package).
2. Attach the serial loopback adapter to the DB-9 serial connector of the XTend-PKG-R (RS-232) RF Modem. The serial loopback adapter configures the PKG-R RF Modem to function as a repeater by looping serial data back into the modem for retransmission.
3. Configure the PKG-R (RS-232) RF Modem for RS-232 operation using the built-in DIP Switch. Dip Switch 1 should be ON (up) and the remaining switches should be OFF (down).
4. Attach RPSMA antennas to both RF Modems.
5. Power both RF Modems with power supplies (included w/ accessories package).



Figure 2-06. Hardware Setup for Testing a Wireless Link

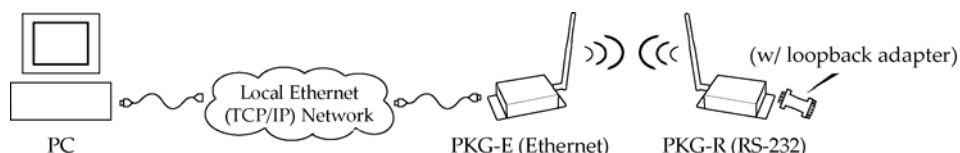

Test Wireless Link (X-CTU Method):

1. Follow the steps in the "Ethernet RF Modem Discovery" section [p9].
2. Setup hardware as shown in the "Hardware Setup..." steps above [Figure 2-06].
3. Select the 'PC Settings' tab of the X-CTU Software; then highlight the Com Port that is forwarded to the PKG-E (Ethernet) RF Modem.
--> Make sure PC com port settings (Baud rate, Parity, etc.) on the "PC Settings" tab match those of the Ethernet RF Modem.
4. Select the 'Terminal' tab of the X-CTU Software.
5. Begin typing characters into the terminal window.
--> Characters typed in the terminal should be echoed back to the screen [Figure 2-07]. Sent characters appear in blue and received characters in red. With each character typed, the 'Data Out' and 'Data In' LEDs should flash briefly on each of the RF Modems.
--> To double-check the wireless link, turn off the power going to the remote PKG-R (RS-232) RF Modem and leave the PKG-E Modem turned on. Type characters into the Terminal Window of the X-CTU Software and note that characters are not echoed back.

Figure 2-07. Terminal Tab of MaxStream's X-CTU Software

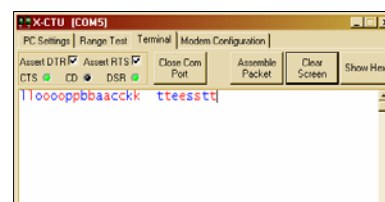

2.3. Telnet Communications

In addition to com port communications, Telnet communications are also supported.

2.3.1. Test Communications (Telnet Loopback)

A wireless link can be tested by connecting to the specific IP address and port number.

Test a Wireless Link (Telnet Connection):

1. Follow steps in the "Ethernet RF Modem Discovery" section [p9].
 2. Setup hardware as shown in the 'Hardware Setup for Loopback Test' section of previous page [Figure 2-06].
 3. If using Windows: Select (Start ' Run); then type "cmd" (without quotation marks) in the text box of the "Run" dialog box. Then select the 'OK' button.
If using Linux or UNIX: Run a command shell.
If using Mac OS X: Run (Applications ' Utilities ' Terminal).
- [Remaining steps are for Microsoft Windows users]
4. At the command prompt, type: telnet xxx.xxx.xxx.xxx 14001 <CR>
("xxx.xxx.xxx.xxx" is the IP address of the Ethernet RF Modem, "14001" is the port number and "<CR>" stands for carriage return or 'Enter' key.) [Figure 2-08]
 5. Begin typing characters into the Telnet session window [Figure 2-09].
--> Characters typed should be echoed back to the screen. With each character typed, the "Data Out" and "Data In" LEDs should flash briefly on each of the PKG RF Modems.
The wireless link can be double-checked by turning off the XTend-PKG-R RS-232/485 RF Modem (leaving the PKG-E Ethernet RF Modem on) and sending characters. When the PKG-R is turned off, characters should not be echoed back.

Figure 2-08. Telnet Interface (connect to PKG-E having an IP address of 192.168.0.168)

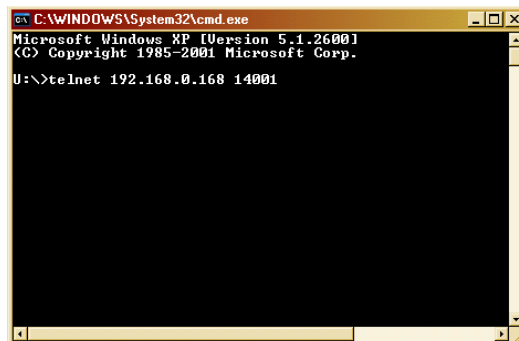
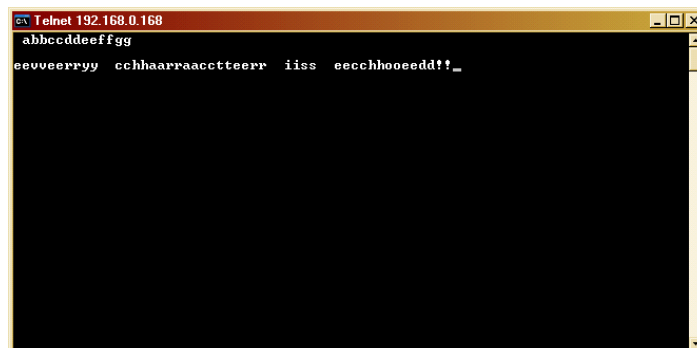

Figure 2-09. Telnet Interface (Sent & Echoed back characters)



3. RF Modem Operation



WARNING: When operating at 1 Watt power output, observe a minimum separation distance of 2' (0.6m) between modems. Transmitting in close proximity of other modems can damage modem front ends.

3.1. Serial Communications

3.1.1. Transparent Operation

By default, XTend RF Modems operate in Transparent Mode. The modems act as a serial line replacement - all UART data received through the DI pin is queued up for RF transmission. When RF data is received, the data is sent out the DO pin.

When the RO (Packetization Timeout) parameter threshold is satisfied, the modem attempts to initialize an RF transmission. If the modem cannot immediately transmit (for instance, if it is already receiving RF data), the serial data continues to be stored in the DI Buffer. Data is packetized and sent at any RO timeout or when the maximum packet size is received.

The modem operates as described above unless the Command Mode Sequence is detected. The Command Mode Sequence consists of three copies of the command sequence character [CC parameter] surrounded by the before and after guard times [BT & AT parameters].

If the DI buffer becomes full, hardware or software flow control must be implemented in order to prevent overflow (loss of data between the host and modem).

3.1.2. API Operation

API (Application Programming Interface) Operation is an alternative to the default Transparent Operation. The API is frame-based and extends the level to which a host application can interact with the networking capabilities of the module. When in API mode, all data entering and leaving the RF modem is contained in frames that define operations or events within the modem.

Transmit Data Frames (received through the DI (Data In) pin) include:

- 16-bit address

Receive Data Frames (sent out the DO (Data Out) pin) include:

- Showing a received RF packet (16 bits only)
- Response to a TX (Transmit) packet
- Showing events such as hardware reset, watchdog reset, asynchronous events, etc.

The modem will send data frames to the application containing status packets; as well as source, RSSI and payload information from received data packets.

API operation option facilitates many operations such as the examples cited below:

- > Change destination addresses without having to enter command mode
- > Receive success/failure status of each RF packet
- > Identify the source address of each received packet

To implement API operations, refer to 'API Operation' sections [p42].

3.2. Modes of Operation

XTend RF Modems operate in five modes.

Figure 3-01. Modes of Operation

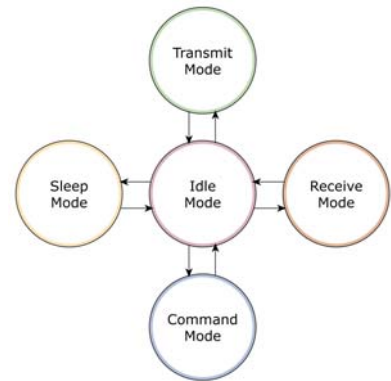

3.2.1. Idle Mode

When not receiving or transmitting data, the RF modem is in Idle Mode. The modem shifts into the other modes of operation under the following conditions:

- Transmit Mode (Serial data is received in the DI Buffer)
- Receive Mode (Valid RF data is received through the antenna)
- Sleep Mode (Sleep Mode condition is met)
- Command Mode (Command Mode Sequence is issued)

3.2.2. Transmit Mode

When the first byte of serial data is received from the UART in the DI buffer, the modem attempts to shift to Transmit Mode and initiate an RF connection with other modems. After transmission is complete, the modem returns to Idle Mode.

RF transmission begins after either of the following criteria is met:

1. RB bytes have been received by the UART and are pending for RF transmission. [Refer to the RB (Packetization Threshold) Command]
2. At least one character has been received by the UART and is pending for RF transmission; and RO character times of silence been observed on the UART. [Refer to the RO (Packetization Timeout) Command]

Figure 3-02. Transmit Mode Data Flow

The character timeout trigger can be disabled by setting RO to zero. In this case, transmission will not begin until RB bytes have been received and are pending for RF transmission. The RB parameter may be set to any value between 1 and the RF packet size [refer to PK (Max RF Packet Size) parameter], inclusive. Note that transition to Transmit Mode cannot take place during RF reception; the RF reception must complete before the radio can transition into Transmit Mode.

If RB or RO conditions are met, the modem initializes a communications channel. Serial data in the DI buffer is grouped into RF packets (up to 2048 bytes in each packet, refer to PK Command), converted to RF data and is transmitted over-the-air until the DI buffer is empty.

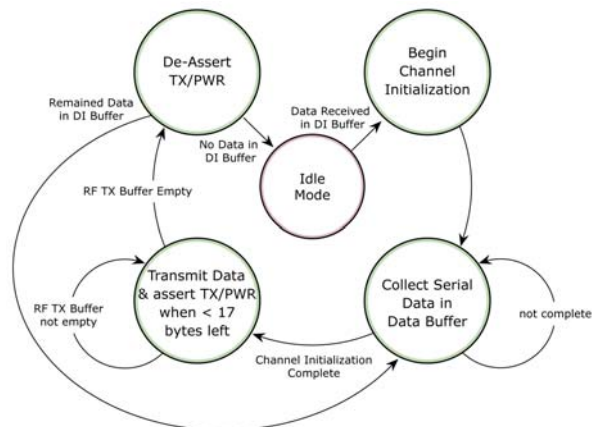

Channel initialization is the process of sending an RF initializer that synchronizes receiving modems with the transmitting modem. During channel initialization, incoming serial data accumulates in the DI buffer.

RF data, which includes the payload data, follows the RF initializer. The payload includes up to the maximum packet size (PK Command) bytes. As the TX modem nears the end of the transmission, it inspects the DI buffer to see if more data exists to be transmitted. This could be the case if more than PK bytes were originally pending in the DI buffer or if more bytes arrived from the UART after the transmission began. If more data is pending, the transmitting modem assembles a subsequent packet for transmission.

Refer to the 'RF Communication Modes' section to view state diagrams that illustrate channel initialization and the sequence of events that follow.

RF Packet

Figure 3-03. RF Packet Components

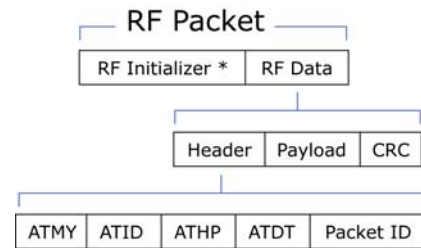

* When streaming multiple RF packets, the RF Initializer is only sent in front of the first packet.

RF Initializer

An RF initializer is sent each time a new connection sequence begins. The RF initializer contains channel information that notifies receiving modems of information such as the hopping pattern used by the transmitting modem. The first transmission always sends an RF initializer.

An RF initializer can be of various lengths depending on the amount of time determined to be required to prepare a receiving modem. For example, a wake-up initializer is a type of RF initializer used to wake remote modems from Sleep Mode (Refer to the FH, LH, HT and SM Commands for more information). The length of the wake-up initializer should be longer than the length of time remote modems are in cyclic sleep.

Header

The header contains network addressing information that filters incoming RF data. The receiving modem checks for matching a Hopping Channel, VID and Destination Address. Data that does not pass through all three network filter layers is discarded.

Refer to the 'Addressing' section of the "RF Communication Modes" chapter for more information.

CRC (Cyclic Redundancy Check)

To verify data integrity and provide built-in error checking, a 16-bit CRC (Cyclic Redundancy Check) is computed for the transmitted data and attached to the end of each RF packet. On the receiving end, the receiving modem computes the CRC on all incoming RF data. Received data that has an invalid CRC is discarded [refer to the 'Receive Mode' section].

3.2.3. Receive Mode

If a modem detects RF data while operating in Idle Mode, the modem transitions to Receive Mode to start receiving RF packets. Once a packet is received, the modem checks the CRC (cyclic redundancy check) to ensure that the data was transmitted without error. If the CRC data bits on the incoming packet are invalid, the packet is discarded. If the CRC is valid, the packet proceeds to the DO Buffer.

Figure 3-04. Receive Mode Data Flow

* Refer to the 'Address Recognition' section for more information regarding address recognition.

The modem returns to Idle Mode when valid RF data is no longer detected or after an error is detected in the received RF data. If serial data is stored in the DI buffer while the modem is in Receive Mode, the serial data will be transmitted after the modem is finished receiving data and returns to Idle Mode.

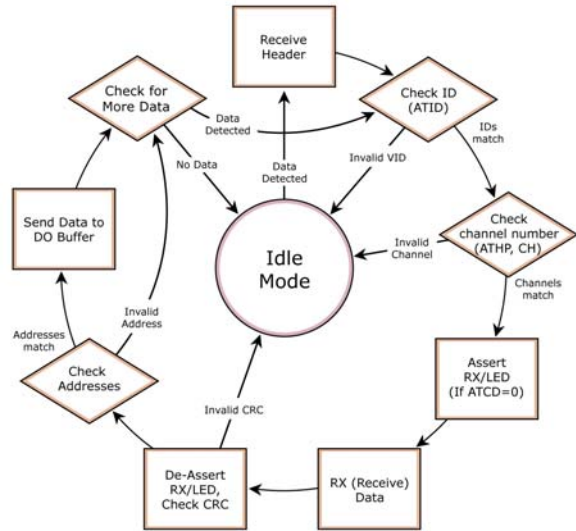

3.2.4. Sleep Mode

Software Sleep

Sleep Modes enable the modem to enter states of low-power consumption when not in use. Three software Sleep Modes are supported:

- Serial Port Sleep (Wake on Serial Port activity)
- Cyclic Sleep (Wake on RF activity)

In order to enter Sleep Mode, the following condition must be met (in addition to the modem having a non-zero SM parameter value):

The modem is idle (no data transmission or reception) for the amount of time defined by the ST (Time before Sleep) parameter. [NOTE: ST is only active when SM = 4-5.]

When in Sleep Mode, the modem will not transmit or receive data until the modem first transitions to Idle Mode. All Sleep Modes are enabled and disabled using SM Command. Transitions into and out of Sleep Modes are triggered by various mechanisms as shown in the table below.

Table 3-01. Summary of Sleep Mode Configurations

Sleep Mode (Setting)	Transition into Sleep Mode	Transition out of Sleep Mode (wake)	Related Commands	Power Consumption
Serial Port Sleep (SM = 2)	Automatic transition to Sleep Mode occurs after a user-defined period of inactivity (no transmitting or receiving of data). Period of inactivity is defined by the ST (Time before Sleep) Command.	When a serial byte is received on the DI pin	(SM), ST	< 210 mA
Cyclic Sleep (SM = 4 - 8)	RF modem transitions in and out of Sleep Mode in cycles (user-selectable wake-up interval of time is set using the SM command). The cyclic sleep interval of time must be shorter than the interval of time that is defined by the LH (Wake-up Initializer Timer) command. Note: The modem can be forced into Idle Mode using the SLEEP pin if the PW (Pin Wake-up) command is issued.		(SM), ST, HT, LH, PW	< 210 - 224 mA when sleeping (SM=4, 1 sec., @120K baud)

The SM (Sleep Mode) command is central to setting all Sleep Mode configurations. By default, Sleep Modes are disabled (SM = 0) and the modem remains in Idle/Receive Mode. When in this state, the modem remains constantly ready to respond to serial or RF activity.

Serial Port Sleep (SM = 2)

- Wake on serial port activity
- Typical power-down current: < 210 mA

Serial Port Sleep is a Sleep Mode in which the modem runs in a low power state until serial data is detected on the DI pin.

The period of time the modem sleeps is determined by ST (Time before Sleep) Command. Once a character is received through the DI pin, the modem returns to Idle Mode and is fully operational.

Cyclic Sleep (SM = 4-8)

- Typical Power-down Current: < 210 - 224 mA (when asleep)

Cyclic Sleep Modes allow modems to periodically wake and check for RF data. The modem wakes according to the times designated by the Cyclic sleep settings. If the modem detects a wake-up initializer during the time it is awake, the modem synchronizes with the transmitting modem and receives data after the wake-up initializer runs its duration. Otherwise, the modem returns to Sleep Mode and continues to cycle in and out of activity until a wake-up initializer is detected.

While the modem is in Cyclic Sleep Mode, $\overline{\text{CTS}}$ (GPO1) is de-asserted (high) to indicate that data should not be sent to the modem. When the modem awakens to listen for data, GPO1 is asserted and any data received on the DI Pin is transmitted. The PWR pin is also de-asserted (low) when the modem is in Cyclic Sleep Mode.

The modem remains in Sleep Mode for a user-defined period of time ranging from 0.5 seconds to 16 seconds (SM parameters 4 through 8). After this interval of time, the modem returns to Idle Mode and listens for a valid data packet for 100 ms. If the modem does not detect valid data (on any frequency), the modem returns to Sleep Mode. If valid data is detected, the modem transitions into Receive Mode and receives the incoming RF packets. The modem then returns to Sleep Mode after a period of inactivity determined by the ST "Time before Sleep" parameter.

The modem can also be configured to wake from cyclic sleep when the SLEEP pin is de-asserted. To configure a modem to operate in this manner, PW (Pin Wake-up) Command must be issued. Once the SLEEP pin is de-asserted, the modem is forced into Idle Mode and can begin transmitting or receiving data. It remains active until data is no longer detected for the period of time specified by the ST Command, at which point it resumes its low-power cyclic state.

Cyclic Scanning. Each RF transmission consists of an RF Initializer and payload. The RF initializer contains initialization information and all receiving modems must wake during the wake-up initializer portion of data transmission in order to be synchronized with the transmitting modem and receive the data.

The cyclic interval time defined by SM (Sleep Mode) Command must be shorter than the interval time defined by LH (Wake-up Initializer Timer).

3.2.5. Command Mode

To modify or read modem parameters, the modem must first enter into Command Mode (state in which incoming characters are interpreted as commands). Two command types are supported:

- AT Commands
- Binary Commands

For modified parameter values to persist in the modem registry, changes must be saved to non-volatile memory using the WR (Write) command. Otherwise, parameters are restored to previously saved values when the modem is powered off and then on again.

AT Command Mode

To Enter AT Command Mode:

1. Send the 3-character command sequence "+++" and observe guard times before and after the command characters. [refer to 'Default AT Command Mode Sequence' below.] The 'Terminal' tab (or other serial communications software) of the X-CTU Software can be used to enter the sequence.
[OR]
2. Assert (low) the CONFIG pin and turn the power going to the modem off and back on (or pulse the SHDN pin).
[If the modem is mounted to a MaxStream RS-232/485 Interface Board, the result can be achieved by pressing the configuration switch down for 2 seconds.]

Default AT Command Mode Sequence (for transition to Command Mode):

- No characters sent for one second [refer to the BT (Guard Time Before) Command]
- Input three plus characters ("+++") within one second [refer to the CC (Command Sequence Character) Command.]
- No characters sent for one second [refer to the AT (Guard Time After) Command.]

All of the parameter values in the sequence can be modified to reflect user preferences.

To Send AT Commands:

Send AT commands and parameters using the syntax shown below.

Figure 3-05. Syntax for sending AT Commands

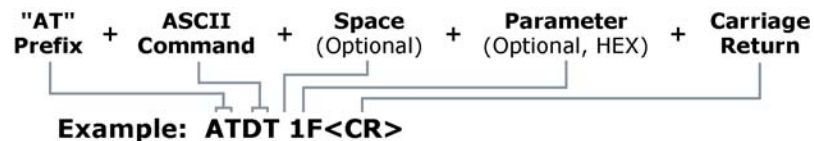

To read a parameter value stored in the modem register, leave the parameter field blank.

The preceding example would change the modem's Destination Address to "0x1F". To store the new value to non-volatile (long term) memory, the Write (ATWR) command must subsequently be sent before powering off the modem.

System Response. When a command is sent to the modem, the modem will parse and execute the command. Upon successful execution of a command, the modem returns an "OK" message. If execution of a command results in an error, the modem returns an "ERROR" message.

To Exit AT Command Mode:

1. If no valid AT Commands are received within the time specified by CT (Command Mode Timeout) Command, the modem automatically returns to Idle Mode.
[OR]
2. Send ATCN (Exit Command Mode) Command.

For an example of programming the RF modem using AT Commands and descriptions of each configurable parameter, refer to the "RF Modem Configuration" chapter [p20].

Binary Command Mode

Sending and receiving parameter values using binary commands is the fastest way to change operating parameters of the modem. Binary commands are used most often to sample signal strength [refer to DB (Received Signal Strength) parameter] and/or error counts; or to change modem addresses and channels for polling systems when a quick response is necessary. Since the sending and receiving of parameter values takes place through the same serial data path as 'live' data (received RF payload), interference between the two types of data can be a concern.

Common questions about using binary commands:

- What are the implications of asserting CMD while live data is being sent or received?
- After sending serial data, is there a minimum time delay before CMD can be asserted?
- Is a time delay required after CMD is de-asserted before payload data can be sent?
- How does one discern between live data and data received in response to a command?

The CMD pin (GPI1) must be asserted in order to send binary commands to the modem. The CMD pin can be asserted to recognize binary commands anytime during the transmission or reception of data. The status of the CMD signal is only checked at the end of the stop bit as the byte is shifted into the serial port. The application does not allow control over when data is received, except by waiting for dead time between bursts of communication.

If the command is sent in the middle of a stream of payload data to be transmitted, the command will essentially be executed in the order it is received. If the modem is continuously receiving data, the radio will wait for a break in the received data before executing the command. The $\overline{\text{CTS}}$ signal will frame the response coming from the binary command request [refer to figure below].

A minimum time delay of 100 μs (after the stop bit of the command byte has been sent) must be observed before the CMD pin can be de-asserted. The command executes after all parameters associated with the command have been sent. If all parameters are not received within 0.5 seconds, the modem returns to Idle Mode.

Note: When parameters are sent, they are two bytes long with the least significant byte sent first. Binary commands that return one parameter byte must be written with two parameter bytes.

Commands can be queried for their current value by sending the command logically ORed (bit-wise) with the value 0x80 (hexadecimal) with CMD asserted. When the binary value is sent (with no parameters), the current value of the command parameter is sent back through the DO pin.

Figure 3-06. Binary Command Write then Read

Signal #4 is CMD

Signal #1 is the DI signal

Signal #2 is the DO signal from the radio

Signal #3 is $\overline{\text{CTS}}$

In this graph, a value was written to a register and then read out to verify it. While not in the middle of other received data, note that the $\overline{\text{CTS}}$ signal outlines the data response out of the modem.

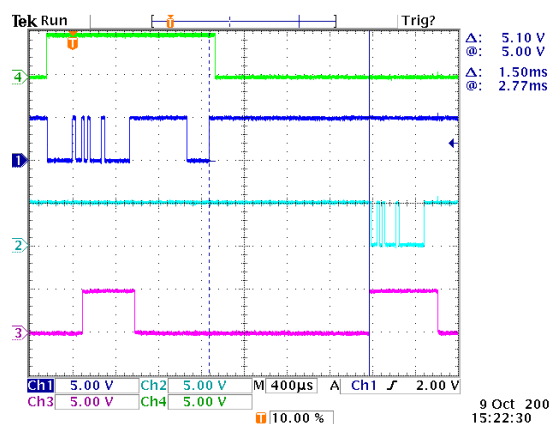

IMPORTANT: In order for the modem to recognize a binary command, the RT (GPI1 Configuration) parameter must be set to one. If binary programming is not enabled (RT parameter value is not equal to '1'), the modem will not recognize that the CMD pin is asserted and therefore will not recognize the data as binary commands.

Refer to [p21] for a binary programming example (DT command example returns two bytes).

4. RF Modem Configuration

4.1. Programming Examples

Refer to the 'Command Mode' section [p18] for information regarding entrance into Command Mode, sending AT commands and exiting Command Mode.

Examples in this section cite the use of MaxStream's X-CTU Software for programming the RF modem. Other programs such as Telnet Software can also be used to program the modem.

4.1.1. Configuration Setup Options

After installing the X-CTU and Com Port Redirector Software [p8] to a PC, use one of the connection options below to send commands to the XTend-PKG-E Ethernet RF Modem.

Option #1 - Local Network Connection

Connect a PC and the Ethernet RF Modem to active Ethernet connections of the same local network [as shown in the figure below].

Figure 4-01. Local Network Connection

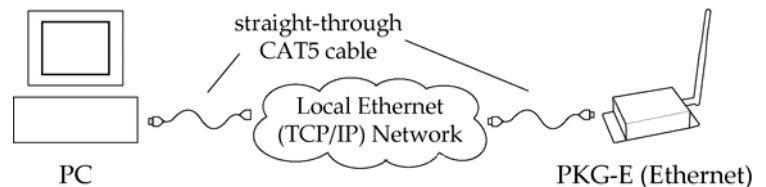

Option #2 - Direct PC Connection

Connect the Ethernet RF Modem directly to the PC through the PC's Ethernet port [as shown in the figure below].

Figure 4-02. Direct PC Connection

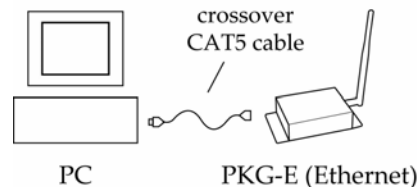

Configuration Setup:

1. Install both the X-CTU Software and the Ethernet Com Port Redirector [See 'Install Software' [p8] section for more information].
2. Connect the Ethernet RF Modem to a PC using either a Local Network [Figure 4-01] or a Direct PC [Figure 4-02] connection.
3. Follow the steps outlined in the 'Ethernet RF Modem Discovery' section [p9] to identify the com port that will be used to configure the RF modem.
4. Launch the X-CTU Software on the PC and select the PC Settings tab.
5. Make sure values shown in the fields of the 'Com Port Setup' section match those of the Ethernet RF Modem.

[Example is continued on the following page.]

4.1.2. AT Command Examples

Terminal Tab (X-CTU Software)

A terminal program has been built into the X-CTU software and is located under the 'Terminal' tab. The Terminal tab provides an easy-to-use interface for programming the modem.

System Response. When a command is sent to the modem, the modem will parse and execute the command. Upon successful execution of a command, the modem returns an "OK" message. If execution of a command results in an error, the modem returns an "ERROR" message.

Restore RF Modem Default Parameters (Using the 'Terminal' tab of the X-CTU Software)

Example: Both of the following examples restore the XTend Modem's factory defaults and save the parameters to non-volatile memory.

Method 1 (One line per command)

Send AT Command	System Response
+++	OK <CR> (Enter into Command Mode)
ATRE <Enter>	OK <CR> (Restore RF modem default parameter values)
ATWR <Enter>	OK <CR> (Write to non-volatile memory)
ATCN <Enter>	OK <CR> (Exit Command Mode)

Method 2 (Multiple commands on one line)

Send AT Command	System Response
+++	OK <CR> (Enter into Command Mode)
ATRE, WR <Enter>	OK <CR> (Execute multiple commands)
ATCN <Enter>	OK (Exit AT Command Mode)

Note: Do not send commands to the modem during flash programming (when parameters are being written to the modem registry).

Wait for the "OK" system response that follows the ATWR command before entering the next command or use flow control.

NOTE: Default parameter values of the RF Modem can also be restored by selecting the 'Restore' button located on the "Modem Configuration" tab [refer to the example below].

Modem Configuration Tab

Sample Configuration: Restore RF Modem Defaults

Example: Utilize the X-CTU "Modem Configuration" tab to restore default parameter values. After establishing a connection between the modem and a PC [refer to the 'Setup' section above], select the "Modem Configuration" tab of the X-CTU Software.

1. Select the 'Read' button.
2. Select the 'Restore' button.

4.1.3. Binary Command Example

To Send Binary Commands:

Example: Use binary commands to change the RF modem's destination address to 0x1A0D and save the new address to non-volatile memory.

1. RT Command must be set to '1' in AT Command Mode to enable binary programming.
2. Assert CMD (Pin 10 is driven high). (Enter Binary Command Mode)
3. Send Bytes [parameter bytes must be 2 bytes long]:

00	(Send DT (Destination Address) Command)
0D	(Least significant byte of parameter bytes)
1A	(Most significant byte of parameter bytes)
08	(Send WR (Write) Command)
4. De-assert CMD (GPI1 is driven low). (Exit Binary Command Mode)

Note: \overline{CTS} (GPO1) is high when a command is being executed. Hardware flow control must be disabled as \overline{CTS} will hold off parameter bytes.

4.2. Command Reference Table

Table 4-01. XTend Commands (The RF modems expect numerical values in hexadecimal. Hexadecimal values are designated by a “0x” prefix. Decimal equivalents are designated by a “d” suffix.)

AT Command	Binary Command	AT Command Name	Parameter Range	Command Category	# Bytes Returned	Factory Default
%V	0x3B (59d)	Board Voltage	0x2CCCA - 0x5BFFA [read-only]	Diagnostics	4	--
AM	0x40 (64d)	Auto-set MY	--	Networking & Security	--	--
AP v2.x20*	--	API Enable	0 - 2	Serial Interfacing	1	0
AT	0x05 (5d)	Guard Time After	2 - (ATST-3) [x 100 msec]	Command Mode Options	2	0x0A (10d)
BD	0x15 (21d)	Interface Data Rate	0 - 8 (standard rates) 0x39 - 0x1C9C38 (non-standard rates)	Serial Interfacing	4	3
BR	0x39 (57d)	RF Data Rate	0 - 1	RF Interfacing	1	1
BT	0x04 (4d)	Guard Time Before	0 - 0xFFFF [x 100 msec]	Command Mode Options	2	0x0A (10d)
CC	0x13 (19d)	Command Sequence Character	0x20 - 0x7F	Command Mode Options	1	0x2B [“+”] (43d)
CD	0x28 (40d)	GPO2 Configuration	0 - 4	Serial Interfacing	1	2
CF	--	Number Base	0 - 2	Command Mode Options	1	1
CN	0x09 (9d)	Exit Command Mode	--	Command Mode Options	--	--
CS	0x1F (31d)	GPO1 Configuration	0 - 4	Serial Interfacing	1	0
CT	0x06 (6d)	Command Mode Timeout	2 - 0xFFFF [x 100 ms]	Command Mode Options	2	0xC8 (200d)
DB	0x36 (54d)	Received Signal Strength	0x6E - 0x28 [read-only]	Diagnostics	2	--
DT	0x00 (0d)	Destination Address	0 - 0xFFFF	Networking & Security	2	0
E0	0x0A (10d)	Echo Off	--	Command Mode Options	--	--
E1	0x0B (11d)	Echo On	--	Command Mode Options	--	--
ER	0x0F (15d)	Receive Error Count	0 - 0xFFFF	Diagnostics	2	0
FH	0x0D (13d)	Force Wake-up Initializer	--	Sleep (Low Power)	--	--
FL	0x07 (7d)	Software Flow Control	0 - 1	Serial Interfacing	1	0
FS	0x3E (62d)	Forced Sync Time	0 - 0xFFFF [x 10 msec]	RF Interfacing	2	0
FT	0x24 (36d)	Flow Control Threshold	0 - (DI buffer size - 0x11) [Bytes]	Serial Interfacing	2	DI buffer size minus 0x11
GD	0x10 (16d)	Receive Good Count	0 - 0xFFFF	Diagnostics	2	0
HP	0x11 (17d)	Hopping Channel	0 - 9	Networking & Security	1	0
HT	0x03 (3d)	Time before Wake-up Initializer	0 - 0xFFFF [x 100 msec]	Sleep (Low Power)	2	0xFFFF (65535d)
HV	--	Hardware Version	0 - 0xFFFF [read-only]	Diagnostics	2	--
ID	0x27 (39d)	Modem VID	0x11 - 0x7FFF (user-settable) 0x8000 - 0xFFFF (factory-set, read-only)	Networking & Security	2	0x3332 (13106d)
KY	0x3C (60d)	AES Encryption Key	0 - (Any other 64-digit hex valid key)	Networking & Security	2	0
LH	0x0C (12d)	Wake-up Initializer Timer	0 - 0xFF [x 100 msec]	Sleep (Low Power)	1	1
MD v2.x20*	0x31 (49d)	RF Mode	0 - 6	Networking & Security	1	0
MK	0x12 (18d)	Address Mask	0 - 0xFFFF	Networking & Security	2	0xFFFF (65535d)
MT	0x3D (61d)	Multi-Transmit	0 - 0xFF	Networking & Security	1	0
MY	0x2A (42d)	Source Address	0 - 0xFFFF	Networking & Security	2	0xFFFF (65535d)
NB	0x23 (35d)	Parity	0 - 4	Serial Interfacing	1	0
PB v2.x20*	0x45 (69d)	Polling Begin Address	0 - 0xFFFF	Networking & Security	2	0
PD v2.x20*	0x47 (71d)	Minimum Polling Delay	0 - 0xFFFF (Base: (x 1 ms), Remote: [x 10 ms])	Networking & Security	2	0
PE v2.x20*	0x46 (70d)	Polling End Address	0 - 0xFFFF	Networking & Security	2	0

Table 4-01. XTend Commands (The RF modems expect numerical values in hexadecimal. Hexadecimal values are designated by a “0x” prefix. Decimal equivalents are designated by a “d” suffix.)

AT Command	Binary Command	AT Command Name	Parameter Range	Command Category	# Bytes Returned	Factory Default
PK	0x29 (41d)	Maximum RF Packet Size	1 - 0x800 [Bytes]	RF Interfacing	2	varies
PL	0x3A (58d)	TX Power Level	0 - 4	RF Interfacing	1	4 (1 Watt)
PW	0x1D (29d)	Pin Wake-up	0 - 1	Sleep (Low Power)	1	0
RB	0x20 (32d)	Packetization Threshold	1 - Current value of PK	Serial Interfacing	2	0x800 (2048d)
RC	--	Ambient Power - Single Channel	0 - 0x31 [dBm, read-only]	Diagnostics	1	--
RE	0x0E (14d)	Restore Defaults	--	(Special)	--	--
RM	--	Ambient Power - All Channels	No parameter - 0x7D0	Diagnostics	2	--
RN	0x19 (25d)	Delay Slots	0 - 0xFF [slots]	Networking & Security	1	0
RO	0x21 (33d)	Packetization Timeout	0 - 0xFFFF [x UART character time]	Serial Interfacing	2	3
RP	0x22 (34d)	RSSI PWM Timer	0 - 0xFF [x 100 msec]	Diagnostics	1	0x20 (32d)
RR	0x18 (24d)	Retries	0 - 0xFF	Networking & Security	1	0x0A (10d)
RT	0x16 (22d)	GPIO Configuration	0 - 2	Serial Interfacing	1	0
SB	0x37 (55d)	Stop Bits	0 - 1	Serial Interfacing	1	0
SH	0x25 (37d)	Serial Number High	0 - 0xFFFF [read-only]	Diagnostics	2	varies
SL	0x26 (38d)	Serial Number Low	0 - 0xFFFF [read-only]	Diagnostics	2	varies
SM	0x01 (1d)	Sleep Mode	0 - 8 (3 is reserved)	Sleep (Low Power)	1	0
ST	0x02 (2d)	Time before Sleep	(ATAT+3) - 0x7FFF [x 100 msec]	Sleep (Low Power)	2	0x64 (100d)
TP	0x38 (56d)	Board Temperature	0 - 0x7F [read-only]	Diagnostics	1	--
TR	0x1B (27d)	Delivery Failure Count	0 - 0xFFFF [read-only]	Diagnostics	2	0
TT	0x1A (26d)	Streaming Limit	0 - 0xFFFF [0 = disabled]	Networking & Security	2	0
TX	0x3F (63d)	Transmit Only	0 - 1	RF Interfacing	1	0
VL	--	Firmware Version - verbose	Returns string	Diagnostics	--	--
VR	0x14 (20d)	Firmware Version	0 - 0xFFFF [read-only]	Diagnostics	2	--
WA	--	Active Warning Numbers	Returns string	Diagnostics	--	--
WN	--	Warning Data	Returns string	Diagnostics	--	--
WR	0x08 (8d)	Write	--	(Special)	--	--
WS	--	Sticky Warning Numbers	Returns string	Diagnostics	--	--

* Firmware version in which command and parameter options were first supported

4.3. Command Descriptions

Commands in this section are listed alphabetically. Command categories are designated between the "< >" symbols that follow each command title. By default, XTend RF Modems expect numerical values in hexadecimal since the default value of the CF (Number Base) Parameter is '1'. Hexadecimal values are designated by the "0x" prefix and decimal values by the "d" suffix.

%V (Board Voltage) Command

<Diagnostics> %V Command is used to read the current voltage of the modem circuit board.

Sample Output:

5.02 V (when ATCF = 0)
5051F (when ATCF = 1) *
5.02 (when ATCF = 2)

* When CF = 1 (default), a hex integer is shown that is equal to (voltage * 65536d).

AT Command: AT%V

Binary Command: 0x3B (59 decimal)

Parameter Range (read-only):
0x2CCCA – 0x5BFFA
(2.80 – 5.75 decimal)

Number of bytes returned: 4

AM (Auto-set MY) Command

<Networking & Security> AM Command is used to automatically set the MY (Source Address) parameter from the factory-set serial number of the modem. The address is formed with bits 29, 28 and 13-0 of the serial number (in that order). The resulting value is displayed as a result of this command.

AT Command: ATAM

Binary Command: 0x40 (64 decimal)

AP (API Enable) Command

<Serial Interfacing> The AP command is used to enable the modem to operate using the frame-based API operation.

AT Command: ATAP

Parameter Range: 0 – 2

Parameter	Configuration
0	API Disabled (Transparent Operation)
1	API enabled (w/out escaped characters)
2	API enabled (with escaped characters)

Default Parameter Value:0

Number of Bytes Returned:1

Minimum Firmware Version Required: 2.x20

AT (Guard Time After) Command

<Command Mode Options> AT Command is used to set/read the time-of-silence that follows the command sequence character (CC Command) of the AT Command Mode Sequence (BT + CC + AT). By default, 1 second must elapse before and after the command sequence character.

The times-of-silence surrounding the command sequence character are used to prevent inadvertent entrance into AT Command Mode.

AT Command: ATAT

Binary Command: 0x05 (5 decimal)

Parameter Range: 2 – (ATST–3), up to 0x7FFC
[x 100 milliseconds]

Default Parameter Value: 0x0A (10 decimal)

Number of bytes returned: 2

Related Commands: BT (Guard Time Before),
CC (Command Sequence Character)

BD (Interface Data Rate) Command

<Serial Interfacing> The BD command is used to set and read the serial interface data rate (baud rate) used between the RF modem and host. This parameter determines the rate at which serial data is sent to the modem from the host. Modified interface data rates do not take effect until the CN (Exit AT Command Mode) command is issued and the system returns the 'OK' response.

When parameters 0-8 are sent to the modem, the respective interface data rates are used (as shown in the table on the right).

The RF data rate is not affected by the BD parameter. If the interface data rate is set higher than the RF data rate, a flow control configuration may need to be implemented.

The range between standard and non-standard baud rates (0x09 - 0x38) is invalid.

Non-standard Interface Data Rates:

Any value above 0x38 will be interpreted as an actual baud rate. When a value above 0x38 is sent, the closest interface data rate represented by the number is stored in the BD register. For example, a rate of 19200 bps can be set by sending the following command line "ATBD4B00". NOTE: When using MaxStream's X-CTU Software, non-standard interface data rates can only be set and read using the X-CTU 'Terminal' tab. Non-standard rates are not accessible through the 'Modem Configuration' tab.

When the BD command is sent with a non-standard interface data rate, the UART will adjust to accommodate the requested interface rate. In most cases, the clock resolution will cause the stored BD parameter to vary from the parameter that was sent (refer to the table below). Reading the BD command (send "ATBD" command without an associated parameter value) will return the value actually stored in the modem's BD register.

Parameters Sent Versus Parameters Stored

BD Parameter Sent (HEX)	Interface Data Rate (bps)	BD Parameter Stored (HEX)
0	1200	0
4	19,200	4
7	115,200	7
12C	300	12B
1C200	115,200	1B207

BR (RF Data Rate) Command

<RF Interfacing> The BR command is used to set and read the RF data rate (rate that RF data is transmitted over-the-air) of the modem.

AT Command: ATBD

Binary Command: 0x15 (21 decimal)

Parameter Ranges: 0 – 8 (standard rates)
0x39 – 0x1C9C38 (non-standard rates)

Parameter	Configuration (bps)
0	1200
1	2400
2	4800
3	9600
4	19200
5	38400
6	57600
7	115200
8	230400

Default Parameter Value: 3

Non-standard baud rates supported as of firmware v2.x20

Number of bytes returned: 4

AT Command: ATBR

Binary Command: 0x39 (57 decimal)

Parameter Range: 0 – 1

Parameter	Baud (bps) Configuration
0	9600
1	115200

Default Parameter Value: 1

Number of bytes returned: 1

BT (Guard Time Before) Command

<AT Command Mode Options> The CC command is used to set/read the ASCII character used between guard times of the AT Command Mode Sequence (BT + CC + AT). This sequence enters the modem into AT Command Mode so that data entering the modem (from the host) is recognized as commands instead of payload.

AT Command: ATCC
Binary Command: 0x13 (19 decimal)
Parameter Range: 0x20 – 0x7F
Default Parameter Value: 0x2B (ASCII "+")
Number of bytes returned: 1
Related Commands: AT (Guard Time After), BT (Guard Time Before)

CC (Command Sequence Character) Command

<AT Command Mode Options> The CC command is used to set/read the ASCII character used between guard times of the AT Command Mode Sequence (BT + CC + AT). This sequence enters the modem into AT Command Mode so that data entering the modem (from the host) is recognized as commands instead of payload.

AT Command: ATCC
Binary Command: 0x13 (19 decimal)
Parameter Range: 0x20 – 0x7F
Default Parameter Value: 0x2B (ASCII "+")
Number of bytes returned: 1
Related Commands: AT (Guard Time After), BT (Guard Time Before)

CD (GPO2 Configuration) Command

<Serial Interfacing> CD Command is used to select/read the behavior of the GPO2 line (pin 3).

AT Command: ATCD												
Binary Command: 0x28 (40 decimal)												
Parameter Range: 0 – 8 (standard rates)												
<table border="1"> <thead> <tr><th>Parameter</th><th>Configuration</th></tr> </thead> <tbody> <tr><td>0</td><td>RX LED</td></tr> <tr><td>1</td><td>Default High</td></tr> <tr><td>2</td><td>Default Low</td></tr> <tr><td>3</td><td>(reserved)</td></tr> <tr><td>4</td><td>RX LED (valid address only)</td></tr> </tbody> </table>	Parameter	Configuration	0	RX LED	1	Default High	2	Default Low	3	(reserved)	4	RX LED (valid address only)
Parameter	Configuration											
0	RX LED											
1	Default High											
2	Default Low											
3	(reserved)											
4	RX LED (valid address only)											
Default Parameter Value: 2												
Number of bytes returned: 1												

CF (Number Base) Command

<Command Mode Options> CF command is used to set/read the command formatting setting.

The following commands are always entered and read in hex, no matter the CF setting:

- VR (Firmware Version)
- HV (Hardware Version)
- KY (AES Encryption Key)

AT Command: ATCF								
Parameter Range: 0 – 2								
<table border="1"> <thead> <tr><th>Parameter</th><th>Configuration</th></tr> </thead> <tbody> <tr><td>0</td><td>Commands utilize default number base; decimal commands may output units</td></tr> <tr><td>1</td><td>All commands forced to unsigned, unit-less hex</td></tr> <tr><td>2</td><td>Commands utilize their default number base; no units are output</td></tr> </tbody> </table>	Parameter	Configuration	0	Commands utilize default number base; decimal commands may output units	1	All commands forced to unsigned, unit-less hex	2	Commands utilize their default number base; no units are output
Parameter	Configuration							
0	Commands utilize default number base; decimal commands may output units							
1	All commands forced to unsigned, unit-less hex							
2	Commands utilize their default number base; no units are output							
Default Parameter Value: 1								
Number of bytes returned: 1								

CN (Exit AT Command Mode) Command

<Command Mode Options> The CN command is used to explicitly exit the modem from AT Command Mode.

AT Command: ATCN

Binary Command: 0x09 (9 decimal)

CS (GPO1 Configuration) Command

<Serial Interfacing> CS Command is used to select the behavior of the GPO1 pin (pin 9). This output can provide RS-232 flow control, control the TX enable signal (for RS-485 or RS-422 operations).

By default, GPO1 provides RS-232 $\overline{\text{CTS}}$ (Clear-to-Send) flow control.

AT Command: ATCS

Binary Command: 0x1F (31 decimal)

Parameter Range: 0 – 4

Parameter	Configuration
0	RS-232 $\overline{\text{CTS}}$ flow control
1	RS-485 TX enable low
2	High
3	RS-485 TX enable high
4	Low

Default Parameter Value: 0

Number of bytes returned: 1

Related Commands: RT (GPI1 Configuration), TO (GPO1 Timeout)

CT (Command Mode Timeout) Command

<Command Mode Options> The CT command is used to set and read the amount of inactive time that elapses before the modem automatically exits from AT Command Mode and returns to Idle Mode.

Use the CN (Exit AT Command Mode) command to exit AT Command Mode manually.

AT Command: ATCT

Binary Command: 0x06 (6 decimal)

Parameter Range: 2 – 0xFFFF
[x 100 milliseconds]

Default Parameter Value: 0xC8 (200d)

Number of bytes returned: 2

Related Command: CN (Exit AT Command Mode)

DB (Received Signal Strength) Command

<Diagnostics> DB Command is used to read the receive signal strength (in decibels relative to milliwatts) of the last received packet. This parameter is useful in determining range characteristics of the RF modems under various conditions.

In default mode, this command shows the power level in signed decimal format with the units (dBm). If CF = 1, the magnitude of the value is presented in unsigned hex. If CF = 2, the value is presented in decimal, but without the units.

Sample Output: -88 dBm (when ATCF = 0)
58 (when ATCF = 1)
-88 (when ATCF = 2)

NOTE: If the DB register is read before the modem has received an RF packet, the modem will return a value of 0x8000 (which means an RF packet has not yet been received).

AT Command: ATDB

Binary Command: 0x36 (54 decimal)

Parameter Range (read-only): 0x6E – 0x28
(-110 to -40 Decimal)

Number of bytes returned: 2

DT (Destination Address) Command

<Networking & Security> DT Command is used to set/read the networking address of an RF modem. The modems utilize three filtration layers: Vendor ID Number (ATID), Channel (ATHP), and Destination Address (ATDT). The DT command assigns an address to a modem that enables it to communicate only with other modems having the same address. All modems that share the same DT parameter can communicate with each other.

RF modems in the same network with a different destination address (than that of the transmitter) will listen to all transmissions to stay synchronized, but will not send any of the data out their serial ports.

AT Command: ATDT

Binary Command: 0x00

Parameter Range: 0 – 0xFFFF

Default Parameter Value: 0

Number of bytes returned: 2

Related Commands: HP (Hopping Channel), ID (Modem VID), MK (Address Mask), MY (Source Address)

E0 (Echo Off) Command

<Command Mode Options> E0 Command turns off character echo in AT Command Mode.

By default, echo is off.

AT Command: ATE0

Binary Command: 0x0A (10 decimal)

E1 (Echo On) Command

<Command Mode Options> E1 Command enables character echo in AT Command Mode. Each typed character will be echoed back to the terminal when ATE1 is active. E0 (Echo Off) is the default.

AT Command: ATE1

Binary Command: 0x0B (11 decimal)

ER (Receive Error Count) Command

<Diagnostics> The ER command is used to set/read the number of receive-errors. The error count records the number of packets partially received then aborted on a reception error. This value returns to 0 after a reset and is not non-volatile (Value does not persist in the modem's memory after a power-up sequence). Once the Receive Error Count reaches its maximum value (up to 0xFFFF), it remains at its maximum count value until the maximum count value is explicitly changed or the modem is reset.

The ER parameter is not reset by pin, serial port or cyclic sleep modes.

AT Command: ATER

Binary Command: 0x0F (15 decimal)

Parameter Range: 0 – 0xFFFF

Default Parameter Value: 0

Number of bytes returned: 2

Related Commands: GD (Receive Good Count)

FH (Force Wake-up Initializer) Command

<Sleep (Low Power)> The FH command is used to force a Wake-up Initializer to be sent on the next transmission. Use only with cyclic sleep modes active on remote modems.

ATFH will not send a long header if ATHT = 0xFFFF. WR (Write) Command does not need to be issued with FH Command.

AT Command: ATFH

Binary Command: 0x0D (13 decimal)

FL (Software Flow Control) Command

<Serial Interfacing> The FL command is used to configure software flow control. Hardware flow control is implemented with the modem as the GP01 pin (CTS pin of the OEM RF module), which regulates when serial data can be transferred to the modem.

FL Command can be used to allow software flow control to also be enabled. The XON character used is 0x11 (17 decimal). The XOFF character used is 0x13 (19 decimal)

AT Command: ATFL

Binary Command: 0x07 (7 decimal)

Parameter Range: 0 – 1

Parameter	Configuration
0	Disable software flow control
1	Enable software flow control

Default Parameter Value: 0

Number of bytes returned: 1

FS (Forced Synch Time) Command

<RF Interfacing> The FS command only applies to streaming data. Normally, only the first packet of a continuous stream contains the full RF initializer. The RF modems then remain synchronized for subsequent packets of the stream. This parameter can be used to periodically force an RF initializer during such streaming. Any break in UART character reception long enough to drain the DI Buffer (UART receive buffer) and cause a pause in RF data transmission will also cause an RF initializer to be inserted on the next transmission.

AT Command: ATFS

Binary Command: 0x3E (62 decimal)

Parameter Range: 0 – 0xFFFF
[x 10 milliseconds]

Default Parameter Value: 0

Number of bytes returned: 2

FT (Flow Control Threshold) Command

<Serial Interfacing> The FT command is used to set/read the flow control threshold. When FT bytes have accumulated in the DI buffer (UART Receive), CTS is de-asserted or the XOFF software flow control character is transmitted.

AT Command: ATFT

Binary Command: 0x24 (36 decimal)

Parameter Range:
0 – (DI buffer size minus 0x11) [Bytes]

Default Parameter Value: DI Buffer size minus 0x11 (17 decimal)

Number of bytes returned: 2

GD (Receive Good Count) Command

<Diagnostics> The GD command is used to set/read the count of good received RF packets. Its parameter value is reset to 0 after every reset and is not non-volatile (The parameter value does not persist in the RF modem's memory after a power-up sequence). Once the "Receive Good Count" reaches its maximum value (up to 0xFFFF), it remains at its maximum count value until the maximum count value is manually changed or the modem is reset.

The GD parameter is not reset by pin, serial port or cyclic sleep modes.

AT Command: ATGD

Binary Command: 0x10 (16 decimal)

Parameter Range: 0 – 0xFFFF

Default Parameter Value: 0

Number of bytes returned: 2

Related Commands: ER (Receive Error Count)

HP (Hopping Channel) Command

<Networking & Security> The HP command is used to set/read the RF modem's hopping channel number. A channel is one of three layers of filtration available to the modem.

In order for modems to communicate with each other, the modems must have the same channel number since each channel uses a different hopping sequence. Different channels can be used to prevent modems in one network from listening to transmissions of another.

AT Command: ATHP

Binary Command: 0x11 (17 decimal)

Parameter Range: 0 – 9

Default Parameter Value: 0

Number of bytes returned: 1

Related Commands: ID (Modem VID), DT (Destination Address), MK (Address Mask)

HT (Time before Wake-up Initializer) Command

<Sleep (Low Power)> The HT command is used to set/read the time of inactivity (no serial or RF data is sent or received) before a wake-up initializer is sent by a TX (transmitting) RF modem. The HT parameter should be set shorter than inactivity timeout [ST Command] time of any RX (receiving) modems operating in Cyclic Sleep (SM=4-8). The wake-up initializer sent by the TX modem instructs all RX modems to remain awake to receive RF data.

From the RX modem perspective: After HT time elapses and the inactivity timeout [ST Command] is met, the RX modem goes into cyclic sleep. In cyclic sleep, the RX modem wakes once per sleep interval [SM Command] to check for a wake-up initializer. When a wake-up initializer is detected, the modem stays awake to receive data. The wake-up initializer must be longer than the cyclic sleep interval to ensure that sleeping modems detect incoming data.

When HT time elapses, the TX modem knows it needs to send a wake-up Initializer for all RX modems to remain awake and receive the next transmission.

AT Command: ATHT

Binary Command: 0x03 (3 decimal)

Parameter Range: 0 – 0xFFFF
[x 100 milliseconds]

Default Parameter Value: 0xFFFF (wake-up initializer will not be sent)

Number of bytes returned: 2

Related Commands: LH (Wake-up Initializer Timer), SM (Sleep Mode), ST (Time before Sleep)

HV (Hardware Version) Command

<Diagnostics> The HV command is used to read the hardware version of the RF modem.

AT Command: ATHV

Parameter Range: 0 – 0xFFFF [Read-only]

Minimum Firmware Version Required: v1.x80

ID (Modem VID) Command

<Networking & Security> The ID command is used to set/read the VID (Vendor Identification Number) of the RF modem. RF modems must have matching VIDs in order to communicate.

AT Command: ATID

Binary Command: 0x27 (39 decimal)

Parameter Range:

0x11 – 0x7FFF (user-settable)

0 – 0x10 & 0x8000 – 0xFFFF (factory-set)

Default Parameter Value: 0x3332 (13106d)

Number of bytes returned: 2

KY (AES Encryption Key) Command

<Networking & Security> The KY command is used to set the 256-bit AES (Advanced Encryption Standard) key for encrypting/decrypting data. Once set, the key cannot be read out of the modem by any means. The entire payload of the packet is encrypted using the key and the CRC is computed across the ciphertext. When encryption is enabled, each packet carries an additional 16 bytes to convey the random CBC Initialization Vector (IV) to the receiver(s). The KY value may be "0" or any 256-bit value (= 64 hex digits = 32 bytes). Any other value, including entering ATKY by itself with no parameters, causes an error.

A modem with the wrong key (or no key) will receive encrypted data, but the data driven out the serial port will be meaningless. Likewise, a modem with a key will receive unencrypted data sent from a modem without a key, but the output will be meaningless. Because CBC mode is utilized, repetitive data appears differently in different transmissions due to the randomly-generated IV.

AT Command: ATKY

Binary Command: 0x3C (60 decimal)

Parameter Range:

0 – (any other 64-digit hex valid key)

Default Parameter Value: 0 (disabled)

Number of bytes returned: 2

Number Base: Always Hexadecimal

LH (Wake-up Initializer Timer) Command

<Sleep (Low Power)> The LH Command is used to set/read the duration of time during which the wake-up initializer is sent. When receiving modems are in Cyclic Sleep Mode, they power-down after a period of inactivity (as specified by the ST parameter) and will periodically wake and listen for transmitted data. In order for the receiving modems to remain awake, they must detect ~35ms of the wake-up initializer.

LH Command must be used whenever a receiving modem is operating in Cyclic Sleep Mode. The Wake-up Initializer Time must be longer than the cyclic sleep time that [as determined by SM (Sleep Mode) parameter]. If the wake-up initializer time were less than the Cyclic Sleep interval, the connection would be at risk of missing the wake-up initializer transmission.

Refer to figures located under the SM command description to view diagrams of correct and incorrect configurations. The images emphasize that the LH value must be greater than the SM value.

AT Command: ATLH

Binary Command: 0x0C (12 decimal)

Parameter Range: 0 – 0xFF

[x 100 milliseconds]

Default Parameter Value: 1

Number of bytes returned: 1

Related Commands: HT (Time before Wake-up Initializer), SM (Sleep Mode), ST (Time before Sleep)

MD (RF Mode) Command

<Networking & Security> The MD command is used to select/read the settings that enable the Polling and Repeater Modes on the modem.

Polling Mode - A 'Polling Base' is responsible for polling remotes. A 'Polling Remote' requires a poll in order to transmit.

Repeater Mode - A 'Repeater' re-sends RF data unless the transmission is addressed to it or if the transmission has already been detected. A 'Repeater End Node' handles repeated messages, but will not repeat the message over-the-air.

Refer to the Polling and Repeater Mode sections of the 'RF Communication Modes' chapter for more information.

AT Command: ATMD

Binary Command: 0x31 (49 decimal)

Parameter Range: 0 – 6

Parameter	Configuration
0	Transparent Operation (Repeater Base)
1	[reserved – not used]
2	[reserved – not used]
3	Polling Base
4	Polling Remote
5	Repeater
6	Repeater End Node

Default Parameter Value: 0

Number of bytes returned: 1

Minimum Firmware Version Required: 2.x20

MK (Address Mask) Command

<Networking & Security> The MK command is used to set/read the Address Mask of a modem.

All RF data packets contain the Destination Address of the TX (transmitting) modem. When a packet is received, the TX modem Destination Address is logically "ANDed" (bitwise) with the Address Mask of the RX (receiving) modem. The resulting value must match the Destination Address or Address Mask of the RX modem for the packet to be received and sent out the RX modem's DO (Data Out) pin. If the "ANDed" value does not match the Destination Address or Address Mask of the RX modem, the packet is discarded.

Sniffer Mode (when MK = 0): ACK requests are ignored and every RX (receive) frame is sent to the UART, without regard for repeated frames.

All "0" values are treated as irrelevant values and ignored.

AT Command: ATMK

Binary Command: 0x12 (18 decimal)

Parameter Range: 0 – 0xFFFF

Default Parameter Value: 0xFFFF (65535d)

Number of bytes returned: 2

Related Commands: DT (Destination Address), HP (Hopping Channel), ID (Modem VID), MY (Source Address)

MT (Multi-transmit) Command

<Networking & Security> The MT command is used to enable multiple transmissions of RF data packets. When Multi-transmit Mode is enabled (MT > 0), packets do not request an ACK (acknowledgement) from the receiving RF modem(s). MT takes precedence over RR, so if both MT and RR are non-zero, then MT+1 packets will be sent (with no ACK requests).

When a receiving modem receives a packet with remaining forced retransmissions, it calculates the length of the packet and inhibits transmission for the amount of time required for all retransmissions. Thereafter, a random number of delay slots are inserted between 0 and RN before transmission is allowed from the receiving modem(s). This prevents all listening modems from transmitting at once upon conclusion of a multiple transmission event (when RN > 0).

NOTE: The actual number of forced transmissions is the parameter value plus one. For example, if MT = 1, two transmissions of each packet will be sent.

AT Command: ATMT

Binary Command: 0x3D (61 decimal)

Parameter Range: 0 – 0xFF

Default Parameter Value: 0 (no forced retransmissions)

Number of bytes returned: 1

Related Commands: Networking (DT, MK, MY, RN, TT), Serial Interfacing (BR, PK, RB, RO), RF Interfacing (FS)

MY (Source Address) Command

<Networking & Security> The MY command is used to set/read the Source Address of the RF modem.

AT Command: ATMY

Binary Command: 0x2A (42 decimal)

Parameter Range: 0 – 0xFFFF

Default Parameter Value: 0xFFFF (Disabled – DT (Destination Address) parameter serves as both source and destination address.)

Number of bytes returned: 2

Related Commands: DT (Destination Address), HP (Hopping Channel), ID (Modem VID), MK (Address Mask)

NB (Parity) Command

<Serial Interfacing> The NB command is used to select/read the parity settings of the RF modem for UART communications.

AT Command: ATNB

Binary Command: 0x23 (35 decimal)

Parameter Range: 0 – 4

Parameter	Configuration
0	8-bit (no parity or 7-bit (any parity))
1	8-bit even
2	8-bit odd
3	8-bit mark
4	8-bit space

Default Parameter Value: 0

Number of bytes returned: 1

PB (Polling Begin Address) Command

<Networking & Security> PB command is used to set/read the modem's Polling Begin Address - the first address polled Polling Mode is enabled.

Polling Operations: The 'Polling Base' (MD = 3) cycles through a sequential range of addresses, polling each 'Polling Remote' (MD = 4). The base then waits for a response & proceeds to the next 'Polling Remote'. Each 'Polling Remote' responds by sending the data from the Data In buffer following the RB & RO parameters. When there is no eligible data to send, the 'Polling Remote' will not respond. The 'Polling Base' will move to the next address in the polling sequence after a short delay.

AT Command: ATPB

Binary Command: 0x45 (69 decimal)

Parameter Range: 0 – 0xFFFF

Default Parameter Value: 0

Number of bytes returned: 2

Minimum Firmware Version Required: 2.x20

Related Commands: MD (RF Mode), PE (Polling End Address), PD (Minimum Polling Delay)

PD (Minimum Polling Delay) Command

<Networking & Security> The PD command is used to set/read Polling Delay (Base, MD=3) or Polling Timeout (Remote, MD=4).

Polling Delay (Base) is the time between polling cycles. The Polling Base will start the polling cycle after sending the first poll. After the polling cycle has completed, the timer is restarted.

Polling Timeout (Remote) is the amount of time the remote unit will hold data from the serial port before discarding it. Data entered within the PD time of the poll is transmitted and not discarded.

AT Command: ATPD

Binary Command: 0x47 (71 decimal)

Parameter Range: 0 – 0xFFFF
(Base: [x 1ms], Remote: [x 10ms])

Default Parameter Value: 0

Number of bytes returned: 2

Minimum Firmware Version Required: 2.x20

Related Commands: MD (RF Mode), PB (Polling Begin Address), PE (Polling End Address)

PE (Polling End Address) Command

<Networking & Security> PE command is used to set/read the modem's Polling End Address - the last address polled when Polling Mode is enabled.

Polling Operations: The 'Polling Base' (MD = 3) cycles through a sequential range of addresses, polling each 'Polling Remote' (MD = 4). The base then waits for a response & proceeds to the next 'Polling Remote'. Each 'Polling Remote' responds by sending data from the DI buffer following the RB & RO parameters. When there is no eligible data to send, the 'Polling Remote' will not respond. The 'Polling Base' will move to the next address in the polling sequence after a short delay.

AT Command: ATPE

Binary Command: 0x46 (70 decimal)

Parameter Range: 0 – 0xFFFF

Default Parameter Value: 0

Number of bytes returned: 2

Minimum Firmware Version Required: 2.x20

Related Commands: MD (RF Mode), PB (Polling Begin Address), PD (Minimum Polling Delay)

PK (Maximum RF Packet Size) Command

<RF Interfacing> The PK command is used to set/read the maximum size of RF packets transmitted from an RF modem. The maximum packet size can be used along with the RB and RO parameters to implicitly set the channel dwell time.

If PK is set above 256 and BR is subsequently changed to 0, PK will automatically be lowered to 256 and a warning will be raised (refer to the BR (RF Data Rate) and WN (Warning Data) commands for details).

Changes to the PK parameter may have a secondary effect on the RB (Packetization Threshold) parameter. RB must always be less than or equal to PK. If PK is changed to a value that is less than the current value of RB, the RB value is automatically lowered to be equal to PK.

* When BR = 0 (9600 baud), the maximum PK value is 0x100 (256d). When BR = 1 (115,200 baud), the maximum PK value is 0x800 (2048d).

AT Command: ATPK

Binary Command: 0x29 (41 decimal)

Parameter Range: 1 – 0x800 [Bytes]

Default Parameter Value: 0x100* or 0x800* (256 or 2048 decimal)

Number of bytes returned: 2

Related Commands: BR (RF Data Rate) RB (Packetization Threshold), RO (Packetization Timeout), WN (Warning Data)

PL (TX Power Level) Command

<RF Interfacing> The PL command is used to set/read the power level at which the RF modem transmits data.

AT Command: ATPL

Binary Command: 0x3A (58 decimal)

Parameter Range: 0 – 4

Parameter	Configuration
0	1 mW
1	10 mW
2	100 mW
3	500 mW
4	1000 mW (1 Watt)

Default Parameter Value: 4

Number of bytes returned: 1

PW (Pin Wake-up) Command

<Sleep (Low Power)> Under normal operation, an RF modem in Cyclic Sleep Mode cycles from an active state to a low-power state at regular intervals until data is ready to be received. If the PW parameter is set to 1, the SLEEP pin (GPI2) can be used to awaken the modem from Cyclic Sleep. When the SLEEP Pin is de-asserted (low), the modem will be fully operational and will not go into Cyclic Sleep.

Once the SLEEP pin is asserted, the modem will remain active for the period of time specified by the ST (Time before Sleep) parameter and will return to Cyclic Sleep Mode (if no data is ready to be transmitted). PW Command is only valid if Cyclic Sleep has been enabled.

AT Command: ATPW

Binary Command: 0x1D (29 decimal)

Parameter Range: 0 – 1

Parameter	Configuration
0	Disabled
1	Enabled

Default Parameter Value: 0

Number of bytes returned: 1

Related Commands: SM (Sleep Mode), ST (Time before Sleep)

RB (Packetization Threshold) Command

<Serial Interfacing> The RB command is used to set/read the character threshold value.

RF transmission begins after data is received in the DI Buffer and either of the following criteria is met:

- RB characters received by the UART
- RO character times of silence detected on the UART receive lines (after receiving at least 1 Byte of data)

If PK (Max. RF Packet Size) is lowered below the value of RB, RB is automatically lowered to match the PK value. If (RO = 0), RB bytes must be received before beginning transmission.

Note: RB and RO criteria only apply to the first packet of a multi-packet transmission. If data remains in the DI Buffer after the first packet, transmissions will continue in a streaming manner until there is no data left in the DI Buffer (UART receive buffer).

AT Command: ATRB

Binary Command: 0x20 (32 decimal)

Parameter Range: 0 – PK parameter value (up to 0x800 Bytes)

Default Parameter Value: 0x800 Bytes

Number of bytes returned: 2

Related Commands: BR (RF Data Rate), PK (RF Packet Size), RO (Packetization Timeout)

RC (Ambient Power - Single Channel) Command

<Diagnostics> The RC command is used to examine and report the power level on a given channel.

Sample output: -78 dBm [when CF = 0]
4e [when CF = 1]
-78 [when CF = 2]

AT Command: ATRC

Parameter Range (read-only): 0 – 0x31 [dBm]

Number of bytes returned: 1

Related Commands: RM (Ambient Power – All Channels)

RE (Restore Defaults) Command

<Diagnostics> The RE command is used to restore all configurable parameters to their factory default settings.

The RE Command does not cause default values to be stored to non-volatile (persistent) memory. For the restored default settings to persist in the modem's non-volatile memory and be saved in the event of RF modem reset or power-down, the WR (Write) command must be issued prior to power-down or reset.

AT Command: ATRE

Binary Command: 0x0E (14 decimal)

RM (Ambient Power - All Channels) Command

<Diagnostics> The RM command is used to examine and report power levels on all channels. If no parameter is given, the channels are scanned one time. If a parameter is given, the channels are repeatedly scanned for that number of seconds. The maximum power level seen for each channel is reported (i.e. peak hold).

A graphical spectrum analyzer can be implemented by repeatedly sending the RM command (with no arguments) and reading the resultant 50 power levels (this is easiest to do when CF = 1 or 2).

Sample output [when CF = 0]: Ch 0: -100 dBm
Ch 1: -103 dBm
...
Ch 49: -99 dBm

Sample output [when CF = 1]: 64
67
...
63

Sample output [when CF = 2]: 100
-103
...
-99

AT Command: ATRM

Parameter Range: no parameter – 0x7D0)

Number of bytes returned: 2

Related Commands: RC (Ambient Power – Single channel)

RN (Delay Slots) Command

<Networking & Security> The RN command is used to set/read the time delay that the transmitting RF modem inserts before attempting to resend a packet. If the transmitting modem fails to receive an acknowledgement after sending a packet, it inserts a random number of delay slots (ranging from 0 to (RN minus 1)) before attempting to resend the packet. Each delay slot is 5 msec (when BR=1) and 54 msec (when BR=0).

If two modems attempt to transmit at the same time, the random time delay after packet failure allows only one modem to transmit the packet successfully; while the other modem waits until the channel available for RF transmission.

RN Command is only applicable if retries have been enabled [RR (Retries) Command] or if forced delays will be inserted into a transmission [TT (Streaming Limit) Command].

AT Command: ATRN

Binary Command: 0x19 (25 decimal)

Parameter Range: 0 – 0xFF [38 ms slots]

Default Parameter Value: 0
(no delay slots inserted)

Number of bytes returned: 1

Related Commands: RR (Retries), TT (Streaming Limit)

RO (Packetization Timeout) Command

<Serial Interfacing> The RO command is used to set/read the Packetization Timeout setting. RF transmission begins when data is in the DI buffer and either of the following criteria are met:

- RO character times of silence on the UART receive lines (after receiving at least 1 byte)
- RB characters have been received by the UART

RB and RO criteria only apply to the first packet of a multi-packet transmission. If data remains in the DI Buffer (UART receive) after the first packet, transmissions will continue in a streaming manner until there is no data left in the DI Buffer.

When RO is the transmission-beginning criteria: The actual time between the reception of the last character from the UART and the beginning of RF transmission will be at least 800 µsec longer than the actual RO time to allow for transmission setup. Additionally, it is subject to 100-200 µsec of additional uncertainty, which could be significant for small values of RO at high UART bit rates.

The correct UART character time (10, 11, or 12 bits) is calculated based on the following criteria:

- 1 start bit
- 8 data bits
- 0 or 1 parity bit [as determined by the NB (Parity) Command]
- 1 or 2 stop bits [as determined by SB (Stop Bits) Command]

AT Command: ATRO

Binary Command: 0x21 (33 decimal)

Parameter Range: 0 – 0xFFFF
[x UART character times]

Default Parameter Value: 3

Number of bytes returned: 2

Related Commands: RB (Packetization Threshold)

RP (RSSI PWM Timer) Command

<Diagnostics> RP Command is used to enable a PWM ("Pulse Width Modulation") output on the Config/RSSI pin (pin 11 of the OEM RF Module). The pin is calibrated to show the difference between received signal strength and the sensitivity level of the RF modem. PWM pulses vary from zero to 95 percent. Zero percent means the received RF signal is at or below the published sensitivity level of the modem.

The following table shows dB levels above sensitivity and PWM values (The total time period of the PWM output is 8.32 ms. PWM output consists of 40 steps and therefore the minimum step size is 0.208 ms.):

Table 4-02. PWM Values

dBm above sensitivity	PWM percentage (high period / total period)
10	20%
20	35%
30	50%

A non-zero value defines the time that PWM output is active with the RSSI value of the last received RF packet. After the set time when no RF packets are received, PWM output is set low (0 percent PWM) until another RF packet is received. PWM output is also set low at power-up. A parameter value of 0xFF permanently enables PWM output and always reflects the value of the last received RF packet.

The Config/RSSI pin is shared between PWM output and Config input. When the modem is powered, the Config pin is an input. During the power-up sequence, if RP parameter is a non-zero value, the Config pin is configured as an output and set low until the first RF packet is received. With a non-zero RP parameter, the Config pin is an input for RP ms after power up.

RR (Retries) Command

<Networking & Security> The RR command is used to set/read the maximum number of retries sent for a given RF packet. When RR Command is enabled (RR>0), RF packet retries and ACKs (acknowledgements) are enabled.

Exceptions: If the MT command is enabled (MT>0) or if a broadcast Destination Address is used (DT = 0xFFFF); RF packet retries and ACKs are disabled.

After transmitting a packet, the transmitting RF modem waits to receive an acknowledgement from a receiving modem. If the acknowledgement is not received in the period of time specified by RN (Delay Slots) Command, the original packet is transmitted again. The RF packet is transmitted repeatedly until an acknowledgement is received or until the packet is sent RR times.

AT Command: ATRP

Binary Command: 0x22 (34 decimal)

Parameter Range: 0 – 0xFF
[x 100 milliseconds]

Default Parameter Value: 0x20 (32d)

Number of bytes returned: 1

AT Command: ATRR

Binary Command: 0x18 (24 decimal)

Parameter Range: 0 – 0xFF

Default Parameter Value: 0x0A (10 decimal)

Number of bytes returned: 1

RT (GPI 1 Configuration) Command

<Serial Interfacing> The RT command is used to set/read the behavior of the GPI1 pin (pin 10) of the OEM RF Module. The pin can be configured to enable binary programming or $\overline{\text{RTS}}$ flow control.

AT Command: ATRT

Binary Command: 0x16 (22 decimal)

Parameter Range: 0 – 2

Parameter	Configuration
0	Disabled
1	Enable Binary Programming
2	Enable $\overline{\text{RTS}}$ Flow Control

Default Parameter Value: 0

Number of bytes returned: 1

SB (Stop Bits) Command

<Serial Interfacing> The SB Command is used to set/read the number of stop bits in the data packet.

AT Command: ATSB

Binary Command: 0x37 (55 decimal)

Parameter Range: 0 – 1

Parameter	Configuration
0	1 stop bit
1	2 stop bits

Default Parameter Value: 0

Number of bytes returned: 1

SH (Serial Number High) Command

<Diagnostics> SH Command is used to set/read the serial number high word of the RF modem.

AT Command: ATSH

Binary Command: 0x25 (37 decimal)

Parameter Range (read-only): 0 – 0xFFFF

Default Parameter Value: varies

Number of bytes returned: 2

Related Commands: SL (Serial Number Low)

SL (Serial Number Low) Command

<Diagnostics> SL Command is used to set/read the serial number low word of the RF modem.

AT Command: ATSL

Binary Command: 0x26 (38 decimal)

Parameter Range (read-only): 0 – 0xFFFF

Default Parameter Value: varies

Number of bytes returned: 2

Related Commands: SH (Serial Number High)

SM (Sleep Mode) Command

<Sleep Mode (Low Power)> The SM Command is used to set/read the RF modem's Sleep Mode settings that configure the modem to run in states that require minimal power consumption.

AT Command: ATSM

Binary Command: 0x01

Parameter Range: 0 – 8 (3 is reserved)

Parameter	Configuration
0	Disabled
1	Pin Sleep
2	Serial Port Sleep
3	[reserved]
4	Cyclic 1.0 second sleep (RF modem wakes every 1.0 seconds)
5	Cyclic 2.0 second sleep
6	Cyclic 4.0 second sleep
7	Cyclic 8.0 second sleep
8	Cyclic 16.0 second sleep

Default Parameter Value: 0

Number of bytes returned: 1

Related Commands:

Pin Sleep – PC (Power-up Mode), PW (Pin Wake-up)

Serial Port Sleep – ST (Time before Sleep)

Cyclic Sleep – ST (Time before Sleep), LH (Wake-up Initializer Timer), HT (Time Before Wake-up Initializer), PW (Pin Wake-up)

ST (Time before Sleep) Command

<Sleep Mode (Low Power)> The ST Command is used to set/read the period of time (in milliseconds) in which the RF modem remains inactive before entering Sleep Mode.

For example, if the ST Parameter is set to 0x64 (100 decimal), the modem will enter into Sleep mode after 10 seconds of inactivity (no transmitting or receiving).

This command can only be used if Cyclic Sleep or Serial Port Sleep Mode settings have been selected using SM (Sleep Mode) Command.

AT Command: ATST

Binary Command: 0x02 (2 decimal)

Parameter Range: (ATAT+3) – 0x7FFF
[x 100 milliseconds]

Default Parameter Value: 0x64 (100 decimal)

Number of bytes returned: 2

Related Commands: SM (Sleep Mode), LH (Wake-up Initializer Timer), HT (Time before Wake-up Initializer)

TP (Board Temperature) Command

<Diagnostics> TP Command is used to read the current temperature of the board.

Sample Output: 26 C [when ATCF = 0]
1A [when ATCF = 1]
26 [when ATCF = 2].

AT Command: ATTP

Binary Command: 0x38 (56 decimal)

Parameter Range (read-only): 0– 0x7F

Number of bytes returned: 1

Related Command: WN (Warning Data)

TR (Transmit Error Count) Command

<Diagnostics> The TR command is used to report the number of retransmit failures. This number is incremented each time a packet is not acknowledged within the number of retransmits specified by the RR (Retries) parameter. The number of packets therefore are counted that were not successfully received and subsequently discarded.

The TR parameter is not non-volatile and is reset to zero when the RF modem is reset.

AT Command: ATTR

Binary Command: 0x1B (27 decimal)

Parameter Range: 0 – 0xFFFF

Default Parameter Value: 0

Number of bytes returned: 2

Related Commands: RR (Retries)

TT (Streaming Limit) Command

<Networking & Security> The TT command is used to set/read the limit on the number of bytes that can be sent out before a random delay is issued.

If an RF modem is sending a continuous stream of RF data, a delay is inserted which stops its transmission and allows other modems time to transmit (once it sends TT bytes of data). Inserted random delay lasts between 1 & 'RN + 1' delay slots, where each delay slot lasts 38 ms.

The TT command can be used to simulate full-duplex behavior.

AT Command: ATTT

Binary Command: 0x1A (26 decimal)

Parameter Range: 0 – 0xFFFF

Default Parameter Value: 0 (disabled)

Number of bytes returned: 2

Related Commands: RN (Delay Slots)

TX (Transmit Only) Command

<RF Interfacing> The TX command is used to set/read the transmit/receive behaviors of the RF modem. Setting a modem to TX-only (TX = 1) may reduce latency because the transmitting modem will never be confined to receiving data from other modems.

AT Command: ATTX

Binary Command: 0x3F (63 decimal)

Parameter Range: 0 – 1

Parameter	Configuration
0	TX & RX
1	TX-only

Default Parameter Value: 0

Number of bytes returned: 1

VL (Firmware Version - Verbose)

<Diagnostics> The VL command is used to read the verbose firmware version of the RF modem.

AT Command: ATVL

Parameter Range: returns string

Default Parameter Value: 0

Number of bytes returned: 2

VR (Firmware Version - Short) Command

<Diagnostics> The VR command is used to read the firmware version of the RF modem.

Note: Firmware versions contain four significant digits - "A.B.C.D". If B=2, the modem is programmed for operation in Australia only.

AT Command: ATVR

Binary Command: 0x14 (20 decimal)

Parameter Range (read-only): 0 – 0xFFFF

Number of bytes returned: 2

WA (Active Warning Numbers) Command

<Diagnostics> The WA command reports the warning numbers of all active warnings - one warning number per line. No further information is shown and warning counts are not reset.

AT Command: ATWA

Parameter Range: Returns string – one warning number per line.

Sample Output (indicates warnings 1 and 3 are currently active):

```

1
3
OK

```

WN (Warning Data) Command

<Diagnostics> WN command is used to report the following data for all active and sticky warnings:

AT Command: ATWN

Parameter Range: returns string

- Warning number & description
- Number of occurrences since the last WN or WS command
- Whether the warning is currently active

Warnings, which are not currently active and have not been active since the last issuance of the WN or WS commands, are not displayed. The WN command also resets all non-zero warning counts; except for warnings that are presently active, which are set to 1.

Sample output: Warning 4: Over-temperature
5 occurrences; presently inactive.

Warning #	Description
1	Under-voltage. This is caused if the supply voltage falls below the minimum threshold for the lowest power level (2.8 V). If/when the voltage rises above the threshold, the warning is deactivated. The module will not transmit below this voltage threshold.
2	Over-voltage. This is caused if the supply voltage exceeds 5.75 V. Transmission is not allowed while this warning is active.
3	Under-temperature. This is caused if the temperature sensed by the module is less than -40 C. The module does not artificially limit operation while this warning is active, but module functionality is not guaranteed.
4	Over-temperature. This is caused if the temperature sensed by the module is greater than 105 C. The module does not allow transmission nor reception while this warning is active. The warning is deactivated when the temperature falls to 100 C.
5	Power reduced. This is caused if the transmit power has to be reduced from the level programmed by PL Command due to insufficient supply voltage. The 1 W power level requires 4.75 V or higher; 500 mW requires 3.0 V or higher; 100 mW, 10 mW and 1 mW require 2.8 V or higher.
6	Default calibration data in flash. This is caused if the module-specific power calibration data is either not present or is invalid, or if none of the parameters have been modified from their default values. Power levels may be incorrect.
7	Default configuration parameters in flash. This is caused if user-modifiable parameters (i.e. those stored by a 'WR' command) in flash are all the compiled-in default values. This is caused if the user configuration is found to be not present or invalid at power-up and there is no custom configuration, or if no user-modifiable parameters have been modified from the compiled-in defaults. Modification of one or more parameters without the subsequent WR to commit the changes to flash will not deactivate this warning, since it reflects the status of the parameters in flash. Note that this warning does not reflect usage of the custom configuration defaults, only usage of the compiled-in defaults.
8	Default factory configuration parameters in flash. This is caused if the factory parameters in flash are all the default values. This is caused if the factory configuration is found to be not present or invalid at power-up, or if no factory parameters have been modified.

WR (Write) Command

<(Special)> The WR command is used to write configurable parameters to non-volatile memory (Values remain in the modem's memory until overwritten by another use of WR Command).

AT Command: ATWR

Binary Command: 0x08

If changes are made without writing them to non-volatile memory, the modem will revert back to previously saved parameters the next time the modem is powered-on.

If the non-volatile user configuration is not correct, WR will re-attempt (up to 3x). If all three attempts fail, the command will return an ERROR alert.

WS (Sticky Warning Numbers) Command

<Diagnostics> The WS command reports warning numbers of all warnings active since the last use of the WS or WN command (including any warnings which are currently active). This command also resets all non-zero warning counts, except for warnings that are presently active, which are set to 1.

AT Command: ATWS

Parameter Range (read-only): 1 – 8

Number of bytes returned: 1

4.4. API Operation

By default, XTend RF Modems act as a serial line replacement (Transparent Operation) - all UART data received through the DI pin is queued up for RF transmission. When the modem receives an RF packet, the data is sent out the DO pin with no additional information.

Inherent to Transparent Operation are the following behaviors:

- If modem parameter registers are to be set or queried, a special operation is required for transitioning the modem into Command Mode [refer to p18].
- In point-to-multipoint systems, the application must send extra information so that the receiving modem(s) can distinguish between data coming from different remotes.

As an alternative to the default Transparent Operation, API (Application Programming Interface) Operations are available. API operation requires that communication with the modem be done through a structured interface (data is communicated in frames in a defined order). The API specifies how commands, command responses and modem status messages are sent and received from the modem using a UART Data Frame.

4.4.1. API Frame Specifications

Two API modes are supported and both can be enabled using the AP (API Enable) command. Use the following AP parameter values to configure the modem to operate in a particular mode:

- AP = 0 (default): Transparent Operation (UART Serial line replacement)
API modes are disabled.
- AP = 1: API Operation
- AP = 2: API Operation (with escaped characters)

Any data received prior to the start delimiter is silently discarded. If the frame is not received correctly or if the checksum fails, the data is silently discarded.

API Operation (AP parameter = 1)

When this API mode is enabled (AP = 1), the UART data frame structure is defined as follows:

Figure 4-03. UART Data Frame Structure:



MSB = Most Significant Byte, LSB = Least Significant Byte

API Operation - with Escape Characters (AP parameter = 2)

When this API mode is enabled (AP = 2), the UART data frame structure is defined as follows:

Figure 4-04. UART Data Frame Structure - with escape control characters:

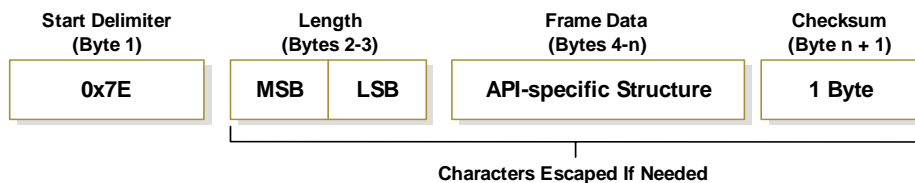

MSB = Most Significant Byte, LSB = Least Significant Byte

Escape characters. When sending or receiving a UART data frame, specific data values must be escaped (flagged) so they do not interfere with the UART or UART data frame operation. To escape an interfering data byte, insert 0x7D and follow it with the byte to be escaped XOR'd with 0x20.

Data bytes that need to be escaped:

- 0x7E – Frame Delimiter
- 0x7D – Escape
- 0x11 – XON
- 0x13 – XOFF

Example - Raw UART Data Frame (before escaping interfering bytes):
 0x7E 0x00 0x02 0x23 0x11 0xCB
 0x11 needs to be escaped which results in the following frame:
 0x7E 0x00 0x02 0x23 0x7D 0x31 0xCB

Note: In the above example, the length of the raw data (excluding the checksum) is 0x0002 and the checksum of the non-escaped data (excluding frame delimiter and length) is calculated as:
 $0xFF - (0x23 + 0x11) = (0xFF - 0x34) = 0xCB$.

Checksum

To test data integrity, a checksum is calculated and verified on non-escaped data.

To calculate: Not including frame delimiters and length, add all bytes keeping only the lowest 8 bits of the result and subtract from 0xFF.

To verify: Add all bytes (include checksum, but not the delimiter and length). If the checksum is correct, the sum will equal 0xFF.

4.4.2. API Types

Frame data of the UART data frame forms an API-specific structure as follows:

Figure 4-05. UART Data Frame & API-specific Structure:

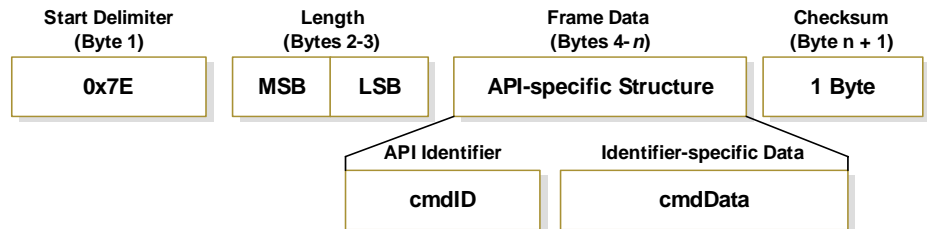

The cmdID frame (API-identifier) indicates which API messages will be contained in the cmdData frame (Identifier-specific data). Refer to the sections that follow for more information regarding the supported API types. Note that multi-byte values are sent big endian.

RF Modem Status

API Identifier: 0x8A

RF modem status messages are sent from the modem in response to specific conditions.

Figure 4-06. RF Modem Status Frames

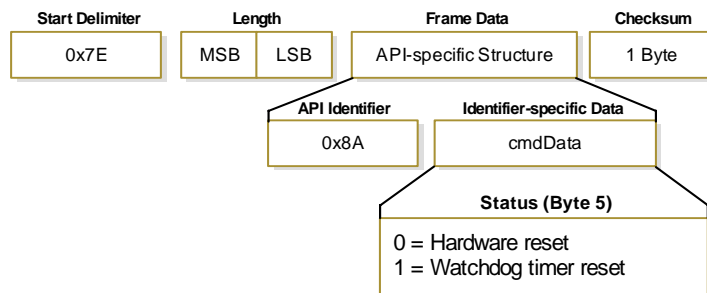

TX (Transmit) Request: 16-bit address

API Identifier Value: 0x01

A TX Request message will cause the modem to send RF Data as an RF Packet.

Figure 4-7. TX Packet (16-bit address) Frames

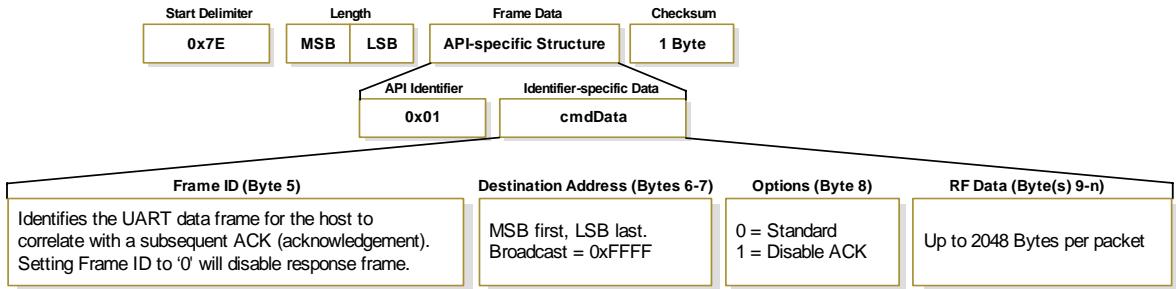

Figure 4-8. Example: TX Packet API Frames



* Length [Bytes] = API Identifier + Frame ID + Destination Address + Option + RF Data

** "R" value was arbitrarily selected

TX (Transmit) Status

API Identifier Value: 0x89

When a TX Request is completed, the modem sends a TX Status message. This message will indicate if the packet was transmitted successfully or if there was a failure.

Figure 4-9. TX Status Frames

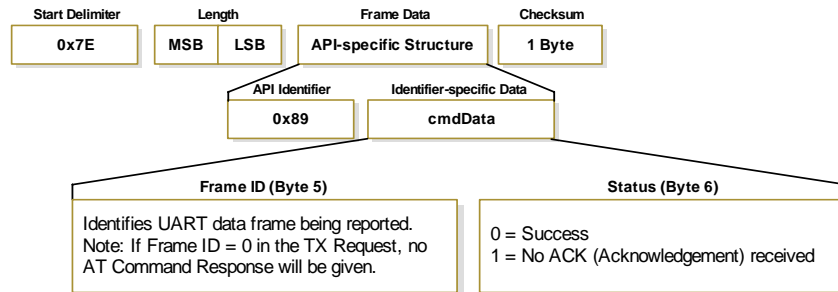

NOTE: "STATUS = 1" occurs when all retries are expired and no ACK is received.

"STATUS = 3" occurs when a packet is purged due to a 'Polled Remote' not receiving a poll.

RX (Receive) Packet: 16-bit address

API Identifier Value: 0x81

When the modem receives an RF packet, it is sent out the UART using this message type.

Figure 4-10. RX Packet (16-bit address) Frames

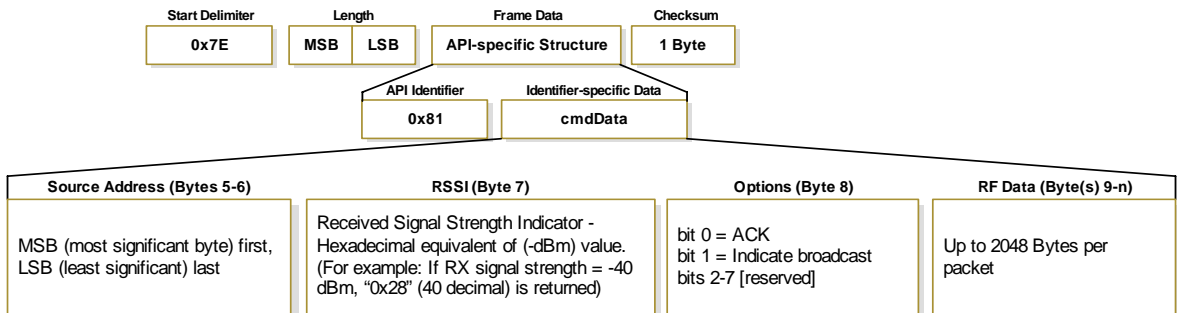



5. RF Communication Modes

The network configurations covered in this chapter are described in terms of the following:

- Network Topology (Point-to-Point, Point-to-Multipoint or Peer-to-Peer)
- RF Communication Type (Basic or Acknowledged)
- RF Mode (Streaming, Multi-Transmit, Repeater, Acknowledged or Polling)

The following table provides a summary of the network configurations supported by the XTend RF Modem.

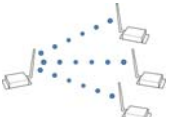
Table 5-01. Summary of network topologies supported by the XTend Ethernet RF Modem

Point-to-Point			
	Definition	An RF data link between two modems.	
	Sample Network Profile * (Broadcast Communications)	Use default values for all modems.	
	Sample Network Profile * (Acknowledged Communications)	All modems: ATAM [auto-set MY (Source Address) parameter] ** ATDT FFFF [set Destination Address to 0xFFFF]	
	Basic RF Modes	Streaming, Multi-Transmit, Repeater	
	Acknowledged RF Mode	Acknowledged Mode	
Point-to-Multipoint			
	Definition	RF data links between one base and multiple remotes.	
	Sample Network Profile * (Basic Communications)	Base:	ATMY 0 [set Source Address to 0x00] ATDT FFFF [set Destination Address to 0xFFFF]
		Remotes:	ATAM [auto-set MY (Source Address) parameter] ** ATDT 0 [set Destination Address to 0x00]
	Sample Network Profile * (Acknowledged Communications)	Base:	ATMY 0 [set Source Address to 0x00] ATDT FFFF [set Destination Address to 0xFFFF] ATRR 3 [set number of Retries to 3]
		Remotes:	ATAM [auto-set MY (Source Address) parameter] ** ATDT 0 [set Destination Address to 0x00] ATRR 3 [set number of Retries to 3]
	Basic RF Modes	Streaming, Multi-Transmit, Repeater, Polling	
Acknowledged RF Modes	Acknowledged, Polling		
Peer-to-Peer			
	Definition	RF modems remain synchronized without use of master/server dependencies. Each modem shares the roles of master and slave. MaxStream's peer-to-peer architecture features fast synch times (35ms to synchronize modems) and fast cold start times (50ms before transmission).	
	Sample Network Profile * (Basic Communications)	Use default values for all modems.	
	Sample Network Profile * (Acknowledged Communications)	All modems: ATAM [auto-set MY (Source Address) parameter] ** ATDT FFFF [set Destination Address to 0xFFFF] ATRR 3 [set number of Retries to 3]	
	Basic RF Mode	Streaming	
	Acknowledged RF Mode	Acknowledged	

* Assume default values for parameters not listed. Profiles do not reflect addressing implementations.

** AM (Auto-set MY) Command must be issued through a terminal program such as the one incorporated in the X-CTU 'Terminal' tab.

5.1. Addressing

Each RF packet contains addressing information that is used to filter incoming RF data. Receiving modules inspect the Hopping Channel (HP parameter), Vendor Identification Number (ID parameter) and Destination Address (DT parameter) contained in each RF packet. Data that does not pass through all three network security layers is discarded.

Figure 5-01. Addressing layers contained in the RF packet header

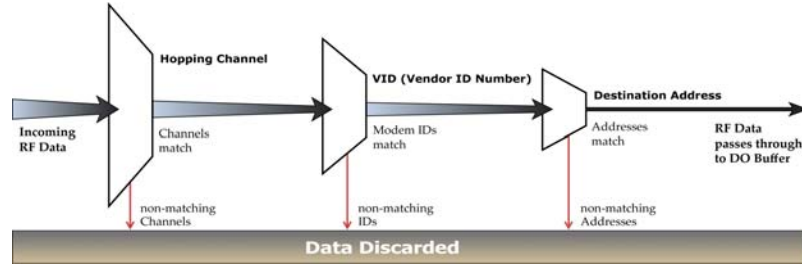

5.1.1. Address Recognition

Transmissions can be addressed to a specific modem or group of modems using the DT (Destination Address) and MK (Address Mask) commands. A receiving modem will only accept a packet if it determines the packet is addressed to it, either as a global or local packet. The receiving modem makes this determination by inspecting the destination address of the packet and comparing it to its own address and address mask [refer to the figure below].

Figure 5-02. Address Recognition (@ the Receiving RF Modem)

TX_DT = Destination Address of transmitting modem
 RX_DT = Destination Address of receiving modem
 RX_MK = Address Mask of receiving modem
 RX_MY = Source Address of receiving modem

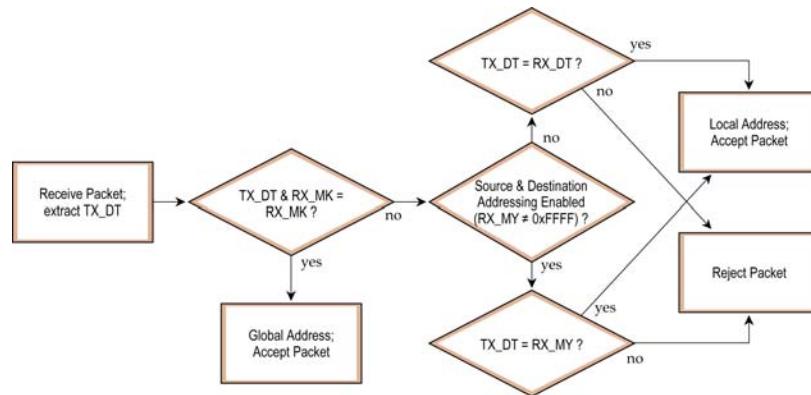

The transmitting modem determines whether the packet is intended for a specific node (local address) or multiple nodes (global address) by comparing the packet's destination address (DT) and its own address mask (MK) [refer to the figure below]. It is assumed that the address masks on the transmitting modem and receiving modem have been programmed to the same value for proper operation in each RF Communication Mode.

Figure 5-03. Address Recognition (@ the Transmitting RF Modem)

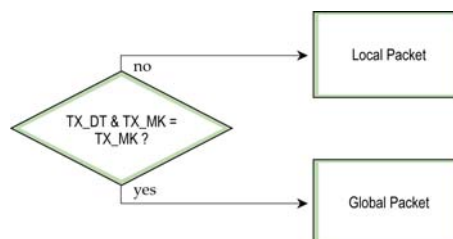

5.2. Basic Communications

Basic Communications are accomplished through two sub-types:

- Broadcast - By default, XTend RF Modems communicate through Broadcast communications and within a peer-to-peer network topology. When any modem transmits, all other modems within range will receive the data and pass it directly to their host device.
- Addressed - If addressing parameters match are in order, received RF data is forwarded to the DO (Data Out) buffer; otherwise, the RF data is discarded.

When using Basic Communications, any functions such as acknowledgements are handled at the application layer by the OEM/integrator. The Broadcast Modes provide transparent communications, meaning that the RF link simply replaces a wired link.

5.2.1. Streaming Mode (Default)

Characteristics: Highest data throughput

Lowest latency and jitter

Reduced immunity to interference

Transmissions never acknowledged (ACK) by receiving module(s)

Required Parameter Values (TX modem): RR (Retries) = 0

Related Commands: Networking (DT, MK, MY), Serial Interfacing (PK, RB, RO, TT)

Recommended Use: Mode is most appropriate for data systems more sensitive to latency and/or jitter than to occasional packet loss. For example: streaming audio or video.

Connection Sequence

Figure 5-04. Streaming Mode State Diagram (TX Module)

- Events & processes in this mode are common to all of the other RF Modes.
- When streaming data, RB and RO parameters are only observed on the first packet.

After transmission begins, the transmission event will continue uninterrupted until the DI buffer is empty or the streaming limit (TT parameter) is reached. As with the first packet, the payload of each subsequent packet includes up to the maximum packet size (PK parameter).

The TT parameter (streaming limit) is specified by the TX (transmitting) modem as the maximum number of bytes the TX module can send in one transmission event. After the TT parameter threshold is reached, the TX modem will force a random delay of 1 to RN delay slots (exactly 1 delay slot if RN = 0).

Subsequent packets are sent without an RF initializer since RX (receiving) modems remain synchronized with the TX modem for the duration of the transmission (from preceding packet information). However, due to interference, some RX modems may lose data (and synchronization to the TX modem), particularly during long transmission events.

Once the TX modem has sent all pending data or has reached the TT limit, the transmission event ends. The TX modem will not transmit again for exactly RN delay slots if the local (i.e. TX modem's) RN parameter is set to a non-zero value. The RX modem(s) will not transmit for a random number of delay slots between 0 and (RN-1) if the local (i.e. receiving module's) RN parameter is set to a non-zero value. These delays are intended to lessen congestion following long bursts of packets from a single TX modem, during which several RX modems may have become ready to transmit.

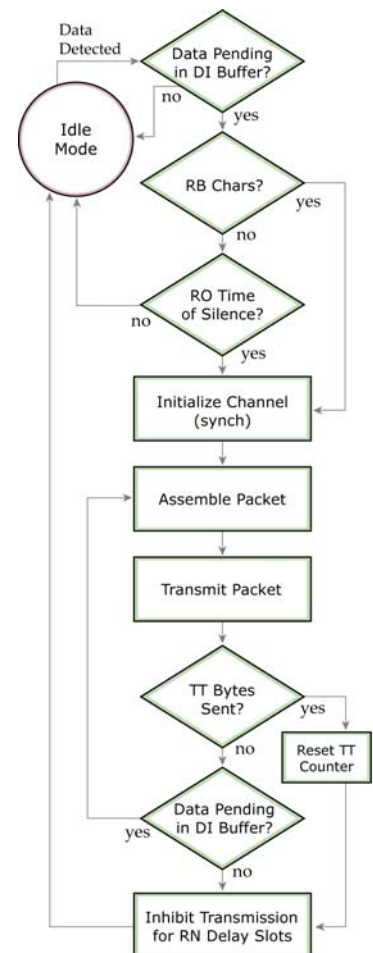

5.2.2. Multi-Transmit Mode

Attributes: Reliable Delivery through forced transmission of every RF packet
 Every RF packet is sent exactly (MT + 1) times with no delays between packets
 Diminished throughput and increased latency

Required Parameter Values (TX modem): MT (Multi-Transmit) >= 1

Other Related Commands: Networking (DT, MK, MY, RN, TT), Serial Interfacing (BR, PK, RB, RO), RF Interfacing (FS)

Recommended Use: Use for applications that require Reliable Delivery without using retries and acknowledgements.

Connection Sequence

Figure 5-05. Multi-Transmit Mode State Diagram (TX Module)

In Multi-Transmit Mode, each packet is retransmitted MT times, for a total of (MT+1) transmissions. There is no delay between retransmissions, and the TX (transmitting) modem will never receive RF data between retransmissions. Each retransmission includes an RF initializer. A transmission event may include follow-on packets, each of which will be retransmitted MT times. The Forced Sync (FS) parameter is ignored in Multi-Transmit Mode.

The RB and RO parameters are not applied to follow-on packets, meaning that once transmission has begun, it will continue uninterrupted until the DI buffer is empty or the streaming limit (TT parameter) has been reached. As with the first packet, the payload of each follow-on packet includes up to the maximum packet size (PK parameter) bytes, and the TX modem checks for more pending data near the end of each packet. Follow-on packets are not sent until all retransmissions of the previous packet are finished.

The streaming limit (TT) is specified at the TX modem as the maximum number of bytes that the TX modem can send in one transmission event, which may consist of many packets. If the TT parameter is reached, the TX modem will force a random delay of 1 to RN delay slots (exactly 1 delay slot if RN is zero). In Multi-Transmit Mode, each packet is counted only once when tracking the streaming limit (TT), no matter how many times it is retransmitted.

When an RX (receiving) module receives a Multi-Transmit packet, it calculates the amount of time remaining in the Multi-Transmit event, and inhibits its own transmissions for the duration of the Multi-Transmit event, plus a random number of delay slots between 0 and (RN-1). If the local RN parameter is zero, the delay is only for the calculated duration of the Multi-Transmit event. Thus, an RX modem need only receive one of the transmissions, and it will keep off the channel until the TX modem is done. If follow-on packets are coming, the RX modems will move to the new frequency and listen for the follow-on packet for a specific period of time.

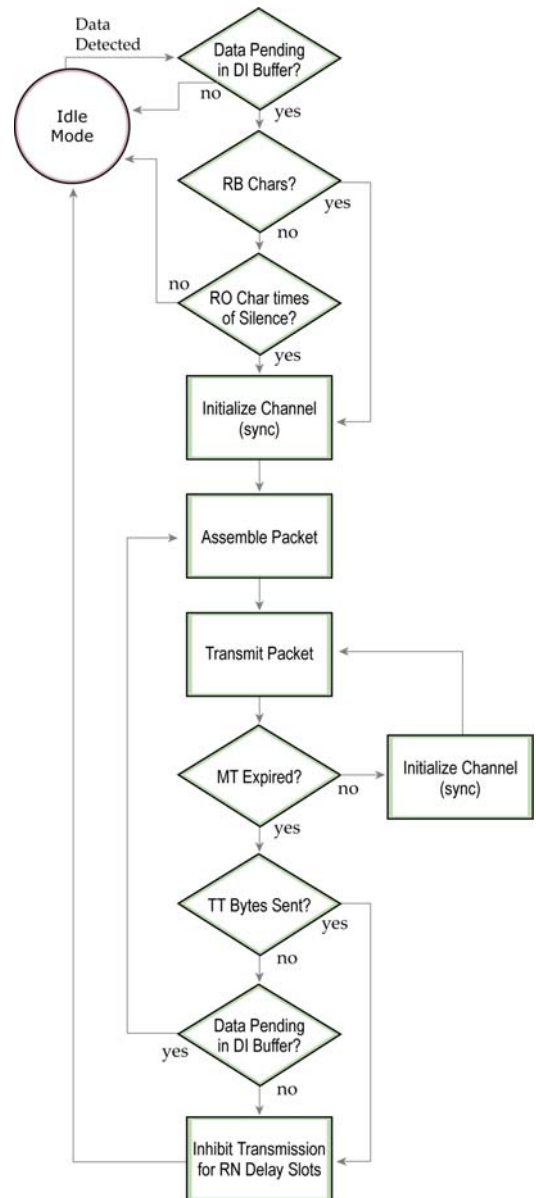

5.2.3. Repeater Mode

- Attributes:** Low power consumption
 Minimized interference
 Each RF packet is tagged with a unique Packet ID (PID).
 Each repeater will repeat a packet only once (tracked by the PID).
 Increased latency and decreased throughput
 (Latency and throughput is determined by number of hops, not by number of repeaters. Multiple repeaters within range of source node count as one hop.)
 All RF packets propagate to every modem in the network (filtering rules apply).
 Packet destination addresses (DT) determine which packets are sent out serial port and/or retransmitted.
 Broadcast communications - each packet comes out every node exactly once.
 Addressed communications - all modems see every packet. Only the modem with a matching address will forward it to the DO buffer (UART IN).
- Constraints:** Requires that each modem have a unique MY (Source Address) parameter.
 System must introduce just one packet at a time to the network for transmission (Maximum number of bytes is determined by the PK parameter).
 Each hop (H) decreases network throughput by a factor of $1/(H+1)$. Additional repeaters add network redundancy without decreasing throughput.
- Suggestions:** Insert a variable delay before repeating packets to avoid collisions (based on RSSI).
 Buffer any incoming serial data and delay response packet transmissions until previous packet has cleared out of network.
 For best results, use the RO and RB commands to ensure that the RF packets align with the underlying protocol packets as the network can only accept one RF packet at a time.

Required Parameter Values (TX modem): MD = 5 or 6, MY = unique value (can be accomplished by issuing the AM (Auto-set MY) and WR (Write) commands to all modems in the network)

Related Commands: Networking (MD, DT, MY, AM), Serial Interfacing (RN, PK, RO, RB)

Recommended Use: Use in networks where intermediary modems are needed to relay data to modems beyond the transmission range of the base modem.

Theory of Operation

OEMs and integrators can extend the effective range and reliability of their data radio system by forwarding traffic through one or more repeaters. Instead of using routing tables and path discovery to establish dynamic paths through a network, the repeater system uses a sophisticated algorithm to propagate each RF packet through the entire network.

The network supports RF packets up to 2048 bytes (when the RF data rate is set at 9600 bps (BR = 0)). The repeater network can operate using broadcast or addressed communications for multi-drop networks and works well in many systems with no special configuration.

When in Repeater Mode, the network repeats each message among all available modems exactly one time. This mechanism eliminates the need for configuring specific routes.

Figure 5-06. Repeater Network Topology

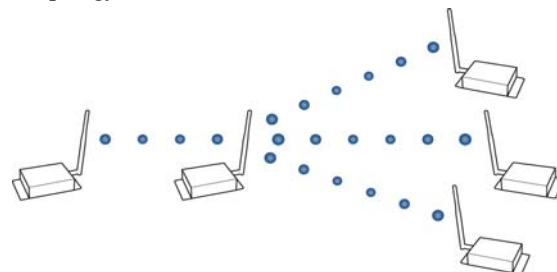

Repeater Network Configuration

A network may consist of End Nodes (EN), End/Repeater Nodes (ERN) and a Base Node (BN). The base node initiates all communications.

A repeater network can be configured to operate using Basic Broadcast or Basic Addressed communications. The addressing capabilities of the modem allow integrators to send a packet as a global packet (DT = 0xFFFF) and shift out of every modem in the network (Basic Broadcast). Alternatively, the packet can be sent with a specific DT (Destination Address) parameter so that it is only accepted by a specific remote node (Basic Addressed).

Configuration Instruction (Basic Broadcast Communications)

Assign each modem a unique MY (source) address. (The AM (Auto-set MY) command will configure a unique source address that is based on modem serial number.)

Enable Basic Broadcast Communications (DT = 0xFFFF) or Addressed Broadcast Communications (DT specifies a specific destination)

Configure PK, RO and RB to ensure that RF packet aligns with protocol packet. (ex. PK=0x100, RB=0x100, RO depends on baud rate).

Configure one or more repeaters in the system (MD = 5).

Configure remote nodes as destinations (MD = 6). This will ensure that the remote node waits for the repeater traffic to subside before it transmits a response.

The configuration instructions above reflect configuration for a Basic Broadcast Repeater system. To configure a Basic Addressed Repeater system, use the DT (Destination Address) parameter to assign unique addresses to each modem in the network.

Algorithm Details

- Packet ID (PID) is composed of TX (transmitting) modem MY address and packet sequence number.
- Incoming packets with a PID already found in the PID buffer will be ignored.
- Each modem maintains a PID buffer 4 deep of previously received packets (managed as FIFO).

Packets may be shifted out the serial port and/or repeated depending on the DT parameter contained in the RF packet.

Table 5-02. DT (Destination Address) parameter truth table

Address Match	Send out serial port?	Repeat?
Global	Yes	Yes
Local	Yes	No
None	No	Yes

Repeat Delay Based on RSSI

A transmitted packet may be received by more than one repeater at the same time. In order to reduce the probability that the repeaters will transmit at the same instant, resulting in a collision and possible data loss; an algorithm has been developed that will allow a variable back-off prior to retransmission of the packet by a repeater. The algorithm allows radios that receive the packet with a stronger RF signal (RSSI) to have the first opportunity to retransmit the packet.

The RN (Delay Slots) parameter is used to configure this delay. Set RN=0 (no delays) for small networks with few repeaters or repeaters that are not within range of each other. Set RN=1 for systems with 2 to 5 repeaters that may be within range of each other.

The actual length of the delay is computed by the formula:

$$\text{Delay (ms)} = L * DS$$

$$DS = (-41 - \text{RSSI}) / 10 * RN + \text{RandomInt}(0, RN)$$

Where L is the length of the transmitted packet in milliseconds, DS is the number of delay slots to wait, RSSI is the received signal strength in dBm, RN is the value of the RN register and RandomInt(A,B) is a function that returns a random integer from A to B-0

Response Packet Delay

As a packet propagates through the repeater network, if any node receives the data and generates a quick response, the response needs to be delayed so as not to collide with subsequent retransmissions of the original packet. To reduce collisions, both repeater and end node radios in a repeater network will delay transmission of data shifted in the serial port to allow any repeaters within range to complete their retransmissions.

The time for this delay is computed by the formula:

$$\text{Maximum Delay (ms)} = L * DS$$

$$DS = ((-41 - (-100)) / 10) * RN + RN + 1$$

Where L is the length of the transmitted packet in milliseconds, DS is the number of delay slots to wait, RSSI is the received signal strength in dBm, and RN is the value of the RN register.

Use Case - Broadcast Repeater Network

Consider modems R1 through R10 each communicating to a PLC using the ModBus protocol and spaced evenly in a line. All ten modems are configured as 'destinations & repeaters' within the scope of Basic Broadcast Communications (MD=5, AM, DT=0xFFFF, PK=0x100, RO=0x03, RB=0x100, RN=1). The Base Host (BH) shifts payload that is destined for R10 to R1. R1 initializes RF communication and transmits payload to nodes R2 through R5 which are all within range of R1. The modems R2 through R5 receive the RF packet and retransmit the packet simultaneously. They also send the data out the serial ports, to the PLCs.

Table 5-03. Commands used to configure repeater functions

AT Command	Binary Command	AT Command Name	Range	# Bytes Returned	Factory Default
AM	0x3A (58d)	Auto-set MY	-	-	-
DT	0x00 (0d)	Destination Address	0 - 0xFFFF	2	0
MD	0x3C (60d)	RF Mode	0 - 6	1	0
MY	0x2A (42d)	Source Address	0 - 0xFFFF	2	0xFFFF
RN	0x19 (25d)	Delay Slots	0 - 0xFF [slots]	1	0
WR	0x08 (8d)	Write	-	-	-

Bandwidth Considerations

Using broadcast repeaters in a network reduces the overall network data throughput as each repeater must buffer an entire packet before retransmitting it. For example: if the destination is within range of the transmitter and the packet is 32-bytes long, the transmission will take 12ms on an XTend modem operating at 115,200 baud. If the same packet must propagate through two repeaters, it will take 12ms to arrive at the first repeater, 12ms to get to the second and a final 12ms to reach the destination for a total of 36ms. Taking into account UART transfer times (~1ms/byte at 9600 baud), a server to send a 32-byte query and receive a 32-byte response is about 200ms, allowing for 5 polls per second. With the two repeaters in the path, the same query/response sequence would take about 500ms for 2 polls per second.

Generally, network throughput will decrease by a factor of 1/(R+1), with R representing the number of repeaters between the source and destination.

5.2.4. Polling Mode (Basic)

NOTE: Polling Mode (Basic) and Polling Mode (Acknowledged) [p55] operate in the same way. The only difference between the two modes is in their means of achieving reliable delivery of data. In Polling Mode (Basic), reliable delivery is achieved using multiple transmissions.

Attributes:

- Utilizes high percentage of available network bandwidth
- Eliminates collisions
- Works with reliable delivery (RR or MT parameters)
- Supports binary data transfers
- Base modem requests packets from remote modem by polling a sequential range of addresses
- Base modem is configured to specify the range of addresses being polled
- Uses inter-character delay to create RF packet lengths aligned with protocol packet lengths up to 2048 bytes long.

Required Parameter Values (Base): MD (RF Mode) = 3, PB (Polling Begin Address), PE (Polling End Address)

Required Parameter Value (Remote): MD (RF Mode) = 4

Related Commands: Networking (MT, PD, DT, MY, AM)

Constraints: The minimum time interval between polling cycles is configurable. However, if the remote modems cannot all be processed within that time interval, the polling cycle is ineffective (i.e. it will impose no additional delay). In order to ensure a pause between polling cycles, PD must be set to a value which is large enough to accommodate the pause.

Recommended Use: Use for point-to-multipoint applications that require Reliable Delivery of data. Use this mode when it is critical that a base modem be able to discern data coming from multiple modems.

Theory of Operation

A 'Polling Base' modem will cycle through a sequential range of addresses. The 'Polling Base' will poll each 'Polling Remote' modem, wait for a response, then poll the next remote address in the sequence. Each 'Polling Remote' will respond by sending the data from its DI (Data In) buffer following the RB (Packetization Threshold) & RO (Packetization Timeout) parameters. When there is no eligible data to send, the 'Polling Remote' will not respond. The 'Polling Base' will poll the next address in the polling sequence after a short delay.

Polling Base Configuration:

Set the MD (RF Mode) parameter (MD = 3).

Set MY (Source Address) parameter (MY = 0).

Set the sequential range of Polling Addresses using the PB (Polling Begin Address) and PE (Polling End Address) parameters.

(Optional) Enable Basic Reliable Delivery (MT >= 0). Note: Acknowledged Reliable Delivery is also supported. Refer to the 'Polling Mode - Acknowledged' section for more information.

(Optional) Use the PD (Minimum Polling Delay) command to configure a delay between polls to slow down system (if needed).

(Optional) Enable API Mode to address remotes within polling range on a packet-by-packet basis.

Polling Remote Configuration:

Set the MD (RF Mode) parameter (MD = 4).

Configure sequential source addresses for all remote modems using the MY (Source Address) command.

Set the DT (Destination Address) parameter to point to 'Polling Base' (DT = 0x0000).

(Optional) Enable Basic Reliable Delivery (MT >= 0). Note: Acknowledged Reliable Delivery is also supported. Refer to the 'Polling Mode - Acknowledged' section for more information.

5.3. Acknowledged Communications

5.3.1. Acknowledged Mode

Attributes: Reliable delivery through positive acknowledgements for each packet
Throughput, latency and jitter vary depending on the quality of the channel and the strength of the signal.

Required Parameter Values (TX modem): RR (Retries) ≥ 1

Related Commands: Networking (DT, MK, RR), Serial Interfacing (PK, RN, RO, RB, TT)

Recommended Use: Use for applications that require Reliable Delivery. If messages are smaller than 256 bytes, use RB and RO commands to align RF packets to application packets.

Connection Sequence

Figure 5-07. Acknowledged Mode State Diagram (TX modem)

After sending a packet while in Acknowledged Mode, the TX (transmitting) modem listens for an ACK (acknowledgement). If it receives the ACK, it will either move on to sending a subsequent packet (if more transmit data is pending) or will wait for exactly RN random delay slots before allowing another transmission (if no more data is pending to be transmitted).

If the TX modem does not receive the ACK within the allotted time, it will retransmit the packet with a new RF initializer following the ACK slot. There is no delay between the first ACK slot and the first retransmission. Subsequent retransmissions incur a delay of a random number of delay slots, between 0 and RN. If RN is set to 0 on the TX modem, there are never any back-off delays between retransmissions. Note that during back-off delays, the TX modem will go into Idle Mode and may receive RF data. This can have the effect of increasing the back-off delay, as the modem cannot return to Transmit (or retransmit) Mode as long as it is receiving RF data.

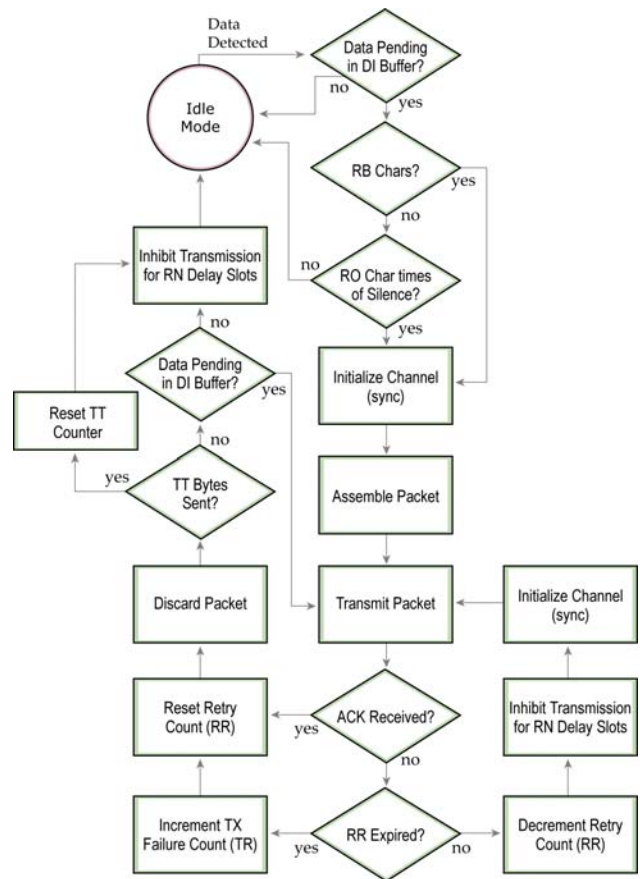

After receiving and acknowledging a packet, the RX (receiving) modem will move to the next frequency and listen for either a retransmission or new data for a specific period of time. Even if the TX modem has indicated that it has no more pending transmit data, it may not have received the previous ACK, and so may retransmit the packet, possibly with no delay after the ACK slot. In this case, the RX modem will always detect the immediate retransmission, which will hold off the communications channel and thereby reduce collisions. RX modems acknowledge each retransmission they receive, but they only pass the first copy of a packet they receive out the UART.

RB and RO parameters are not applied to subsequent packets, meaning that once transmission has begun, it will continue uninterrupted until the DI buffer is empty or the streaming limit (TT parameter) has been reached. As with the first packet, the payload of each subsequent packet includes up to the maximum packet size (PK parameter), and the TX modem checks for more pending data near the end of each packet.

The TT parameter (streaming limit) specifies the maximum number of bytes that the TX modem will send in one transmission event, which may consist of many packets and retries. If the TT parameter is reached, the TX modem will force a random delay of 1 to RN delay slots (exactly 1 delay slot if RN is zero). Each packet is counted only once toward TT, no matter how many times the packet is retransmitted.

Subsequent packets in Acknowledged Mode are similar to those in Streaming Mode, with the addition of an ACK between each packet, and the possibility of retransmissions. Subsequent packets are sent without an RF initializer, as the RX modems are already synchronized to the TX modem from the preceding packet(s) and they remain synchronized for the duration of the transmission event. Each retransmission of a packet includes an RF initializer.

Once the TX modem has sent all pending data or has reached the TT limit, the acknowledged transmission event is completed. The TX modem will not transmit again for exactly RN delay slots, if the local RN parameter is set to a non-zero value. The RX modem will not transmit for a random number of delay slots between 0 and (RN-1), if the local RN parameter is set to a non-zero value. These delays are intended to lessen congestion following long bursts of packets from a single TX modem, during which several RX modems may have themselves become ready to transmit.

5.3.2. Polling Mode (Acknowledged)

NOTE: Polling Mode (Acknowledged) and Polling Mode (Basic) [p52] operate in the same way. The only difference between the two modes is in their means of achieving reliable delivery of data. In Polling Mode (Acknowledged), reliable delivery is achieved using retries and acknowledgements.

Attributes:

- Utilizes high percentage of available network bandwidth
- Eliminates collisions
- Works with reliable delivery (RR or MT parameters)
- Supports binary data transfers
- Base modem requests packets from remote modem by polling a sequential range of addresses
- Base modem is configured to specify the range of addresses being polled
- Uses inter-character delay to create RF packet lengths aligned with protocol packet lengths up to 2048 bytes long.

Required Parameter Values (Base): MD (RF Mode) = 3, PB (Polling Begin Address), PE (Polling End Address)

Required Parameter Values (Remote): MD (RF Mode) = 4

Related Commands: Networking (RR, PD, DT, MY, AM)

Constraints: The minimum time interval between polling cycles is configurable. However, if the remote modems cannot all be processed within that time interval, the polling cycle is ineffective (i.e. it will impose no additional delay). In order to ensure a pause between polling cycles, PD must be set to a value which is large enough to accommodate the pause.

Recommended Use: Use for point-to-multipoint applications that require Reliable Delivery of data. Use this mode when it is critical that a base modem be able to discern data coming from multiple modems.

Theory of Operation

A 'Polling Base' modem will cycle through a sequential range of addresses. The 'Polling Base' will poll each 'Polling Remote' modem, wait for a response, then poll the next remote address in the sequence. Each 'Polling Remote' will respond by sending the data from its DI (Data In) buffer following the RB (Packetization Threshold) & RO (Packetization Timeout) parameters. When there is no eligible data to send, the 'Polling Remote' will not respond. The 'Polling Base' will poll the next address in the polling sequence after a short delay.

Polling Base Configuration:

Set the MD (RF Mode) parameter (MD = 3).

Set MY (Source Address) parameter (MY = 0).

Set the sequential range of Polling Addresses using the PB (Polling Begin Address) and PE (Polling End Address) parameters.

(Optional) Enable Acknowledged Reliable Delivery (RR >= 0). Note: Basic Reliable Delivery is also supported. Refer to the 'Polling Mode - Basic' section for more information.

(Optional) Use the PD (Minimum Polling Delay) command to configure a delay between polls to slow down system (if needed).

(Optional) Enable API Mode to address remotes within polling range on a packet-by-packet basis.

Polling Remote Configuration:

Set the MD (RF Mode) parameter (MD = 4).

Configure sequential source addresses for all remote modems using the MY (Source Address) command.

Set the DT (Destination Address) parameter to point to 'Polling Base' (DT = 0x0000).

(Optional) Enable Acknowledged Reliable Delivery (RR >= 0). Note: Basic Reliable Delivery is also supported. Refer to the 'Polling Mode - Basic' section for more information.

Appendix A: Agency Certifications

FCC (United States) Certification

The XTend Ethernet RF Modem complies with Part 15 of the FCC rules and regulations. Compliance with the labeling requirements, FCC notices and antenna usage guidelines is required.

In order to operate under MaxStream's FCC Certification, OEMs/integrators must comply with the following regulations:

1. The OEM/integrator must ensure that the text provided with this device [Figure A-01] is placed on the outside of the final product and within the final product operation manual.
2. The XTend Ethernet RF Modem may only be used with antennas that have been tested and approved for use with this modem [refer to 'FCC-approved Antennas' section].

Labeling Requirements



WARNING: The Original Equipment Manufacturer (OEM) must ensure that FCC labeling requirements are met. This includes a clearly visible label on the outside of the final product enclosure that displays the text shown in the figure below.

Figure A-01. Required FCC Label for OEM products containing the XTend Ethernet RF Modem

Contains FCC ID: OUR-9XTEND

The enclosed device complies with Part 15 of the FCC Rules. Operation is subject to the following two conditions: (i.) this device may not cause harmful interference and (ii.) this device must accept any interference received, including interference that may cause undesired operation.

FCC Notices

IMPORTANT: The XTend Ethernet RF Modem has been certified by the FCC for use with other products without any further certification (as per FCC section 2.1091). Modifications not expressly approved by MaxStream could void the user's authority to operate the equipment.

IMPORTANT: OEMs must test final product to comply with unintentional radiators (FCC section 15.107 & 15.109) before declaring compliance of their final product to Part 15 of the FCC Rules.

IMPORTANT: The RF modem has been certified for remote and base radio applications. If the modem will be used for portable applications, the device must undergo SAR testing.

This equipment has been tested and found to comply with the limits for a Class B digital device, pursuant to Part 15 of the FCC Rules. These limits are designed to provide reasonable protection against harmful interference in a residential installation. This equipment generates, uses and can radiate radio frequency energy and, if not installed and used in accordance with the instructions, may cause harmful interference to radio communications. However, there is no guarantee that interference will not occur in a particular installation.

If this equipment does cause harmful interference to radio or television reception, which can be determined by turning the equipment off and on, the user is encouraged to try to correct the interference by one or more of the following measures: Re-orient or relocate the receiving antenna, Increase the separation between the equipment and receiver, Connect equipment and receiver to outlets on different circuits, or Consult the dealer or an experienced radio/TV technician for help.

Limited Modular Approval

Power output is conducted at the antenna terminal and can be adjusted from 1 mill-watt to 1 Watt at the OEM level. This is an RF modem approved for Limited Modular use operating as a mobile transmitting device with respect to section 2.1091 and is limited to OEM installation for Mobile and Fixed applications only. During final installation, end-users are prohibited from access to any programming parameters. Professional installation adjustment is required for setting module power and antenna gain to meet EIRP compliance for high gain antenna(s).

Final antenna installation and operating configurations of this transmitter including antenna gain and cable loss must not exceed the EIRP of the configuration used for calculating MPE. Grantee (MaxStream) must coordinate with OEM integrators to ensure the end-users and installers of products operating with the modem are provided with operating instructions to satisfy RF exposure requirements.

The FCC grant is valid only when the device is sold to OEM integrators. Integrators are instructed to ensure the end-user has no manual instructions to remove, adjust or install the device.

FCC-approved Antennas



WARNING: This device has been tested with Reverse Polarity SMA connectors with the antennas listed in the tables of this section. When integrated into OEM products, fixed antennas require installation preventing end-users from replacing them with non-approved antennas. Antennas not listed in the tables must be tested to comply with FCC Section 15.203 (unique antenna connectors) and Section 15.247 (emissions).

Fixed Base Station and Mobile Applications

MaxStream RF Modems are pre-FCC approved for use in fixed base station and mobile applications. When the antenna is mounted at least 20cm (8") from nearby persons, the application is considered a mobile application.

Portable Applications and SAR Testing

When the antenna is mounted closer than 20cm to nearby persons, then the application is considered "portable" and requires an additional test be performed on the final product. This test is called Specific Absorption Rate (SAR) testing and measures the emissions from the modem and how they affect the person.

RF Exposure

This statement must be included as a CAUTION statement in OEM product manuals.



WARNING: This equipment is approved only for mobile and base station transmitting devices. Antenna(s) used for this transmitter must be installed to provide a separation distance of at least 30 cm from all persons and must not be co-located or operating in conjunction with any other antenna or transmitter.

NOTE: The separation distance indicated in the above is 30 cm, but any distance greater than or equal to 23 cm can be used (per MPE evaluation).

Antenna Options (1-watt transmit power output or lower)**Table A-01. Half-wave antennas (approved when operating at 1-watt power output or lower)**

Part Number	Type	Connector	Gain	Application
A09-HSM-7	Straight half-wave	RPSMA	3.0 dBi	Fixed / Mobile
A09-HASM-675	Articulated half-wave	RPSMA	2.1 dBi	Fixed / Mobile
A09-HABMM-P6I	Articulated half-wave w/ 6" pigtail	MMCX	2.1 dBi	Fixed / Mobile
A09-HABMM-6-P6I	Articulated half-wave w/ 6" pigtail	MMCX	2.1 dBi	Fixed / Mobile
A09-HBMM-P6I	Straight half-wave w/ 6" pigtail	MMCX	2.1 dBi	Fixed / Mobile
A09-HRSM	Right angle half-wave	RPSMA	2.1 dBi	Fixed
A09-HASM-7	Articulated half-wave	RPSMA	2.1 dBi	Fixed
A09-HG	Glass mounted half-wave	RPSMA	2.1 dBi	Fixed
A09-HATM	Articulated half-wave	RPTNC	2.1 dBi	Fixed
A09-H	Half-wave dipole	RPSMA	2.1 dBi	Fixed

Table A-02. Yagi antennas (approved when operating at 1-watt power output or lower)

Part Number	Type	Connector	Gain	Required Antenna Cable Loss	Application
A09-Y6	2 Element Yagi	RPN	6.1 dBi	0.1 dB*	Fixed / Mobile
A09-Y7	3 Element Yagi	RPN	7.1 dBi	1.1 dB*	Fixed / Mobile
A09-Y8	4 Element Yagi	RPN	8.1 dBi	2.1 dB*	Fixed / Mobile
A09-Y6TM	2 Element Yagi	RPTNC	6.1 dBi	0.1 dB*	Fixed / Mobile
A09-Y7TM	3 Element Yagi	RPTNC	7.1 dBi	1.1 dB*	Fixed / Mobile
A09-Y8TM	4 Element Yagi	RPTNC	8.1 dBi	2.1 dB*	Fixed / Mobile

Table A-03. Omni-directional base station antennas (approved when operating at 1-watt power output or lower)

Part Number	Type	Connector	Gain	Required Antenna Cable Loss	Application
A09-F0	Fiberglass Base Station	RPN	0 dBi	-	Fixed
A09-F1	Fiberglass Base Station	RPN	1.0 dBi	-	Fixed
A09-F2	Fiberglass Base Station	RPN	2.1 dBi	-	Fixed
A09-F3	Fiberglass Base Station	RPN	3.1 dBi	-	Fixed
A09-F4	Fiberglass Base Station	RPN	4.1 dBi	-	Fixed
A09-F5	Fiberglass Base Station	RPN	5.1 dBi	-	Fixed
A09-F6	Fiberglass Base Station	RPN	6.1 dBi	0.1 dB*	Fixed
A09-F7	Fiberglass Base Station	RPN	7.1 dBi	1.1 dB*	Fixed
A09-F8	Fiberglass Base Station	RPN	8.1 dBi	2.1 dB*	Fixed
A09-W7	Wire Base Station	RPN	7.1 dBi	1.1 dB*	Fixed
A09-F0	Fiberglass Base Station	RPSMA	0 dBi	-	Fixed
A09-F1	Fiberglass Base Station	RPSMA	1.0 dBi	-	Fixed
A09-F2	Fiberglass Base Station	RPSMA	2.1 dBi	-	Fixed
A09-F3	Fiberglass Base Station	RPSMA	3.1 dBi	-	Fixed
A09-F4	Fiberglass Base Station	RPSMA	4.1 dBi	-	Fixed
A09-F5	Fiberglass Base Station	RPSMA	5.1 dBi	-	Fixed
A09-F6	Fiberglass Base Station	RPSMA	6.1 dBi	0.1 dB*	Fixed
A09-F7	Fiberglass Base Station	RPSMA	7.1 dBi	1.1 dB*	Fixed
A09-F8	Fiberglass Base Station	RPSMA	8.1 dBi	2.1 dB*	Fixed
A09-W7SM	Wire Base Station	RPSMA	7.1 dBi	1.1 dB*	Fixed
A09-F0TM	Fiberglass Base Station	RPTNC	0 dBi	-	Fixed
A09-F1TM	Fiberglass Base Station	RPTNC	1.0 dBi	-	Fixed
A09-F2TM	Fiberglass Base Station	RPTNC	2.1 dBi	-	Fixed
A09-F3TM	Fiberglass Base Station	RPTNC	3.1 dBi	-	Fixed
A09-F4TM	Fiberglass Base Station	RPTNC	4.1 dBi	-	Fixed
A09-F5TM	Fiberglass Base Station	RPTNC	5.1 dBi	-	Fixed
A09-F6TM	Fiberglass Base Station	RPTNC	6.1 dBi	0.1 dB*	Fixed
A09-F7TM	Fiberglass Base Station	RPTNC	7.1 dBi	1.1 dB*	Fixed
A09-F8TM	Fiberglass Base Station	RPTNC	8.1 dBi	2.1 dB*	Fixed
A09-W7TM	Wire Base Station	RPTNC	7.1 dBi	1.1 dB*	Fixed

* FCC regulations stipulate a 36 dBm EIRP power requirement. Users implementing antenna gain greater than 6.0 dB must compensate for the added gain with cable loss. When operating at 1 W power output, the sum (in dB) of cable loss and antenna gain shall not exceed 6.0 dB.

Table A-04. Mag Mount antennas (approved when operating at 1-watt power output or lower)

Part Number	Type	Connector	Gain	Required Antenna Cable Loss	Application
A09-M0SM	Mag Mount	RPSMA	0 dBi	-	Fixed
A09-M2SM	Mag Mount	RPSMA	2.1 dBi	-	Fixed
A09-M3SM	Mag Mount	RPSMA	3.1 dBi	-	Fixed
A09-M5SM	Mag Mount	RPSMA	5.1 dBi	-	Fixed
A09-M7SM	Mag Mount	RPSMA	7.1 dBi	-1.1 dB*	Fixed
A09-M8SM	Mag Mount	RPSMA	8.1 dBi	-2.1 dB*	Fixed
A09-M0TM	Mag Mount	RPTNC	0 dBi	-	Fixed
A09-M2TM	Mag Mount	RPTNC	2.1 dBi	-	Fixed
A09-M3TM	Mag Mount	RPTNC	3.1 dBi	-	Fixed
A09-M5TM	Mag Mount	RPTNC	5.1 dBi	-	Fixed
A09-M7TM	Mag Mount	RPTNC	7.1 dBi	-1.1 dB*	Fixed
A09-M8TM	Mag Mount	RPTNC	8.1 dBi	-2.1 dB*	Fixed

Table A-05. Multi-path antennas (approved when operating at 1-watt power output or lower)

Part Number	Type	Connector	Gain	Application
A09-DPSM-P12F	omni directional permanent mount w/ 12ft pigtail	RPSMA	3.0 dBi	Fixed
A09-D3NF-P12F	omni directional magnetic mount w/ 12ft pigtail	RPN	3.0 dBi	Fixed
A09-D3SM-P12F	omni directional w/ 12ft pigtail	RPSMA	3.0 dBi	Fixed
A09-D3PNF	omni directional permanent mount	RPN	3.0 dBi	Fixed
A09-D3TM-P12F	omni directional w/ 12ft pigtail	RPTNC	3.0 dBi	Fixed
A09-D3PTM	omni directional permanent mount	RPTNC	3.0 dBi	Fixed
A92-D4PNF	900 MHz / 2.4GHz permanent mount	RPN	2.1 dBi	Fixed
A92-D4P	900 MHz / 2.4GHz permanent mount	RPSMA	2.1 dBi	Fixed
A92-D4PTM	900 MHz / 2.4GHz permanent mount	RPTNC	2.1 dBi	Fixed

* FCC regulations stipulate a 36 dBm EIRP power requirement. Users implementing antenna gain greater than 6.0 dB must compensate for the added gain with cable loss. When operating at 1 W power output, the sum (in dB) of cable loss and antenna gain shall not exceed 6.0 dB.

Antenna Options (100 mW transmit power output or lower)

Table A-06. Half-wave antennas (approved when operating at 100 mW power output or lower)

Part Number	Type	Connector	Gain	Application
A09-QW	Quarter-wave wire	Permanent	1.9 dBi	Fixed / Mobile
A09-QRAMM	3" Quarter-wave wire	MMCX	2.1 dBi	Fixed / Mobile
A09-QSM-3	Quarter-wave straight	RPSMA	1.9 dBi	Fixed / Mobile
A09-QSM-3H	Heavy duty quarter-wave straight	RPSMA	1.9 dBi	Fixed / Mobile
A09-QBMM-P6I	Quarter-wave w/ 6" pigtail	MMCX	1.9 dBi	Fixed / Mobile
A09-QHRN	Miniature Helical Right Angle solder	Permanent	-1 dBi	Fixed / Mobile
A09-QHSN	Miniature Helical Right Angle solder	Permanent	-1 dBi	Fixed / Mobile
A09-QHSM-2	2" Straight	RPSMA	1.9 dBi	Fixed / Mobile
A09-QHRSM-2	2" Right angle	RPSMA	1.9 dBi	Fixed / Mobile
A09-QHRSM-170	1.7" Right angle	RPSMA	1.9 dBi	Fixed / Mobile
A09-QRSM-380	3.8" Right angle	RPSMA	1.9 dBi	Fixed / Mobile
A09-QAPM-520	5.2" Articulated Screw mount	Permanent	1.9 dBi	Fixed / Mobile
A09-QSPM-3	3" Straight screw mount	Permanent	1.9 dBi	Fixed / Mobile
A09-QAPM-3	3" Articulated screw mount	Permanent	1.9 dBi	Fixed / Mobile
A09-QAPM-3H	3" Articulated screw mount	Permanent	1.9 dBi	Fixed / Mobile

Table A-07. Yagi antennas (approved when operating at 100 mW power output or lower)

Part Number	Type	Connector	Gain	Application
A09-Y6	2 Element Yagi	RPN	6.1 dBi	Fixed / Mobile
A09-Y7	3 Element Yagi	RPN	7.1 dBi	Fixed / Mobile
A09-Y8	4 Element Yagi	RPN	8.1 dBi	Fixed / Mobile
A09-Y9	4 Element Yagi	RPN	9.1 dBi	Fixed / Mobile
A09-Y10	5 Element Yagi	RPN	10.1 dBi	Fixed / Mobile
A09-Y11	6 Element Yagi	RPN	11.1 dBi	Fixed / Mobile
A09-Y12	7 Element Yagi	RPN	12.1 dBi	Fixed / Mobile
A09-Y13	9 Element Yagi	RPN	13.1 dBi	Fixed / Mobile
A09-Y14	10 Element Yagi	RPN	14.1 dBi	Fixed / Mobile
A09-Y14	12 Element Yagi	RPN	14.1 dBi	Fixed / Mobile
A09-Y15	13 Element Yagi	RPN	15.1 dBi	Fixed / Mobile
A09-Y15	15 Element Yagi	RPN	15.1 dBi	Fixed / Mobile
A09-Y6TM	2 Element Yagi	RPTNC	6.1 dBi	Fixed / Mobile
A09-Y7TM	3 Element Yagi	RPTNC	7.1 dBi	Fixed / Mobile
A09-Y8TM	4 Element Yagi	RPTNC	8.1 dBi	Fixed / Mobile
A09-Y9TM	4 Element Yagi	RPTNC	9.1 dBi	Fixed / Mobile
A09-Y10TM	5 Element Yagi	RPTNC	10.1 dBi	Fixed / Mobile
A09-Y11TM	6 Element Yagi	RPTNC	11.1 dBi	Fixed / Mobile
A09-Y12TM	7 Element Yagi	RPTNC	12.1 dBi	Fixed / Mobile
A09-Y13TM	9 Element Yagi	RPTNC	13.1 dBi	Fixed / Mobile
A09-Y14TM	10 Element Yagi	RPTNC	14.1 dBi	Fixed / Mobile
A09-Y14TM	12 Element Yagi	RPTNC	14.1 dBi	Fixed / Mobile
A09-Y15TM	13 Element Yagi	RPTNC	15.1 dBi	Fixed / Mobile
A09-Y15TM	15 Element Yagi	RPTNC	15.1 dBi	Fixed / Mobile

IC (Industry Canada) Certification

Labeling Requirements

Labeling requirements for Industry Canada are similar to those of the FCC. A clearly visible label on the outside of the final product enclosure must display the following text:

Contains Model 9XTend Radio, IC: 4214A-9XTEND

The integrator is responsible for its product to comply with IC ICES-003 & FCC Part 15, Sub. B - Unintentional Radiators. ICES-003 is the same as FCC Part 15 Sub. B and Industry Canada accepts FCC test report or CISPR 22 test report for compliance with ICES-003.

C-TICK (Australia) Certification

Power Requirements

Regulations in Australia stipulate a maximum of 30 dBm EIRP (Effective Isotropic Radiated Power). The EIRP equals the sum (in dBm) of power output, antenna gain and cable loss and cannot not exceed 30 dBm.

Figure A-02. EIRP Formula for Australia

$$\text{Power Output} + \text{Antenna Gain} - \text{Cable Loss} \leq 30 \text{ dBm}$$

NOTE: The maximum EIRP for the FCC (United States) and IC (Canada) is 36 dBm.

Appendix B: Additional Information

1-Year Warranty

XTend RF Modems from MaxStream, Inc. (the "Product") are warranted against defects in materials and workmanship under normal use, for a period of 1-year from the date of purchase. In the event of a product failure due to materials or workmanship, MaxStream will repair or replace the defective product. For warranty service, return the defective product to MaxStream, shipping pre-paid, for prompt repair or replacement.

The foregoing sets forth the full extent of MaxStream's warranties regarding the Product. Repair or replacement at MaxStream's option is the exclusive remedy. THIS WARRANTY IS GIVEN IN LIEU OF ALL OTHER WARRANTIES, EXPRESS OR IMPLIED, AND MAXSTREAM SPECIFICALLY DISCLAIMS ALL WARRANTIES OF MERCHANTABILITY OR FITNESS FOR A PARTICULAR PURPOSE. IN NO EVENT SHALL MAXSTREAM, ITS SUPPLIERS OR LICENSORS BE LIABLE FOR DAMAGES IN EXCESS OF THE PURCHASE PRICE OF THE PRODUCT, FOR ANY LOSS OF USE, LOSS OF TIME, INCONVENIENCE, COMMERCIAL LOSS, LOST PROFITS OR SAVINGS, OR OTHER INCIDENTAL, SPECIAL OR CONSEQUENTIAL DAMAGES ARISING OUT OF THE USE OR INABILITY TO USE THE PRODUCT, TO THE FULL EXTENT SUCH MAY BE DISCLAIMED BY LAW. SOME STATES DO NOT ALLOW THE EXCLUSION OR LIMITATION OF INCIDENTAL OR CONSEQUENTIAL DAMAGES. THEREFORE, THE FOREGOING EXCLUSIONS MAY NOT APPLY IN ALL CASES. This warranty provides specific legal rights. Other rights which vary from state to state may also apply.

Ordering Information

Figure B-01. Divisions of the XTend RF Modem Part Numbers

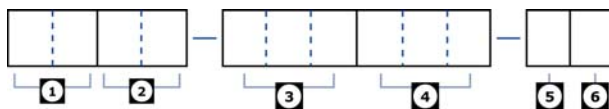

Divisions of the MaxStream PKG RF Modem part numbers:

- | | |
|--|--|
| <p>1 MaxStream Product Family
 XC = XCite
 X = XStream
 XT = XTend</p> | <p>4 Operating Temperature
 PKC = Commercial: 0 to 70° C
 PKI = Industrial: -40 to 85° C. Embedded RF Module is Conformal Coated
 PKT = Tested Industrial: -40 to 85° C. Embedded RF Module is Conformal Coated & 100% tested</p> |
| <p>2 Operating Frequency
 09 = 902-928 MHz
 24 = 2.4000 - 2.4835 GHz (XStream only)
 H9 = 923 MHz (XStream only)</p> | <p>5 Interface
 R = RS-232, RS-485/422
 U = USB
 E = Ethernet
 T = Telephone</p> |
| <p>3 Throughput Data Rate
 001 = 1200 bps (XStream only)
 009 = 9600 bps
 019 = 19200 bps (XStream only)
 038 = 38400 bps (XCite Only)
 (blank) All XTend RF Modems support 9600 & 115200 bps (software selectable)</p> | <p>6 Accessories Package
 A = Accessories Package (specific to the Interface) Included
 (blank) means the accessories package is not included</p> |

Contact MaxStream

Free and unlimited technical support is included with every MaxStream Radio Modem sold. For the best in wireless data solutions and support, please use the following resources:

Documentation:	www.maxstream.net/helpdesk/download.php	
Technical Support:	Phone.	(866) 765-9885 toll-free U.S.A. & Canada (801) 765-9885 Worldwide
	Live Chat.	www.maxstream.net
	E-Mail.	rf-xperts@maxstream.net

MaxStream office hours are 8:00 am - 5:00 pm [U.S. Mountain Standard Time]