

AMMP-6545

18 to 40 GHz GaAs MMIC Sub-Harmonic Mixer
in SMT Package

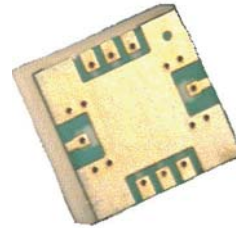

Data Sheet



Description

Avago's AMMP-6545 is an easy-to-use broadband sub-harmonic mixer, with the LO injected at half the frequency of that required by a conventional mixer. MMIC includes an 180° balanced diode based mixer. The MMIC is fabricated using PHEMT technology. The surface mount package allows elimination of "chip & wire" assembly for lower cost. This MMIC is a cost effective alternative to multi-chip solution that have higher loss and complex assembly.

Pin Connections (Top View)

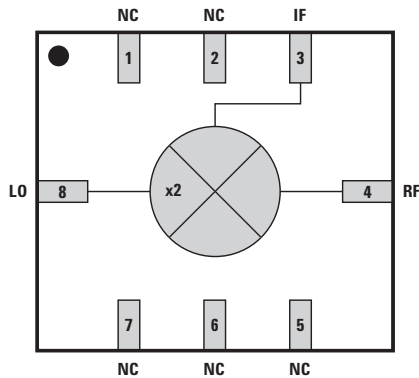

PIN	FUNCTION
1	NC
2	NC
3	IF
4	RF
5	NC
6	NC
7	NC
8	LO

TOP VIEW
PACKAGE BASE: GND



Attention: Observe precautions for handling electrostatic sensitive devices.

ESD Machine Model (30 V)

ESD Human Body Model (100 V)

Refer to Avago Technologies Application Note A004R:

Electrostatic Discharge, Damage and Control.

Features

- RF Frequency : 18-40 GHz
- LO Frequency : 9-20 GHz
- IF Frequency : DC-3.5 GHz
- 5x5 mm Surface Mount Package
- Suitable for Up and Down Conversion
- Diode Mixer

Performance

Typical 18-30 GHz

- Conversion Loss : 11 dB
- IIP3 : +11 dBm
- 2LO-R Leakage : -45 dBm
- 2LO-I Leakage : -60 dBm

Typical 30-40 GHz

- Conversion Loss : 13 dB
- IIP3 : +12 dBm
- 2LO-R Leakage : -40 dBm
- 2LO-I Leakage : -55 dBm

Applications

- Microwave radio systems
- Satellite VSAT, DBS up/down link
- LMDS & Pt-Pt mmW long haul
- Broadband wireless access (including 802.16 and 802.20 WiMax)
- WLL and MMDS loops

Absolute Maximum Ratings ^[1]

Sym.	Parameters/Condition	Unit	Max.
Pin	RF CW Input Power Max	dBm	+25
Tstg	Storage temperature	°C	-65 +150
Tmax	Maximum Assembly Temp.	°C	260 for 20s

DC Specifications/ Physical Properties ^[2]

1. Operation in excess of any of these conditions may result in permanent damage to this device.
2. Ambient operational temperature $T_A = 25^\circ\text{C}$ unless noted.

AMMP-6545 Operating Conditions

Symbol	Parameter	Units	Minimum	Typical	Maximum
RFfreq	RF Frequency	GHz	18		40
LOfreq	LO Frequency	GHz	9		20
IFfreq	IF Frequency	GHz	DC		3.5
LO	LO Power	dBm	+12	+15	+22
Tmins	Min. Ambient Operating Temp.	°C	-55		
Tmaxs	Max. Ambient Operating Temp.	°C			+125

AMMP-6545 RF Specifications

$T_A = 25^\circ\text{C}$, $Z_o = 50 \Omega$, LO = +15 dBm, IF = 2 GHz

Symbol	Parameter	Units	RF: 18-30 GHz LO: 9-15 GHz			RF: 30-40 GHz LO: 15-20 GHz		
			Min.	Typ.	Max.	Min.	Typ.	Max.
CL	Conversion Loss ^[1]	dB		11	12		13	
IIP3	Input Third Order Intercept ^[1]	dBm	10.5 9	11		12		
2LO-R	2LO-R Leakage	dBm		-45	-35		-40	
2LO-I	2LO-I Leakage	dBm		-60	-50		-55	
L-R	L-R Leakage	dB		-30			-35	
L-I	L-I Leakage	dB		-35			-30	

Note:

1. Production RF tested at 21, 23 and 26 GHz in upconverter configuration.

All tested parameters are guaranteed with the following measurement accuracy:

RF=18-24 GHz: ± 0.8 dBm for RF-leakage, ± 2.5 dBm for IF-leakage, ± 1.2 dB for Conversion Loss, ± 0.5 dBm for IIP3
 RF=24-30 GHz: ± 0.8 dBm for RF-leakage, ± 4.0 dBm for IF-leakage, ± 0.6 dB for Conversion Loss, ± 0.5 dBm for IIP3

AMMP-6545 Typical Performance

($T_A = 25^\circ\text{C}$, $Z_{in} = Z_{out} = 50 \Omega$), IF Freq = 2 GHz, LO Power = +15 dBm unless noted)

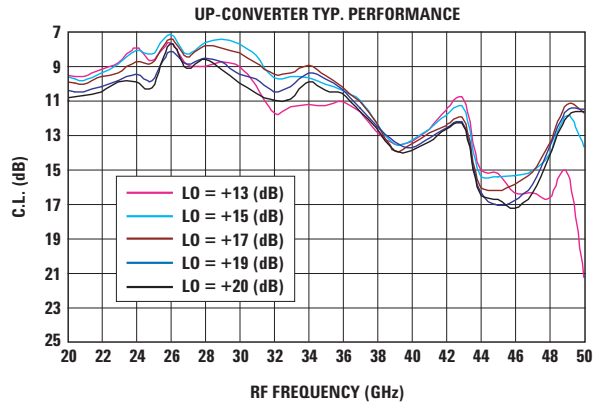

Figure 1. Up-conversion loss at LO = +13 to +20 dBm (high side LO)

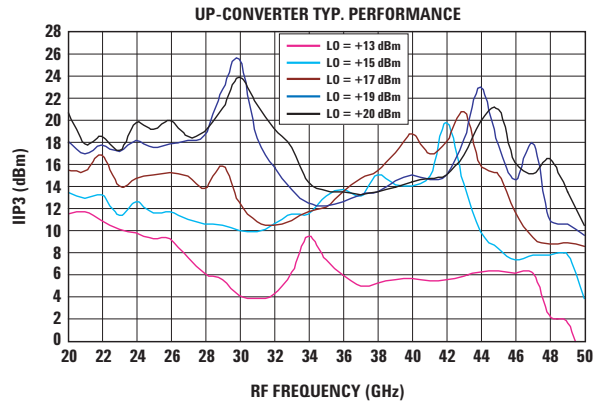

Figure 2. Up-conversion IIP3 at LO = +13 to +20 dBm (high side LO)

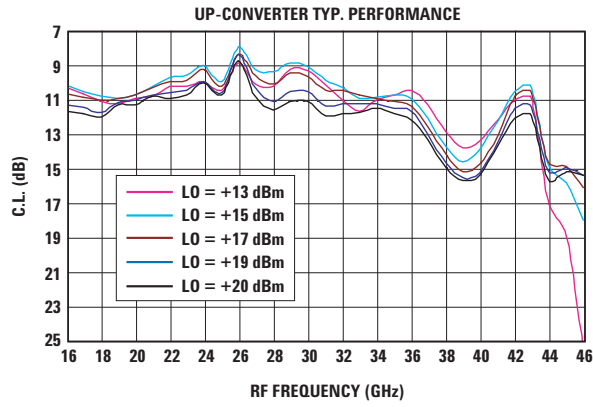

Figure 3. Up-conversion loss at LO = +13 to +20 dBm (low side LO)

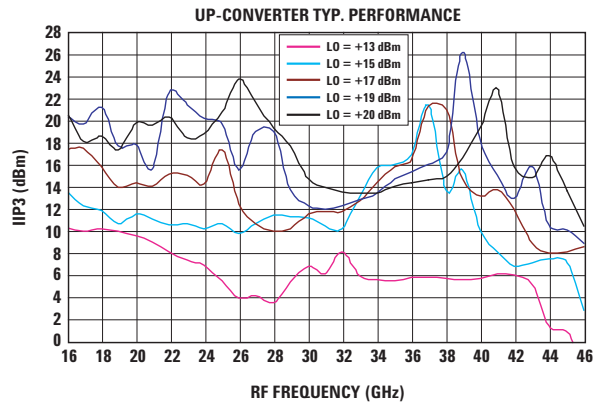

Figure 4. Up-conversion IIP3 at LO = +13 to +20 dBm (low side LO)

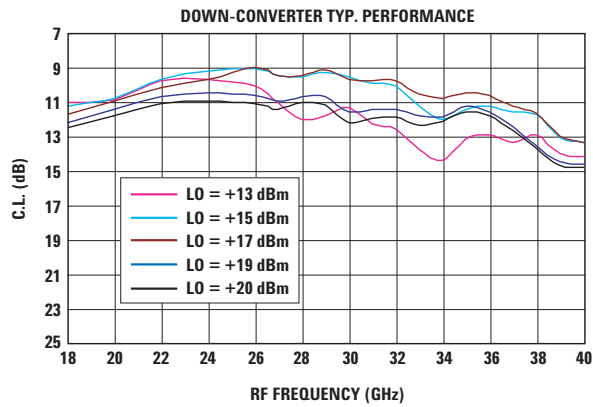

Figure 5. Down-conversion loss at LO = +13 to +20 dB (low side LO)

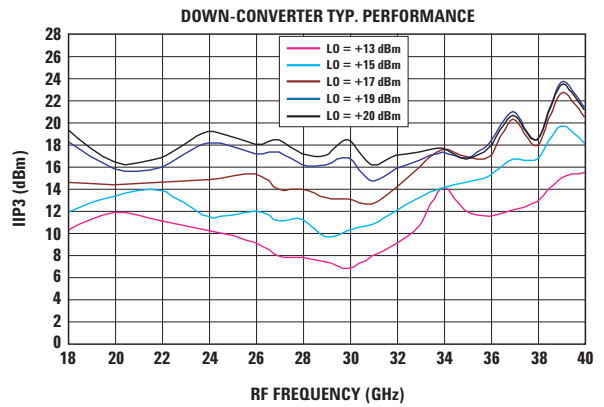

Figure 6. Down-conversion IIP3 at LO = +13 to +20 dBm (low side LO)

AMMP-6545 Typical Performance

($T_A = 25^\circ\text{C}$, $Z_{in} = Z_{out} = 50 \Omega$), IF Freq = 2 GHz, LO Power = +15 dBm unless noted)

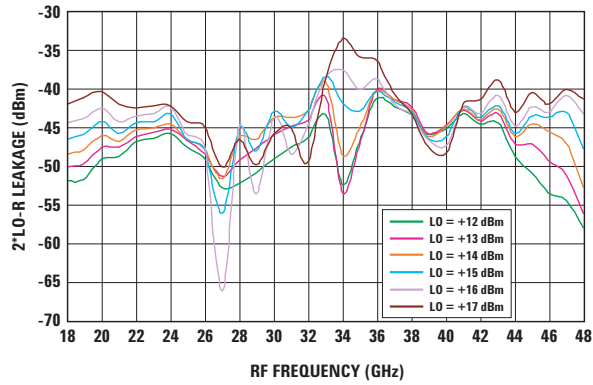

Figure 7. 2*LO-R leakage at LO = +12 to +17 dBm

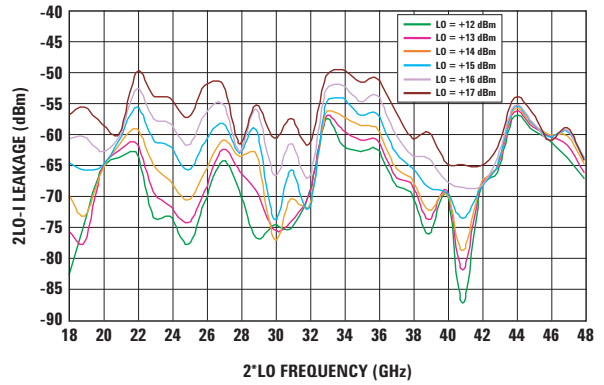

Figure 8. 2*LO-I leakage at LO = +12 to +17 dBm

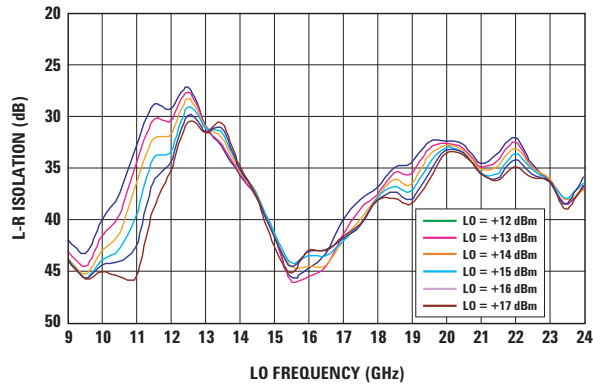

Figure 9. L-R isolation at LO = +12 to +17dBm

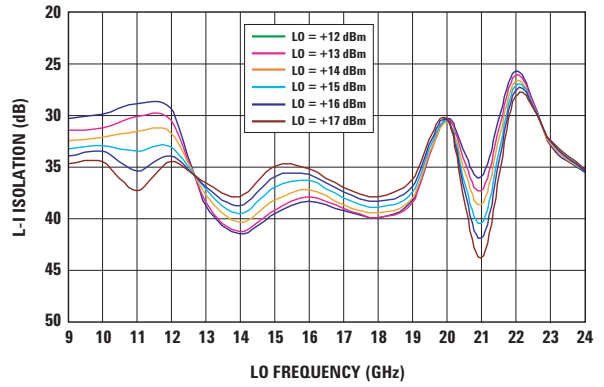

Figure 10. L-I isolation at LO = +12 to +17dBm

AMMP-6545 Application and Usage

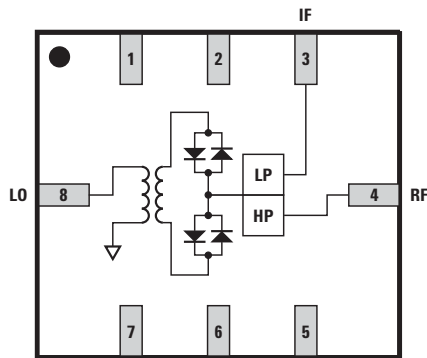

Figure 11. Simplified schematic of the mixer

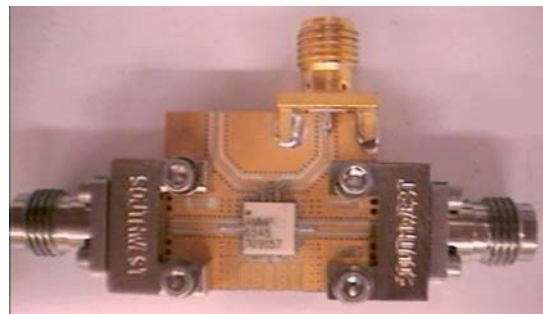

Figure 12. Photograph of test board

Recommended SMT Attachment for 5x5 Package

The AMMP Packaged Devices are compatible with high volume surface mount PCB assembly processes.

The PCB material and mounting pattern, as defined in the data sheet, optimizes RF performance and is strongly recommended. An electronic drawing of the land pattern is available upon request from Avago Sales & Application Engineering.

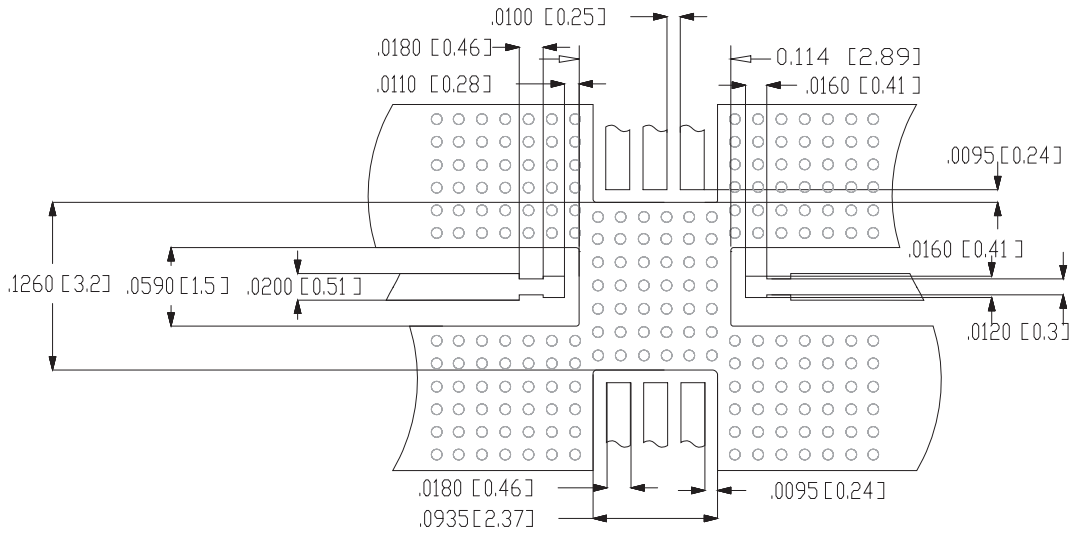

Figure 13a. PCB land pattern

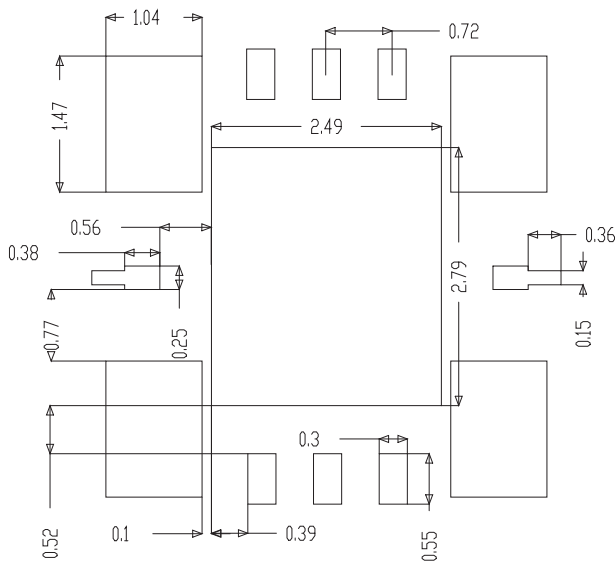

Figure 13b. PCB stencil layouts

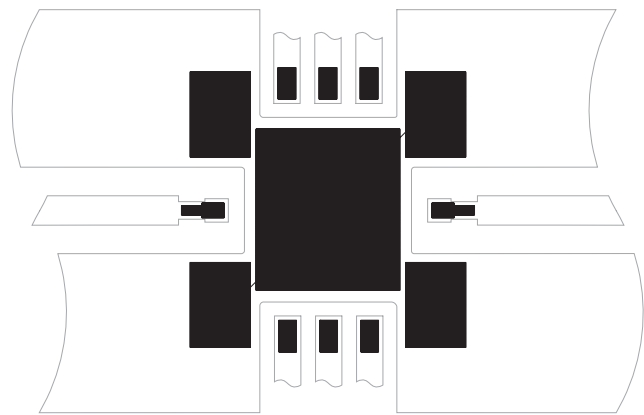

Figure 13c. PCB land pattern with stencil layouts

Manual Assembly

- Follow ESD precautions while handling packages.
- Handling should be along the edges with tweezers.
- Recommended attachment is conductive solder paste. Please see recommended solder reflow profile. Neither Conductive epoxy or hand soldering is recommended.
- Apply solder paste using a stencil printer or dot placement. The volume of solder paste will be dependent on PCB and component layout and should be controlled to ensure consistent mechanical and electrical performance.
- Follow solder paste and vendor's recommendations when developing a solder reflow profile. A standard profile will have a steady ramp up from room temperature to the pre-heat temp. to avoid damage due to thermal shock.
- Packages have been qualified to withstand a peak temperature of 260°C for 20 seconds. Verify that the profile will not expose device beyond these limits.

A properly designed solder screen or stencil is required to ensure optimum amount of solder paste is deposited onto the PCB pads. The recommended stencil layout is shown in Figure 13. The stencil has a solder paste deposition opening approximately 70% to 90% of the PCB pad. Reducing stencil opening can potentially generate more voids underneath. On the other hand, stencil openings larger than 100% will lead to excessive solder paste smear or bridging across the I/O pads. Considering the fact that solder paste thickness will directly affect the quality of the solder joint, a good choice is to use a laser cut stencil composed of 0.127 mm (5 mils) thick stainless steel which is capable of producing the required fine stencil outline.

The most commonly used solder reflow method is accomplished in a belt furnace using convection heat transfer. The suggested reflow profile for automated reflow processes is shown in Figure 14. This profile is designed to ensure reliable finished joints. However, the profile indicated in Figure 1 will vary among different solder pastes from different manufacturers and is shown here for reference only.

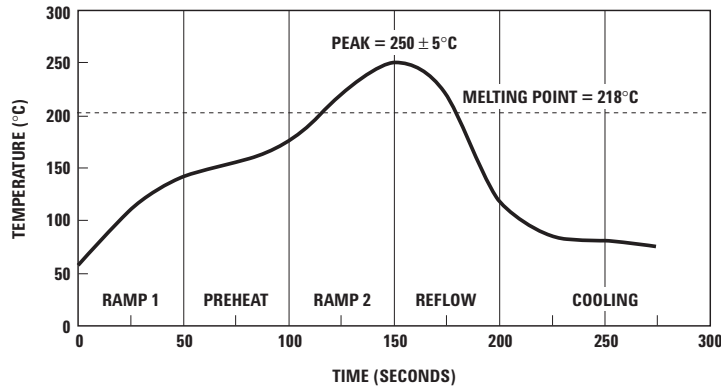
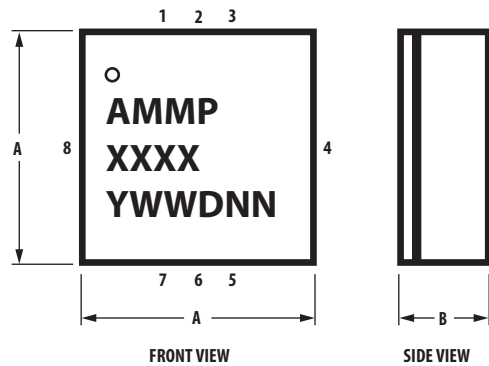

Figure 14. Suggested lead-free reflow profile for SnAgCu solder paste

AMMP-6545 Part Number Ordering Information

Part Number	Devices per Container	Container
AMMP-6545-BLKG	10	Antistatic bag
AMMP-6545-TR1G	100	7" Reel
AMMP-6545-TR2G	500	7" Reel

Package Dimensions



SYMBOL	MIN.	MAX.
A	0.198 (5.03)	0.213 (5.4)
B	0.0685 (1.74)	0.088 (2.25)

DIMENSIONS ARE IN INCHES (MM)

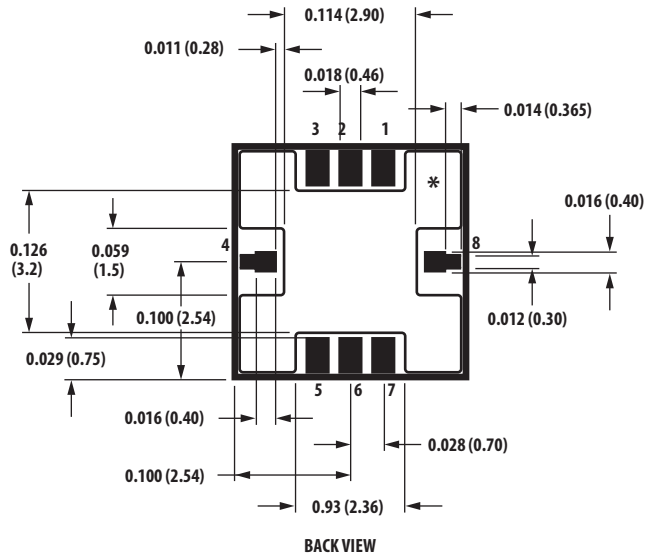

DIMENSIONAL TOLERANCE FOR BACK VIEW: 0.002" (0.05 mm)

NOTES:

- * INDICATES PIN 1
- DIMENSIONS ARE IN INCHES (MILLIMETERS)
- ALL GROUNDS MUST BE SOLDERED TO PCB RF GROUND

Tape Dimensions

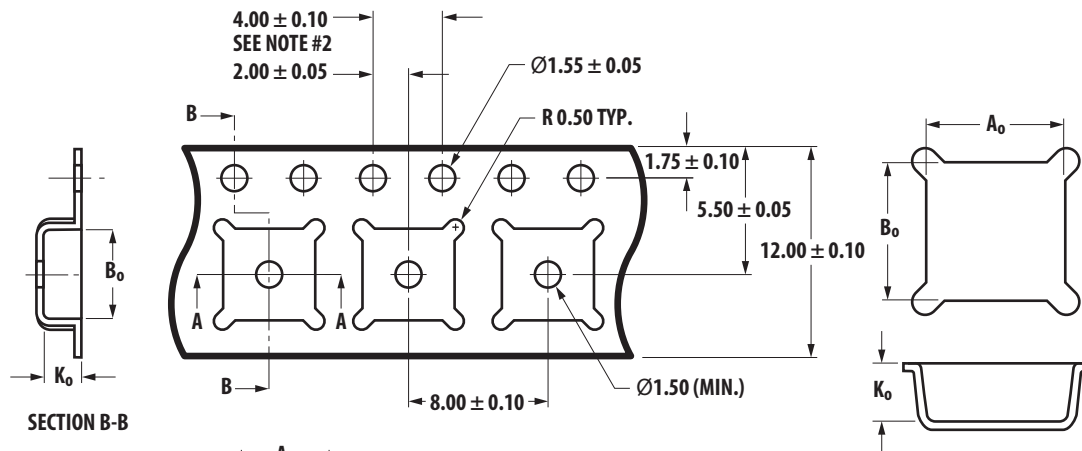

SECTION B-B

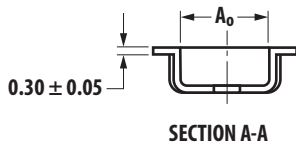

SECTION A-A

A ₀ :	5.30				
B ₀ :	5.30				
K ₀ :	2.20				
PITCH:	8.00				
WIDTH:	12.00				
		A ₀	B ₀	K ₀	
		MIN.	5.20	5.20	2.10
		NOM.	5.30	5.30	2.20
		MAX.	5.40	5.40	2.30

Notes:

- A₀ and B₀ measured at 0.3 Mm above base of pocket.
- 10 Pitches cumulative tolerance is ± 0.2 Mm.
- Dimensions are in millimeters (mm).

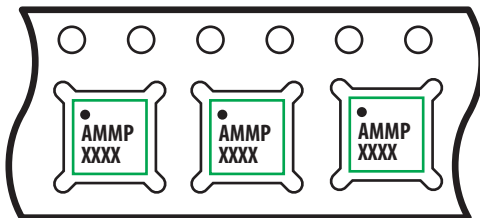

For product information and a complete list of distributors, please go to our website: www.avagotech.com

Avago, Avago Technologies, and the A logo are trademarks of Avago Technologies in the United States and other countries. Data subject to change. Copyright © 2005-2010 Avago Technologies. All rights reserved. Obsoletes AV02-0251EN AV02-1382EN - January 20, 2010

AVAGO
TECHNOLOGIES