

DATA SHEET

SKY73070: 700 – 1000 MHz High Gain and Linearity Single Downconversion Mixer

Applications

- 2G/3G base station transceivers:
 - GSM/EDGE, CDMA, UMTS/WCDMA, iDEN
- Land mobile radio
- ISM band transceivers
- High performance radio links
- RF identification

Features

- Operating frequency range: 700 to 1000 MHz
- IF frequency range: 40 to 300 MHz
- Conversion gain: 9.5 dB
- Input IP3: +27.0 dBm
- Output IP3: +36.5 dBm
- Noise figure: 8.3 dB
- Integrated LO driver
- Integrated low loss RF balun
- High linearity IF amplifier
- Small, MCM (20-pin, 5 x 5 mm) Pb-free package (MSL3, 260 °C per JEDEC J-STD-020)

NEW Skyworks offers lead (Pb)-free RoHS (Restriction of Hazardous Substances) compliant packaging.



Description

The SKY73070 is a fully integrated single mixer that includes a Local Oscillator (LO) driver, high linearity mixer, and large dynamic range Intermediate Frequency (IF) amplifier. A low loss RF balun has also been included to reduce design complications and lower system cost.

The SKY73070 features an input IP3 of +27.0 dBm and a Noise Figure (NF) of 8.3 dB, making the device an ideal solution for high dynamic range systems such as 2G/3G base station transceivers.

The SKY73070 is manufactured using a robust silicon BiCMOS process and has been designed for optimum long-term reliability. The SKY73070 single downconversion mixer is provided in a compact, 20-pin 5 x 5 mm Multi-Chip Module (MCM). A functional block diagram is shown in Figure 1. The pin configuration and package are shown in Figure 2. Signal pin assignments and functional pin descriptions are provided in Table 1.

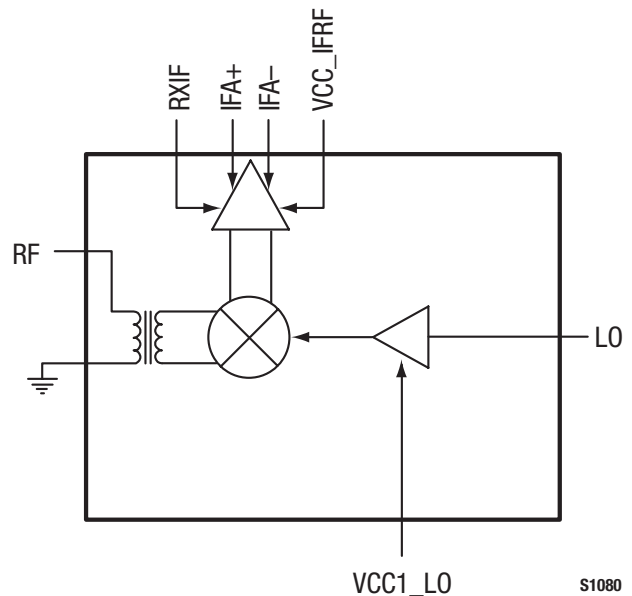
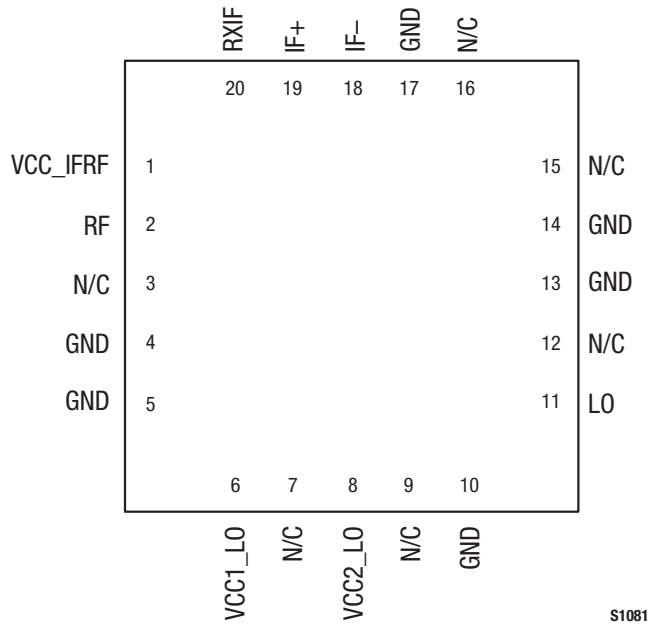

Figure 1. SKY73070 Block Diagram



S1081

Figure 2. SKY73070 Pinout – 20-Pin MCM

Table 1. SKY73070 Signal Descriptions

Pin #	Name	Description	Pin #	Name	Description
1	VCC_IFRF	IF and RF DC supply, +5V	11	LO	LO input
2	RF	RF input	12	N/C	No connection
3	N/C	No connection	13	GND	Ground
4	GND	Ground	14	GND	Ground
5	GND	Ground	15	N/C	No connection
6	VCC1_LO	DC supply for LO driver, +5V	16	N/C	No connection
7	N/C	No connection	17	GND	Ground
8	VCC2_LO	DC supply for LO buffer, +5V	18	IF-	Negative IF output
9	N/C	No connection	19	IF+	Positive IF output
10	GND	Ground	20	RXIF	IF bias adjust

Functional Description

The SKY73070 is a high gain single mixer, optimized for base station receiver applications. The device consists of a low loss RF balun, high linearity passive mixer, and a low noise IF amplifier.

An LO amplifier is also included that allow the SKY73070 to connect directly to the output of a Voltage Controlled Oscillator (VCO). This eliminates the extra gain stages needed by most discrete passive mixers.

RF Balun and Passive Mixer

The RF balun provides a single ended input, which can easily be matched to 50 Ω using a simple external matching circuit. The RF balun offers very low loss, and excellent amplitude and phase balance.

The high linearity SKY73070 is a passive, double balanced mixer that provides a very low conversion loss, and excellent 3rd Order Input Insertion Point (IIP3).

Additionally, the balanced nature of the mixer provides for high port-to-port isolation.

LO Buffer

An LO buffer allows the input power of the SKY73070 to be in the range of ± 6 dBm. The LO section is optimized for high-side LO

injection. However, the LO can be driven over a wide frequency range with only slight degradation in performance.

IF Amplifier

The SKY73070 includes a high dynamic range IF amplifier that follows the passive mixer in the signal path. The outputs require a supply voltage connection using inductive chokes. These choke inductors should be high-Q and have the ability to handle 200 mA or greater.

A simple matching network allows the output ports to be matched to a balanced 200 Ω impedance. The IF amplifier is optimized for IF frequencies between 40 and 300 MHz. The IF amplifier can be operated outside of this range, but with a slight degradation in performance.

Electrical and Mechanical Specifications

The absolute maximum ratings of the SKY73070 are provided in Table 2 and the recommended operating conditions in Table 3. Electrical characteristics for the SKY73070 are provided in Table 4.

Typical performance characteristics for the SKY73070 are illustrated in Figures 3 through 18.

Table 2. SKY73070 Absolute Maximum Ratings (Note 1)

Parameter	Symbol	Minimum	Maximum	Units
Supply voltage, +5 V	VCC	4.5	5.5	V
Supply current	I _{CC}		240	mA
RF input power	P _{RF}		+20.0	dBm
LO input power	P _{LO}		+20.0	dBm
Operating case temperature	T _C	-40	+85	°C
Junction temperature (Note 2)	T _J		+150	°C
Storage case temperature	T _{STG}	-40	+125	°C

Note 1: Exposure to maximum rating conditions for extended periods may reduce device reliability. There is no damage to device with only one parameter set at the limit and all other parameters set at or below their nominal value.

Note 2: Nominal thermal resistance (junction to center ground pad) is 5.1 °C/W.

Table 3. SKY73070 Recommended Operating Conditions

Parameter	Symbol	Minimum	Typical	Maximum	Units
Supply voltage, +5 V	VCC	4.75	5.00	5.25	V
Supply current	I _{CC}		210		mA
LO input power	P _{LO}	-6.0	0	+6.0	dBm
Operating case temperature	T _C	-40		+85	°C
RF frequency range	f _{RF}	700		1000	MHz
LO frequency range (Note 1)	F _{LO}	900		1250	MHz
IF frequency range	F _{IF}	40		300	MHz

Note 1: The SKY73070 has been optimized for high-side LO injection. However, the LO can be used outside of the specified frequency range with degraded performance.

Table 4. SKY73070 Electrical Specifications

(VCC = +5 V, T_A = +25 °C, LO = 0 dBm, RF Frequency = 900 MHz, IF Frequency = 200 MHz, LO Frequency = 1100 MHz, Unless Otherwise Noted)

Parameter	Symbol	Test Condition	Min	Typical	Max	Units
Conversion gain	G	f _{RF} = 824 to 915 MHz, T _A = 25 °C, P _{LO} = -3 to +3 dBm	8.2	9.5		dB
Gain variation over temperature		T _A = -40 to +85 °C		±0.6		dB
Noise Figure	NF	T _A = 25 °C, P _{LO} = -3 to +3 dBm, VCC = 4.75 to 5.25 V, IF = 200 MHz		8.3		dB
Noise Figure variation over temperature		T _A = -40 to +85 °C		±0.8		dB
Noise Figure with a blocker signal	NF _{BLK}	Blocking signal input power = +8 dBm		18		dB
Third order input intercept point	IIP3	f _{RF} = 900 MHz and 900.8 MHz, P _{RF} = -10 dBm/tone, VCC = 4.75 to 5.25 V	+24.7	+27.0		dBm
Input IP3 variation over temperature		T _A = -40 to +85 °C		±0.3		dB
Third order output intercept point	OIP3	f _{RF} = 900 MHz and 900.8 MHz, P _{RF} = -10 dBm/tone, VCC = 4.75 to 5.25 V		+36.5		dBm
2RF – 2LO	2x2	P _{RF} = -10 dBm		-68.5	-63	dBc
3RF – 3LO	3x3	P _{RF} = -10 dBm		-80	-70	dBc
Input 1 dB compression point	IP1dB		+11.0	+13.3		dBm
Output 1 dB compression point	OP1dB			+22.8		dBm
RF to IF isolation			30	48		dB
LO leakage: @ RF port @ IF port				-59 -34	-20 -23	dBm dBm
RF port input return loss	Z _{IN_RF}	With external matching components	14			dB
LO port input return loss	Z _{IN_LO}	With external matching components	14			dB
IF port output return loss	Z _{OUT_IF}	With external matching components	14			dB

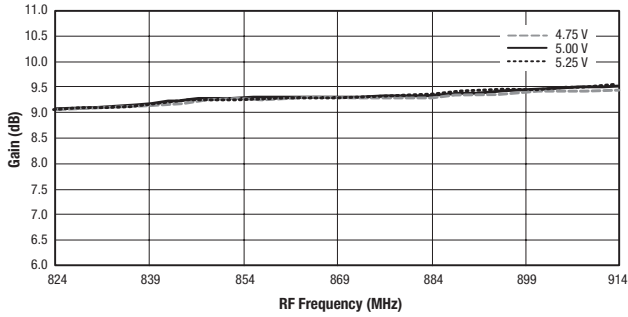

Figure 3. Gain vs Frequency and Supply Voltage

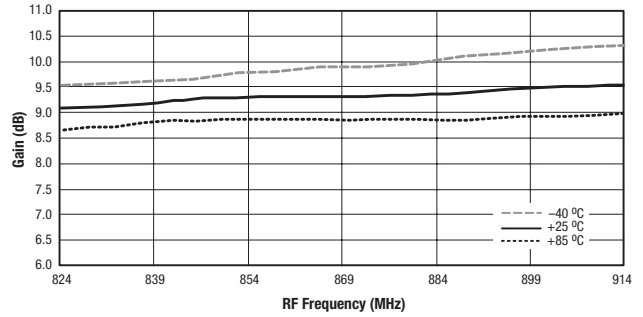

Figure 4. Gain vs Frequency and Temperature

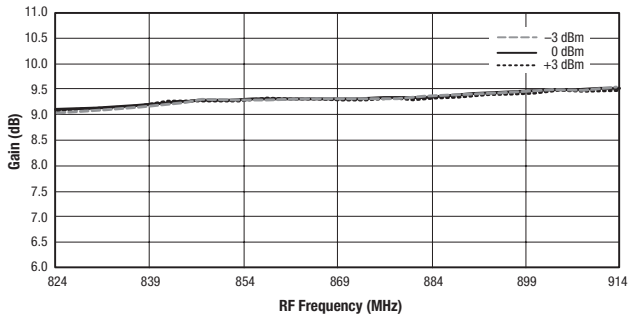

Figure 5. Gain vs Frequency and LO Power

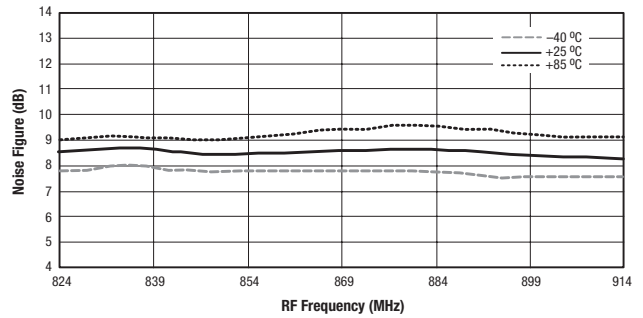

Figure 6. Noise Figure vs Frequency and Temperature

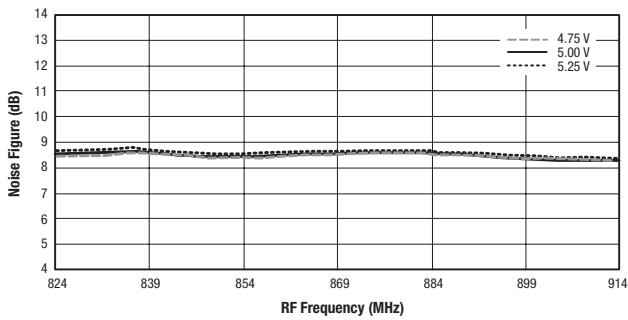

Figure 7. Noise Figure vs Frequency and Supply Voltage

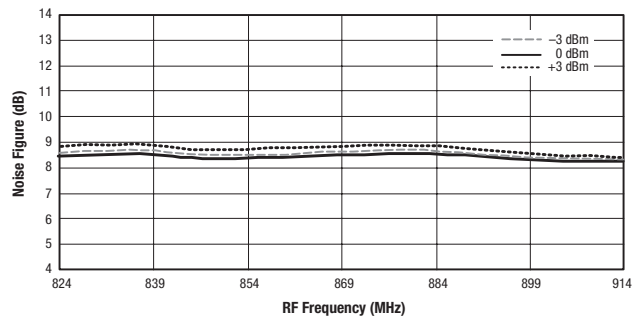

Figure 8. Noise Figure vs Frequency and LO Power

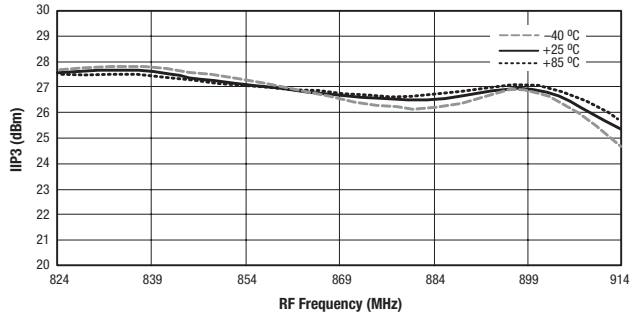

Figure 9. IIP3 vs Frequency and Temperature

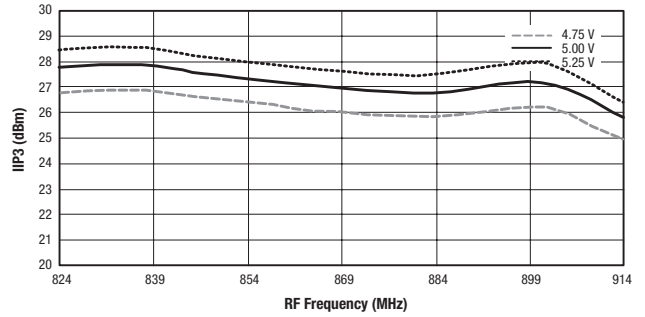

Figure 10. IIP3 vs Frequency and Supply Voltage

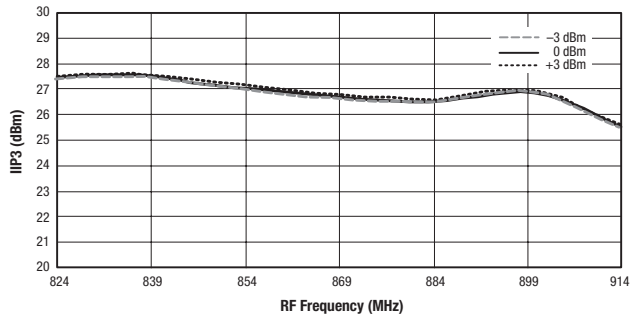

Figure 11. IIP3 vs Frequency and LO Power

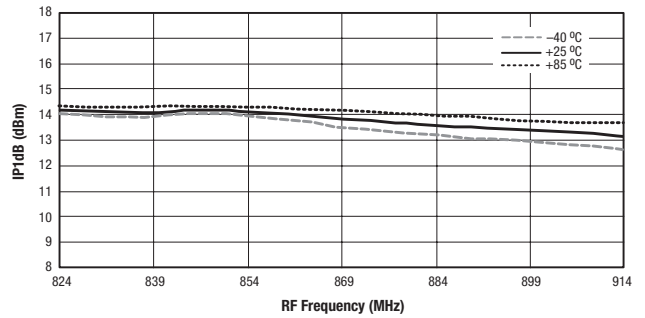

Figure 12. IP1dB vs Frequency and Temperature

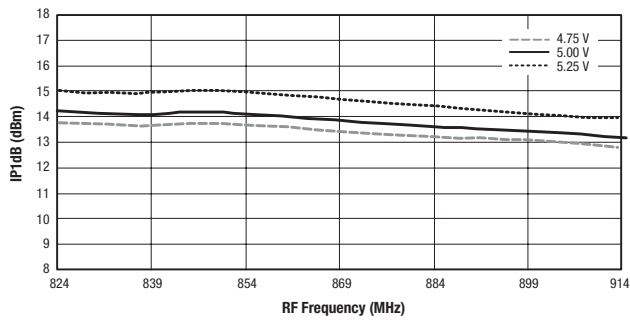

Figure 13. IP1dB vs Frequency and Supply Voltage

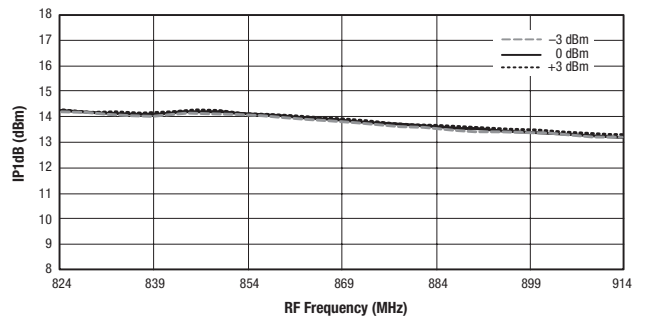

Figure 14. IP1dB vs Frequency and LO Power

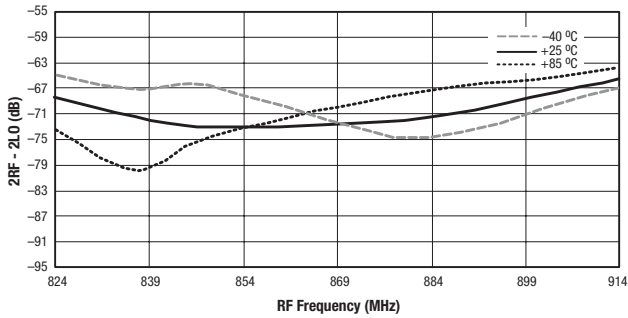

Figure 15. 2RF – 2LO vs Frequency and Temperature

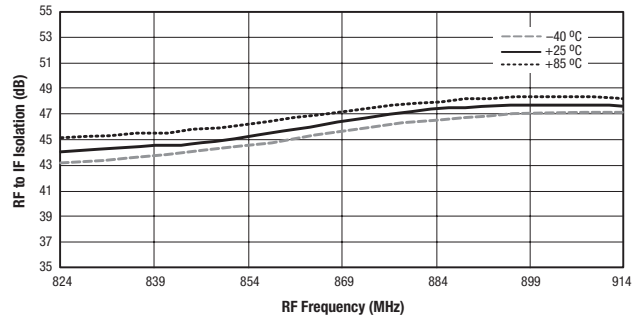

Figure 16. RF to IF Isolation vs Frequency and Temperature

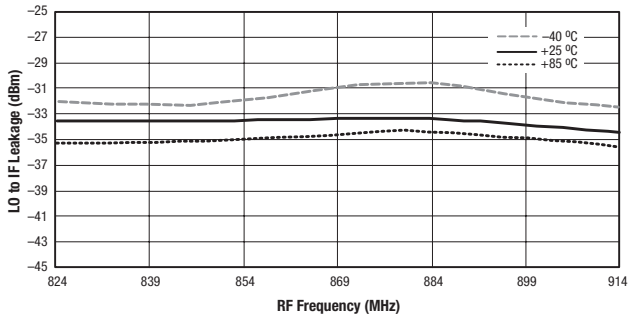

Figure 17. LO to IF Leakage vs Frequency and Temperature

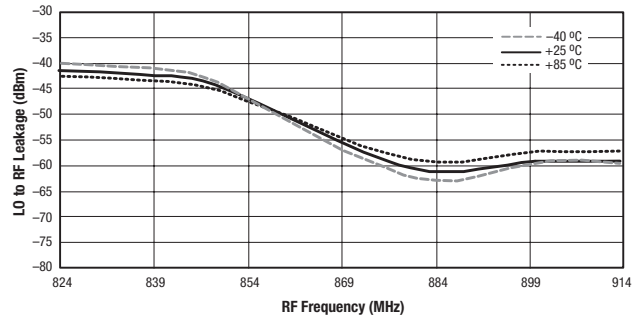

Figure 18. LO to RF Leakage vs Frequency and Temperature

Evaluation Board Description

The SKY73070 Evaluation Board is used to test the performance of the SKY73070 downconversion mixer. An assembly drawing for the Evaluation Board is shown in Figure 19 and the layer detail is provided in Figure 20.

Circuit Design Configurations

The following design considerations are general in nature and must be followed regardless of final use or configuration:

1. Paths to ground should be made as short and as low impedance as possible.
2. The ground pad of the SKY73070 provides critical electrical and thermal functionality. This pad is the main thermal conduit for heat dissipation. Since the circuit board acts as the heat sink, it must shunt as much heat as possible from the device. Therefore, design the connection to the ground pad to dissipate the maximum heat produced by the circuit board. For more information on soldering the SKY73070, refer

to the Package and Handling Information section of this Data Sheet.

3. Skyworks recommends including external bypass capacitors on the VCC voltage inputs of the device.
4. Components L5 and L4 (see Figure 21) are high-Q, low loss inductors. These inductors must be able to pass currents in excess of 200 mA DC.
5. Components R7 and R8 (see Figure 21) allow for external adjustment of the IF amplifier bias points. To reduce the IF amplifier bias current, connect pin 20 to ground through external resistor R8. To increase the IF amplifier bias current, connect pin 20 to VCC through external resistor R7. For operation as specified in Tables 3 and 4, these resistors are not required.

A schematic diagram for the SKY73070 Evaluation Board is shown in Figure 21.

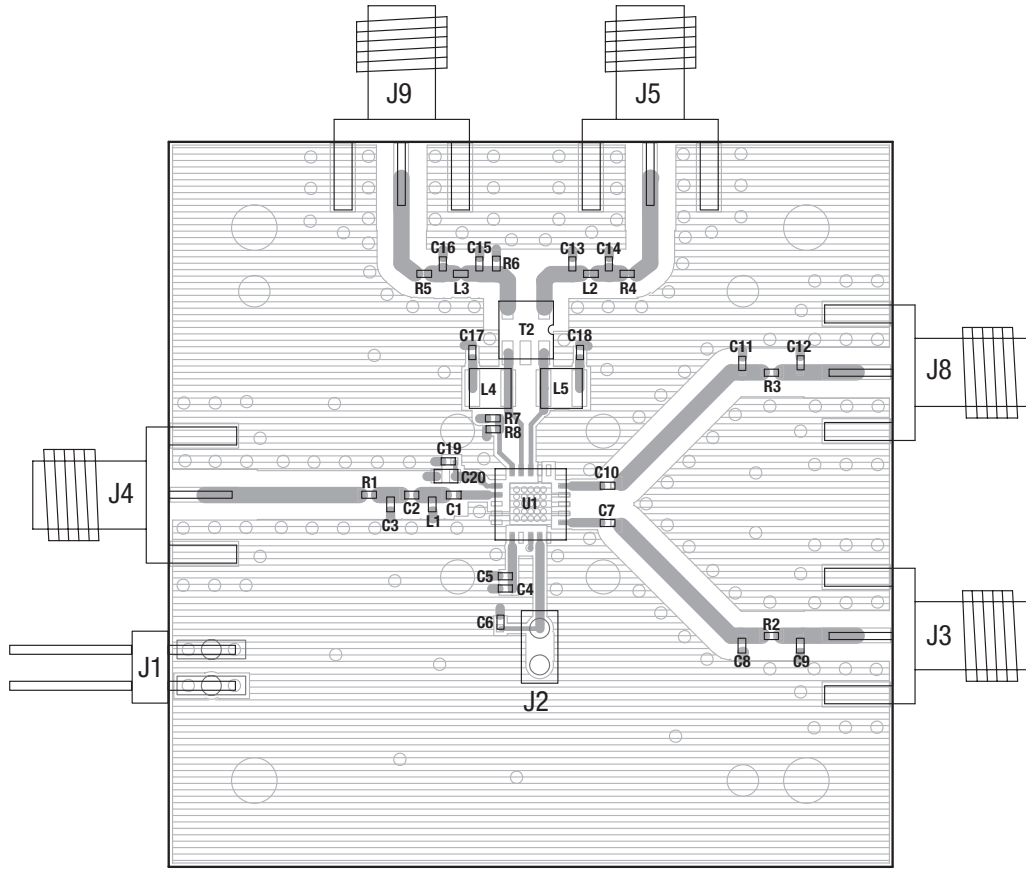

Note: This Evaluation Board is used for several different Skyworks devices.
 Components C4, C6, C8 through C13, C15 through C19, R3, R5, and L3 are not used for the device described by this Data Sheet.

S1083

Figure 19. SKY73070 Evaluation Board Assembly Diagram

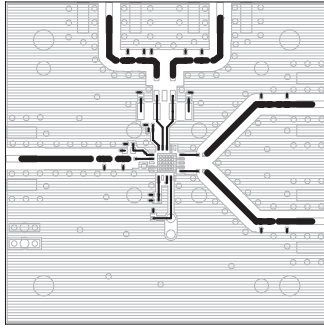

Layer 1: Top – Metal

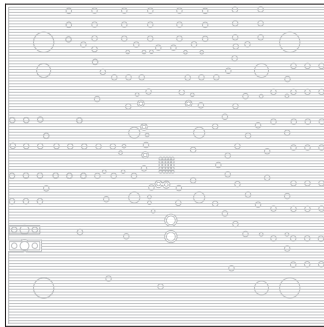

Layer 2: Ground

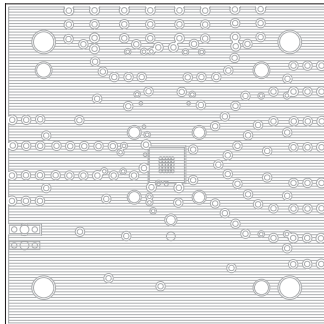

Layer 3: Power Plane

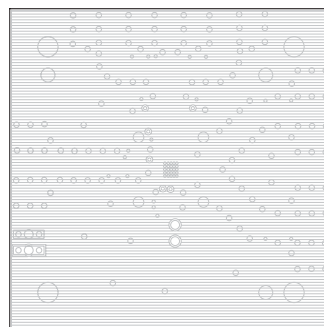

Layer 4: Solid Ground Plane

S940

Figure 20. SKY73070 Evaluation Board Layer Detail

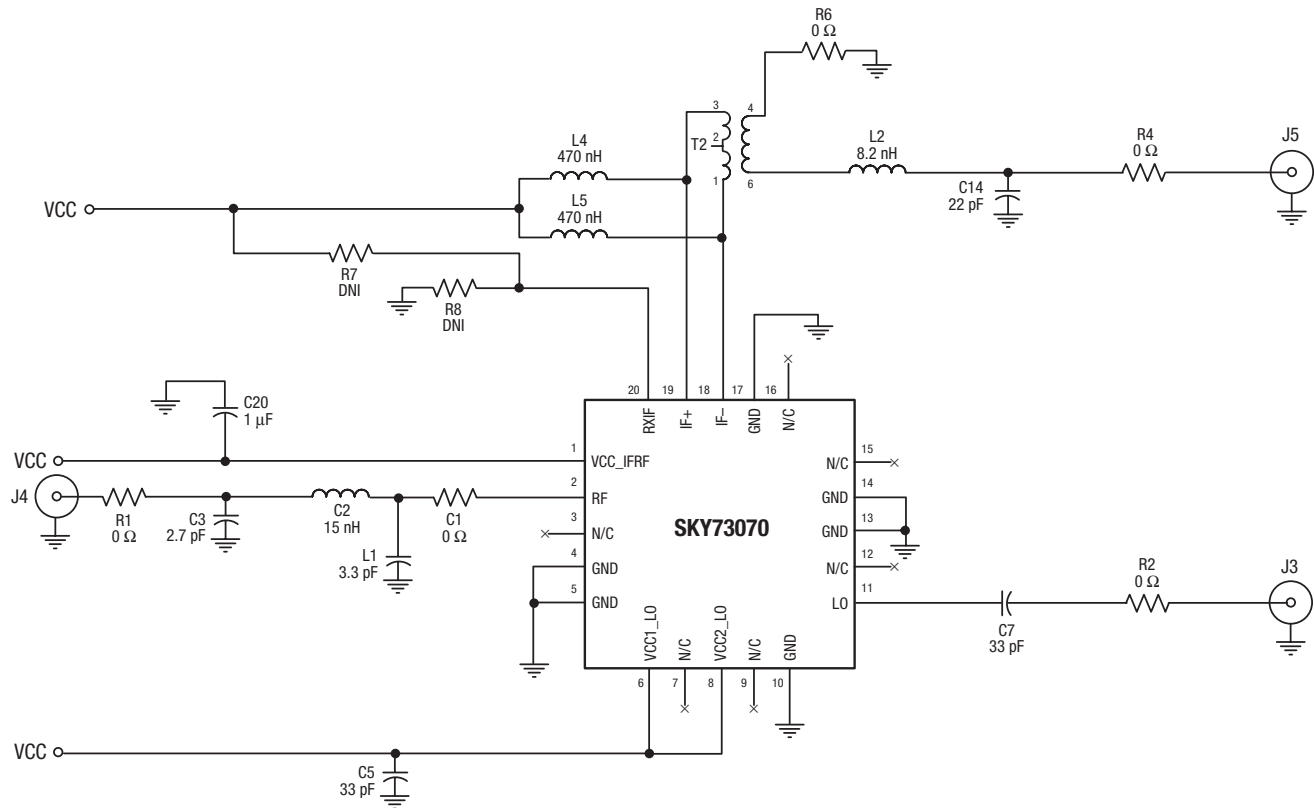

Notes: Values for all components are subject to change for matching purposes.

Some component labels may be different than the corresponding component symbol shown here. Component values, however, are accurate as of the date of this Data Sheet.

S1082

Figure 21. SKY73070 Evaluation Board Schematic

Package Dimensions

Figure 22 shows the package dimensions for the 20-pin MCM, and Figure 23 provides the tape and reel dimensions.

Package and Handling Information

Since the device package is sensitive to moisture absorption, it is baked and vacuum packed before shipping. Instructions on the shipping container label regarding exposure to moisture after the container seal is broken must be followed. Otherwise, problems related to moisture absorption may occur when the part is subjected to high temperature during solder assembly.

THE SKY73070 is rated to Moisture Sensitivity Level 3 (MSL3) at 260 °C. It can be used for lead or lead-free soldering. For additional information, refer to the Skyworks Application Note,

PCB Design & SMT Assembly/Rework Guidelines for MCM-L Packages, document number 101752.

Care must be taken when attaching this product, whether it is done manually or in a production solder reflow environment. Production quantities of this product are shipped in a standard tape and reel format. For packaging details, refer to the Skyworks Application Note, *Tape and Reel*, document number 101568.

Electrostatic Discharge (ESD) Sensitivity

The SKY73070 is a static-sensitive electronic device. Do not operate or store near strong electrostatic fields. Take proper ESD precautions.

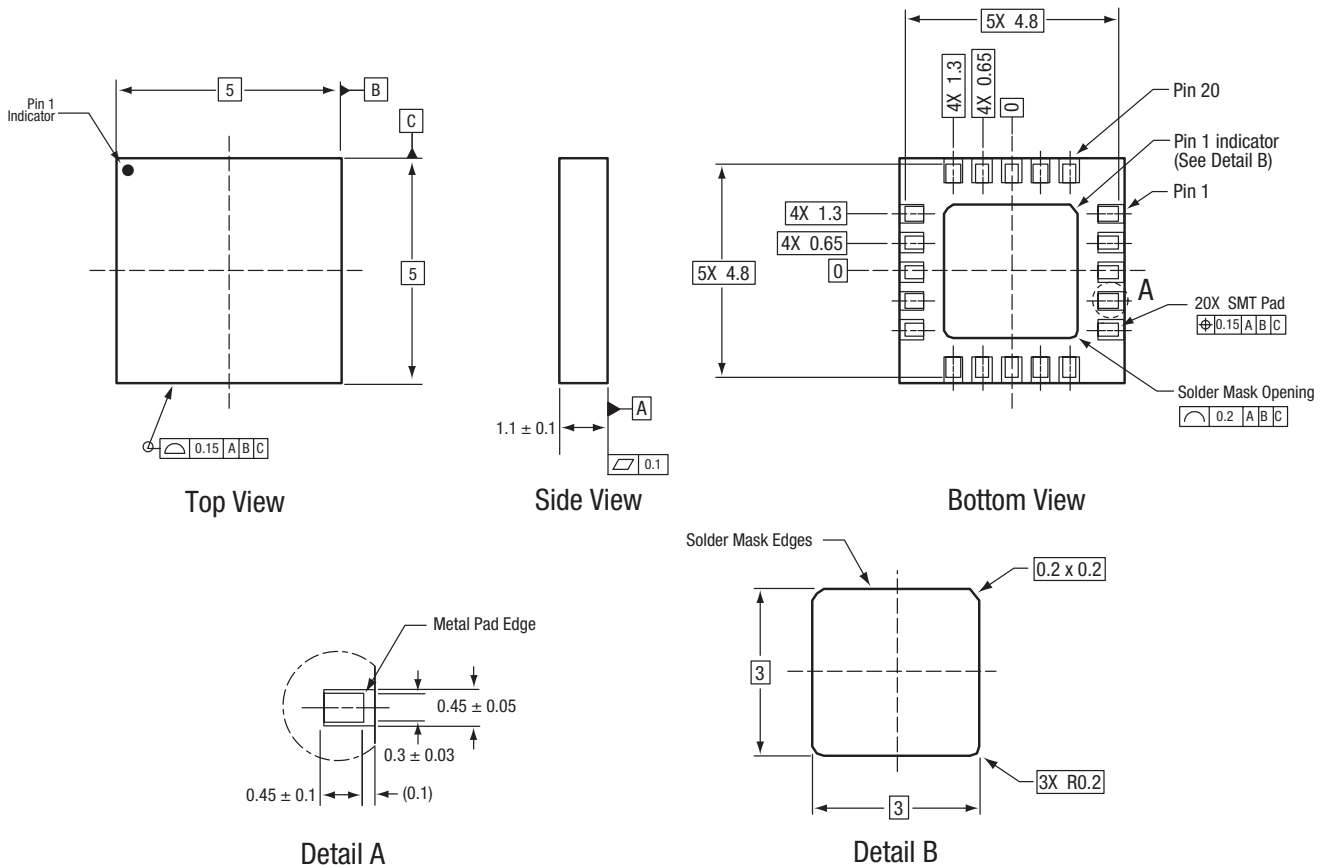

All measurements are in millimeters.
Dimensioning and tolerancing according to ASME Y14.5M-1994.

S944

Figure 22. SKY73070 20-Pin MCM Package Dimensions

Ordering Information

Model Name	Manufacturing Part Number	Evaluation Kit Part Number
SKY73070 700-1000 MHz Downconversion Mixer	SKY73070-11 (Pb-free package)	TW16-D660

Copyright © 2007, 2008 Skyworks Solutions, Inc. All Rights Reserved.

Information in this document is provided in connection with Skyworks Solutions, Inc. ("Skyworks") products or services. These materials, including the information contained herein, are provided by Skyworks as a service to its customers and may be used for informational purposes only by the customer. Skyworks assumes no responsibility for errors or omissions in these materials or the information contained herein. Skyworks may change its documentation, products, services, specifications or product descriptions at any time, without notice. Skyworks makes no commitment to update the materials or information and shall have no responsibility whatsoever for conflicts, incompatibilities, or other difficulties arising from any future changes.

No license, whether express, implied, by estoppel or otherwise, is granted to any intellectual property rights by this document. Skyworks assumes no liability for any materials, products or information provided hereunder, including the sale, distribution, reproduction or use of Skyworks products, information or materials, except as may be provided in Skyworks Terms and Conditions of Sale.

THE MATERIALS, PRODUCTS AND INFORMATION ARE PROVIDED "AS IS" WITHOUT WARRANTY OF ANY KIND, WHETHER EXPRESS, IMPLIED, STATUTORY, OR OTHERWISE, INCLUDING FITNESS FOR A PARTICULAR PURPOSE OR USE, MERCHANTABILITY, PERFORMANCE, QUALITY OR NON-INFRINGEMENT OF ANY INTELLECTUAL PROPERTY RIGHT; ALL SUCH WARRANTIES ARE HEREBY EXPRESSLY DISCLAIMED. SKYWORKS DOES NOT WARRANT THE ACCURACY OR COMPLETENESS OF THE INFORMATION, TEXT, GRAPHICS OR OTHER ITEMS CONTAINED WITHIN THESE MATERIALS. SKYWORKS SHALL NOT BE LIABLE FOR ANY DAMAGES, INCLUDING BUT NOT LIMITED TO ANY SPECIAL, INDIRECT, INCIDENTAL, STATUTORY, OR CONSEQUENTIAL DAMAGES, INCLUDING WITHOUT LIMITATION, LOST REVENUES OR LOST PROFITS THAT MAY RESULT FROM THE USE OF THE MATERIALS OR INFORMATION, WHETHER OR NOT THE RECIPIENT OF MATERIALS HAS BEEN ADVISED OF THE POSSIBILITY OF SUCH DAMAGE.

Skyworks products are not intended for use in medical, lifesaving or life-sustaining applications, or other equipment in which the failure of the Skyworks products could lead to personal injury, death, physical or environmental damage. Skyworks customers using or selling Skyworks products for use in such applications do so at their own risk and agree to fully indemnify Skyworks for any damages resulting from such improper use or sale.

Customers are responsible for their products and applications using Skyworks products, which may deviate from published specifications as a result of design defects, errors, or operation of products outside of published parameters or design specifications. Customers should include design and operating safeguards to minimize these and other risks. Skyworks assumes no liability for applications assistance, customer product design, or damage to any equipment resulting from the use of Skyworks products outside of stated published specifications or parameters.

Skyworks, the Skyworks symbol, and "Breakthrough Simplicity" are trademarks or registered trademarks of Skyworks Solutions, Inc., in the United States and other countries. Third-party brands and names are for identification purposes only, and are the property of their respective owners. Additional information, including relevant terms and conditions, posted at www.skyworksinc.com, are incorporated by reference.