



# 700MHz to 1200MHz High-Linearity, SPI-Controlled DVGA with Integrated Loopback Mixer

MAX2058

## General Description

The MAX2058 high-linearity digital-variable-gain amplifier (DVGA) is designed to provide 62dB of total gain range and typical output IP3 and output P1dB levels of +32.3dBm and +19dBm, respectively. The device is ideal for a variety of applications, including RFID handheld and portal readers, as well as single and multicarrier 700MHz to 1200MHz GSM/EDGE, cdma2000®, WCDMA, and iDEN® base stations. The MAX2058 yields a high level of component integration, which includes two 5-bit, 31dB digital attenuators, a two-stage driver amplifier, a loopback mixer, and a serial interface to control the attenuators.

The MAX2058 is pin compatible with the MAX2059 1800MHz to 2200MHz DVGA, facilitating an easy design-in for applications where a common PC board layout is used for both frequency bands.

The MAX2058 is available in a 40-pin thin QFN package with an exposed paddle. Electrical performance is guaranteed over a -40°C to +85°C temperature range.

## Applications

GSM 850/GSM 900 2G and 2.5G EDGE Base-Station Transmitters and Power Amplifiers

Cellular cdmaOne™, cdma2000, and Integrated Digital Enhanced Network (iDEN) Base-Station Transmitters and Power Amplifiers

WCDMA 850MHz and Other 3G Base-Station Transmitters and Power Amplifiers

Transmitter Gain Control

Receiver Gain Control

Broadband Systems

Automatic Test Equipment

Digital and Spread-Spectrum Communication Systems

Microwave Terrestrial Links

RFID Handheld and Portal Readers

*SPI is a trademark of Motorola, Inc.*

*MICROWIRE is a trademark of National Semiconductor Corp.*

*cdma2000 is a registered trademark of Telecommunications Industry Association.*

*iDEN is a registered trademark of Motorola, Inc.*

*cdmaOne is a trademark of CDMA Development Group.*

## Features

- ◆ +32.3dBm Typical Output IP3
- ◆ +19dBm Typical Output 1dB Compression Point
- ◆ 700MHz to 1200MHz RF Frequency Range
- ◆ 1800MHz to 2200MHz RF Frequency Range (MAX2059)
- ◆ 10.5dB Typical Small-Signal Gain
- ◆ Includes Two Independent 31dB Attenuator Stages, Yielding 62dB of Total Gain-Control Range with 1dB Steps
- ◆ 3-Wire SPI™/MICROWIRE™-Compatible
- ◆ Integrated Loopback Mixer for Tx/Rx Self-Diagnostics
- ◆ +5V Single-Supply Operation
- ◆ External Current-Setting Resistors for Scalable Device Power
- ◆ Lead-Free Package Available

## Ordering Information

PART	TEMP RANGE	PIN-PACKAGE	PKG CODE
MAX2058ETL	-40°C to +85°C	40 Thin QFN-EP** (6mm x 6mm)	T4066-3
MAX2058ETL-T	-40°C to +85°C	40 Thin QFN-EP** (6mm x 6mm)	T4066-3
MAX2058ETL+	-40°C to +85°C	40 Thin QFN-EP** (6mm x 6mm)	T4066-3
MAX2058ETL+T	-40°C to +85°C	40 Thin QFN-EP** (6mm x 6mm)	T4066-3

\*\*EP = Exposed paddle.

+ Denotes lead-free package.

T = Tape-and-reel.

**Pin Configuration/Functional Diagram appears at end of data sheet.**



# 700MHz to 1200MHz High-Linearity, SPI-Controlled DVGA with Integrated Loopback Mixer

## ABSOLUTE MAXIMUM RATINGS

V <sub>CC</sub> to GND	-0.3V to +5.5V
RSET1, RSET2	+1.2V to +4.0V
LBBIAS	(V <sub>CC</sub> - 1.5V) to +5.5V
LB_EN, DATA, CS, CLK	-0.3V to (V <sub>CC</sub> + 0.3V)
ATTEN_INA, ATTEN_INB, ATTEN_OUTA, ATTEN_OUTB	
Input Power	+24dBm
AMPIN, Differential LO Input Power	+12dBm
Continuous Power Dissipation (T <sub>A</sub> = +70°C)	
40-Pin TQFN (derated 26.3mW/°C above +70°C)	2100mW

Operating Temperature Range (Note A)	-40°C to +85°C
Junction Temperature	+150°C
θ <sub>JC</sub>	10°C/W
θ <sub>JA</sub>	38°C/W
Storage Temperature Range	-65°C to +150°C
Lead Temperature (soldering, 10s)	+300°C

**Note A:** T<sub>C</sub> is the temperature on the exposed paddle of the package.

Stresses beyond those listed under "Absolute Maximum Ratings" may cause permanent damage to the device. These are stress ratings only, and functional operation of the device at these or any other conditions beyond those indicated in the operational sections of the specifications is not implied. Exposure to absolute maximum rating conditions for extended periods may affect device reliability.

## DC ELECTRICAL CHARACTERISTICS

(MAX2058 Typical Application Circuit, V<sub>CC</sub> = +4.75V to +5.25V, R1 = 1.2kΩ, R2 = 3.92kΩ, R3 = 2kΩ, T<sub>C</sub> = -40°C to +85°C. Typical values are at V<sub>CC</sub> = +5.0V and T<sub>C</sub> = +25°C, unless otherwise noted.) (Note 1)

PARAMETER	SYMBOL	CONDITIONS	MIN	TYP	MAX	UNITS
Supply Voltage	V <sub>CC</sub>	Reference to V <sub>CC</sub> , VCCLB, VCCLOGIC, VCCBIAS1, VCCBIAS2, VCCAMP	4.75	5.0	5.25	V
Total Supply Current	I <sub>CC</sub>	LB mixer disabled (LB_EN = 1)		134	156	mA
		LB mixer enabled (LB_EN = 0)		158	186	
<b>LOGIC INPUTS (DATA, CS, CLK, LB_EN)</b>						
Input High Voltage	V <sub>IH</sub>		2.4			V
Input Low Voltage	V <sub>IL</sub>				0.8	V
Input Current with Logic-High	I <sub>IH</sub>			0.01		μA
Input Current with Logic-Low	I <sub>IL</sub>			0.01		μA

## AC ELECTRICAL CHARACTERISTICS

(MAX2058 Typical Application Circuit, V<sub>CC</sub> = +4.75V to +5.25V, digital attenuators set for maximum gain, 700MHz ≤ f<sub>RF</sub> ≤ 1200MHz, 40MHz ≤ f<sub>LO</sub> ≤ 100MHz, T<sub>C</sub> = -40°C to +85°C. Typical values are at V<sub>CC</sub> = 5.0V, P<sub>IN</sub> = 0dBm, f<sub>RF</sub> = 940MHz, P<sub>LO</sub> = -6dBm, f<sub>LO</sub> = 45MHz, f<sub>LBOUT</sub> = f<sub>RF</sub> - f<sub>LO</sub>, and T<sub>C</sub> = +25°C, unless otherwise noted.) (Note 1)

PARAMETER	SYMBOL	CONDITIONS	MIN	TYP	MAX	UNITS	
RF Frequency (Note 2)		MAX2058	700		1200	MHz	
		MAX2059	1800		2200		
Small-Signal Gain	A <sub>v</sub>	f <sub>RF</sub> = 940MHz, T <sub>C</sub> = +25°C	8.4	10.5	12.8	dB	
Gain Variation vs. Temperature		All attenuation settings	T <sub>C</sub> = -40°C to +25°C			-0.014	dB/°C
			T <sub>C</sub> = +25°C to +85°C			-0.021	
Output Power	P <sub>OUT</sub>	P <sub>IN</sub> = 0dBm, f <sub>RF</sub> = 940MHz, T <sub>C</sub> = +25°C	8.4	10.5	12.8	dBm	
Output Power Flatness		P <sub>IN</sub> = 0dBm	800MHz to 900MHz			0.13	dB
			900MHz to 1000MHz			-0.52	
Attenuation Range					62	dB	
Output Third-Order Intercept Point	OIP3	Two tones: f <sub>RF1</sub> = 940MHz, f <sub>RF2</sub> = 941MHz, P <sub>OUT1</sub> = P <sub>OUT2</sub> = +5dBm			32.3	dBm	

# 700MHz to 1200MHz High-Linearity, SPI-Controlled DVGA with Integrated Loopback Mixer

**MAX2058**

## AC ELECTRICAL CHARACTERISTICS (continued)

(MAX2058 Typical Application Circuit,  $V_{CC} = +4.75V$  to  $+5.25V$ , digital attenuators set for maximum gain,  $700MHz \leq f_{RF} \leq 1200MHz$ ,  $40MHz \leq f_{LO} \leq 100MHz$ ,  $T_C = -40^\circ C$  to  $+85^\circ C$ . Typical values are at  $V_{CC} = 5.0V$ ,  $P_{IN} = 0dBm$ ,  $f_{RF} = 940MHz$ ,  $P_{LO} = -6dBm$ ,  $f_{LO} = 45MHz$ ,  $f_{LBOUT} = f_{RF} - f_{LO}$ , and  $T_C = +25^\circ C$ , unless otherwise noted.) (Note 1)

PARAMETER	SYMBOL	CONDITIONS	MIN	TYP	MAX	UNITS
Output -1dB Compression Point (Note 3)	OP <sub>1dB</sub>			19		dBm
RMS Error Vector Magnitude	EVM	P <sub>OUT</sub> = +12dBm, EDGE modulation		0.5		%
Spurious Emissions in 30kHz Bandwidth (Note 4)		P <sub>OUT</sub> = +12dBm, EDGE modulation	200kHz offset	-39.2		dBc
			400kHz offset	-73.5		
			600kHz offset	-82.7		
			1.2MHz offset	-85.7		
Noise Figure	NF			6.8		dB
Input Return Loss		50Ω source, minimum attenuation setting		18		dB
Output Return Loss		50Ω load, minimum attenuation setting		20		dB
<b>5-BIT DIGITAL ATTENUATORS</b>						
Insertion Loss		Attenuator measured separately Z <sub>S</sub> = Z <sub>L</sub> = 50Ω		3.3		dB
Input Third-Order Intercept Point	IIP3	Attenuator measured separately Z <sub>S</sub> = Z <sub>L</sub> = 50Ω, two tones: f <sub>RF1</sub> = 940MHz, f <sub>RF2</sub> = 941MHz, P <sub>IN1</sub> = P <sub>IN2</sub> = +5dBm		44		dBm
Control Range				31		dB
Attenuation Step Size Variation vs. Frequency		800MHz to 900MHz		±0.08		dB
		900MHz to 1000MHz		±0.06		
Attenuation Variation vs. Temperature		800MHz to 1000MHz, T <sub>C</sub> = -40°C to +25°C		±0.002		dB/°C
		800MHz to 1000MHz, T <sub>C</sub> = +25°C to +85°C		±0.003		
Step Size				1		dB
Relative Step Accuracy		800MHz to 1000MHz		-0.2 +0.4		dB
Absolute Step Accuracy		800MHz to 1000MHz		-0.2 +0.5		dB
Spurious Emissions in 300kHz Bandwidth (Note 5)		No RF input, attenuator A stepped from 0 to 2dB, 7dB to 9dB, 15dB to 17dB, 0 to 31dB, 31dB to 0dB, with attenuator B at 0dB; attenuator B stepped from 0 to 2dB, 7dB to 9dB, 15dB to 17dB, 0 to 31dB, 31dB to 0dB, with attenuator A at 0dB		-85		dBm
Switching Speed		From chip select transitioning high to the output settling to within 1dB of steady state output		0.3		μs

# 700MHz to 1200MHz High-Linearity, SPI-Controlled DVGA with Integrated Loopback Mixer

## AC ELECTRICAL CHARACTERISTICS (continued)

(MAX2058 Typical Application Circuit,  $V_{CC} = +4.75V$  to  $+5.25V$ , digital attenuators set for maximum gain,  $700MHz \leq f_{RF} \leq 1200MHz$ ,  $40MHz \leq f_{LO} \leq 100MHz$ ,  $T_C = -40^\circ C$  to  $+85^\circ C$ . Typical values are at  $V_{CC} = 5.0V$ ,  $P_{IN} = 0dBm$ ,  $f_{RF} = 940MHz$ ,  $P_{LO} = -6dBm$ ,  $f_{LO} = 45MHz$ ,  $f_{LBOU} = f_{RF} - f_{LO}$ , and  $T_C = +25^\circ C$ , unless otherwise noted.) (Note 1)

PARAMETER	SYMBOL	CONDITIONS	MIN	TYP	MAX	UNITS
<b>LOOPBACK MIXER</b>						
LO Frequency (Note 2)	$f_{LO}$		40		100	MHz
LO Input Power	$P_{LO}$			-6	0	dBm
Output Power (Note 6)		$P_{IN} = +5dBm$ , $f_{RF} = 940MHz$ , $T_C = +25^\circ C$	-14.7	-12.7	-10.8	dBm
Gain Accuracy		$P_{IN} = +5dBm$ , $T_C = -40^\circ C$ to $+25^\circ C$	800MHz to 900MHz		$\pm 1.7$	dB
			900MHz to 1000MHz		$\pm 1.7$	
Output Third-Order Intercept Point (Note 6)	OIP3	Two tones: $f_{RF1} = 940MHz$ , $f_{RF2} = 940.2MHz$ , $P_{IN1} = P_{IN2} = +2dBm$ , $T_C = +25^\circ C$		10.6		dBm
Output Noise Floor		$P_{IN} = +5dBm$		-137		dBc/Hz
ON/OFF Switching Time		LB_EN enable time		0.12		$\mu s$
		LB_EN disable time		0.12		
LBOU to ATTEN_OUTB Isolation		Mixer enabled, attenuators A and B both set to 31dB, $P_{IN} = +5dBm$		67		dB
ATTEN_OUTB to LBOU Isolation		Mixer disabled, $P_{IN} = 0dBm$		50		dB
Output Return Loss		Mixer enabled, $50\Omega$ load		22		dB
		Mixer disabled, $50\Omega$ load		23		
LO Port Return Loss		$50\Omega$ source		32		dB
<b>SERIAL PERIPHERAL INTERFACE (SPI)</b>						
Maximum Clock Speed				38		MHz
Data to Clock Setup Time	$t_{CS}$			1		ns
Data to Clock Hold Time	$t_{CH}$			9		ns
Clock to $\overline{CS}$ Setup Time	$t_{ES}$			4		ns
$\overline{CS}$ Positive Pulse Width	$t_{EW}$			18		ns
$\overline{CS}$ Negative Pulse Width	$t_{EWN}$			24		ns
CLOCK Pulse Width	$t_{CW}$			13		ns

**Note 1:** All limits include external component losses. Output measurements taken at RFOUT or LBOU ports of the Typical Application Circuit.

**Note 2:** Operating outside this range is possible, but with degraded performance of some parameters.

**Note 3:** Compression point characterized. It is advisable not to continuously operate the VGA RF input above +15dBm.

**Note 4:** Input RF source contribution to spurious emissions (Agilent ESG 4435B, PSA E4443A): 200kHz = -39.2dBc, 400kHz = -73.5dBc, 600kHz = -83.2dBc, 1.2MHz = -85.7dBc

**Note 5:** No SPI clock input applied.

**Note 6:** Guaranteed by design and characterization.

# 700MHz to 1200MHz High-Linearity, SPI-Controlled DVGA with Integrated Loopback Mixer

**MAX2058**

## Typical Operating Characteristics

(MAX2058 Typical Application Circuit,  $V_{CC} = +4.75V$  to  $+5.25V$ , digital attenuators set for maximum gain,  $700MHz \leq f_{RF} \leq 1200MHz$ ,  $40MHz \leq f_{LO} \leq 100MHz$ ,  $T_C = -40^\circ C$  to  $+85^\circ C$ . Typical values are at  $V_{CC} = 5.0V$ ,  $P_{IN} = 0dBm$ ,  $f_{RF} = 940MHz$ ,  $f_{LO} = 45MHz$ ,  $f_{LBOUT} = f_{RF} - f_{LO}$ , and  $T_C = +25^\circ C$ , unless otherwise noted.)

**GAIN vs. RF FREQUENCY (MAXIMUM GAIN)**

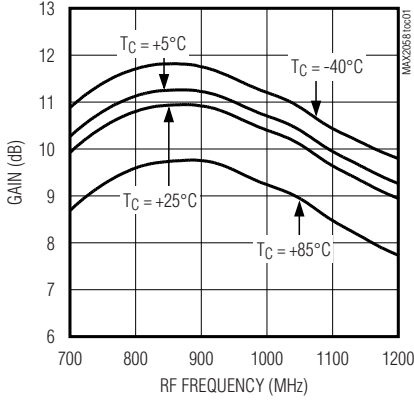

**GAIN vs. RF FREQUENCY (MAXIMUM GAIN)**

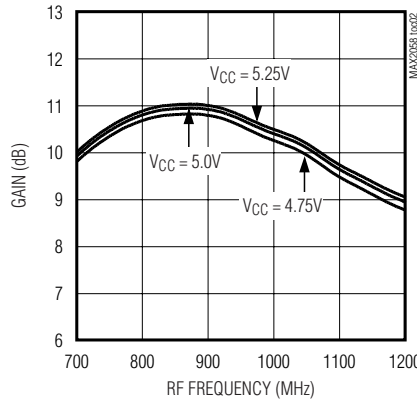

**GAIN vs. RF FREQUENCY ADJUSTING ATTEN A**

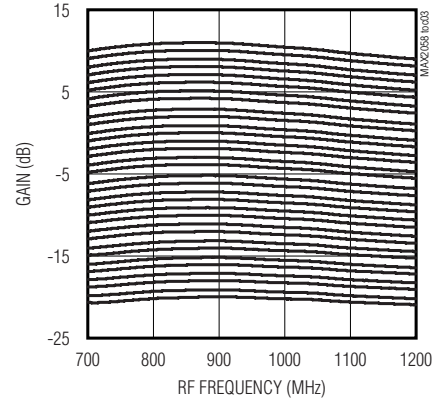

**ATTEN A ABS ACCURACY vs. RF FREQUENCY**

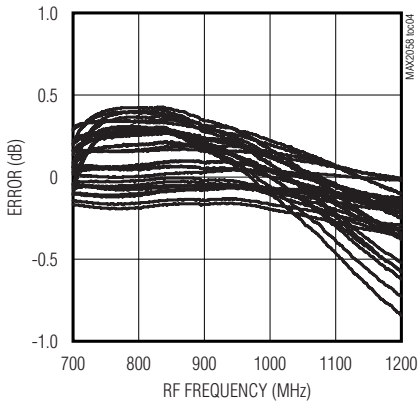

**ATTEN A REL ACCURACY vs. RF FREQUENCY**

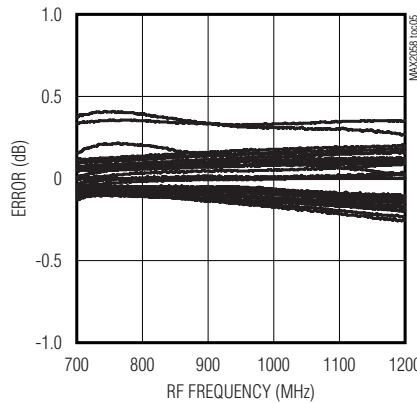

**GAIN vs. RF FREQUENCY ADJUSTING ATTEN B**

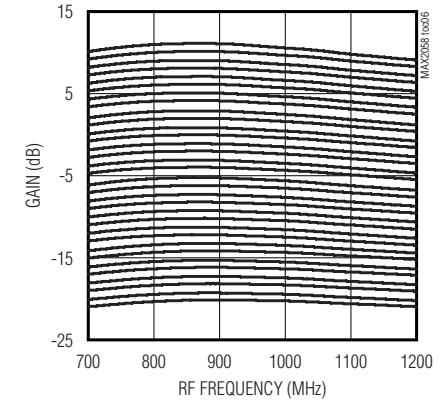

**ATTEN B ABS ACCURACY vs. RF FREQUENCY**

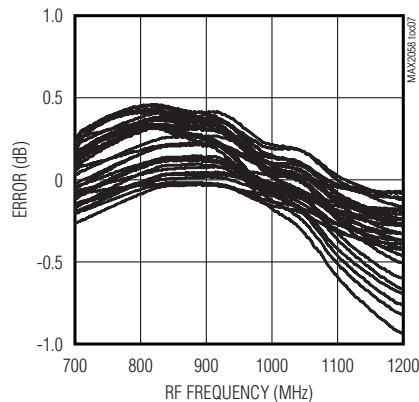

**ATTEN B REL ACCURACY vs. RF FREQUENCY**

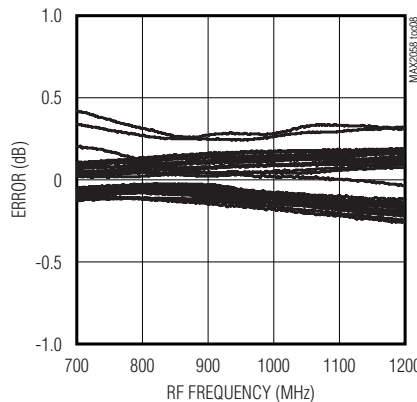

**OUTPUT IP3 vs. RF FREQUENCY**

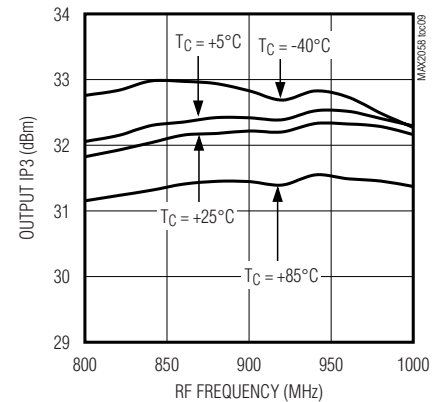

# 700MHz to 1200MHz High-Linearity, SPI-Controlled DVGA with Integrated Loopback Mixer

## Typical Operating Characteristics (continued)

(MAX2058 Typical Application Circuit,  $V_{CC} = +4.75V$  to  $+5.25V$ , digital attenuators set for maximum gain,  $700MHz \leq f_{RF} \leq 1200MHz$ ,  $40MHz \leq f_{LO} \leq 100MHz$ ,  $T_C = -40^\circ C$  to  $+85^\circ C$ . Typical values are at  $V_{CC} = 5.0V$ ,  $P_{IN} = 0dBm$ ,  $f_{RF} = 940MHz$ ,  $f_{LO} = 45MHz$ ,  $f_{LBOUT} = f_{RF} - f_{LO}$ , and  $T_C = +25^\circ C$ , unless otherwise noted.)

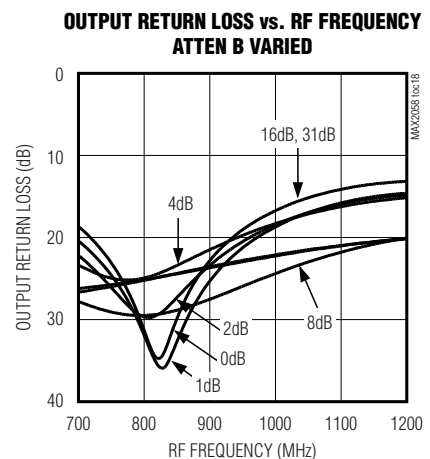
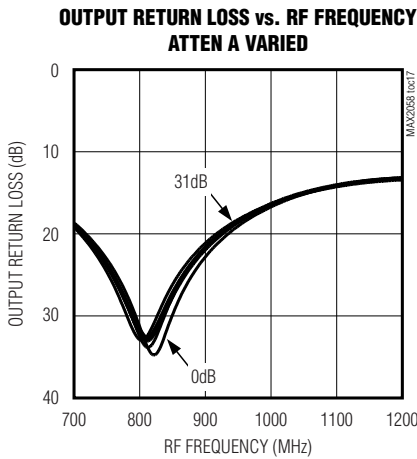
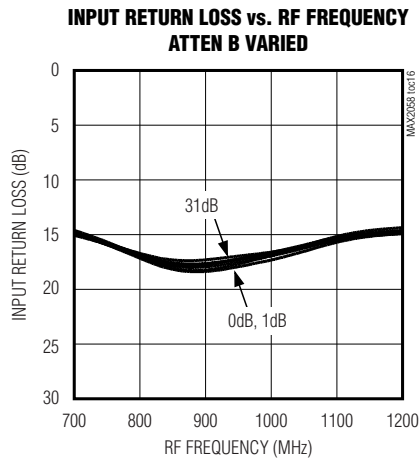
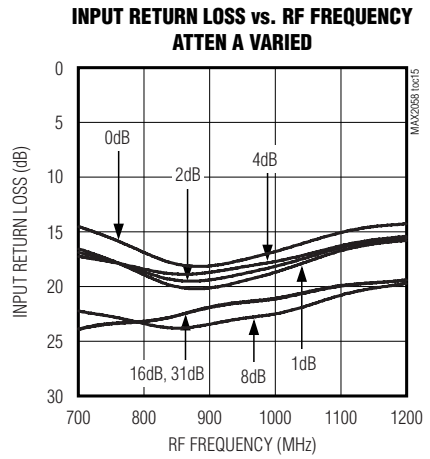
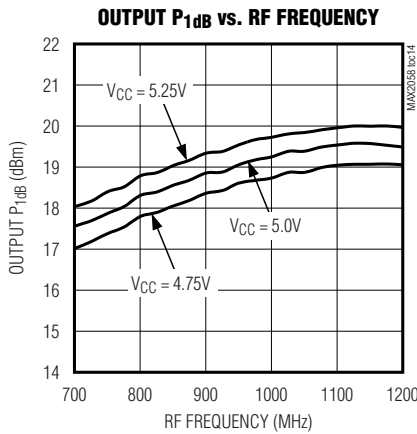
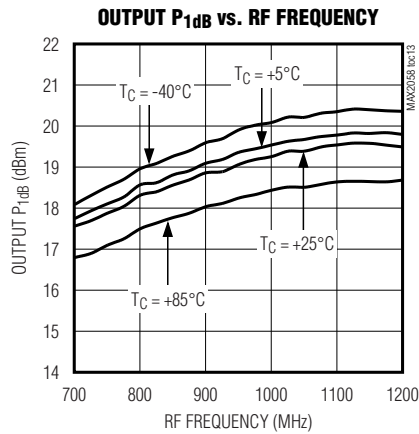
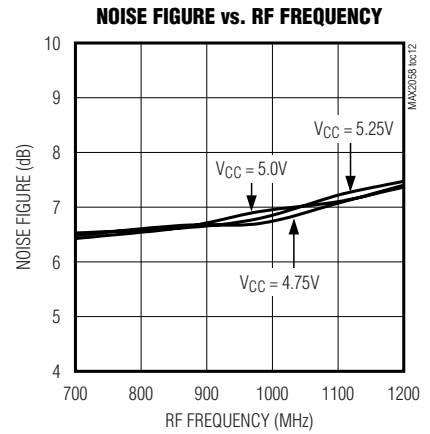
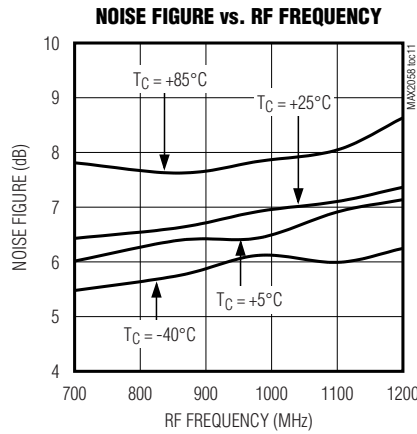
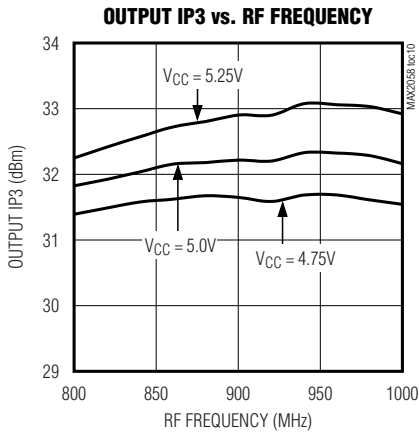

# 700MHz to 1200MHz High-Linearity, SPI-Controlled DVGA with Integrated Loopback Mixer

## Typical Operating Characteristics (continued)

(MAX2058 Typical Application Circuit,  $V_{CC} = +4.75V$  to  $+5.25V$ , digital attenuators set for maximum gain,  $700MHz \leq f_{RF} \leq 1200MHz$ ,  $40MHz \leq f_{LO} \leq 100MHz$ ,  $T_C = -40^\circ C$  to  $+85^\circ C$ . Typical values are at  $V_{CC} = 5.0V$ ,  $P_{IN} = 0dBm$ ,  $f_{RF} = 940MHz$ ,  $f_{LO} = 45MHz$ ,  $f_{LBOUT} = f_{RF} - f_{LO}$ , and  $T_C = +25^\circ C$ , unless otherwise noted.)

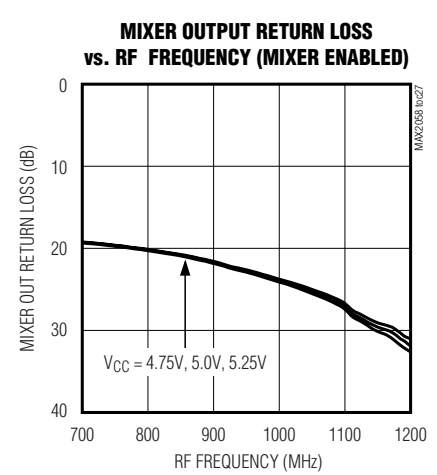
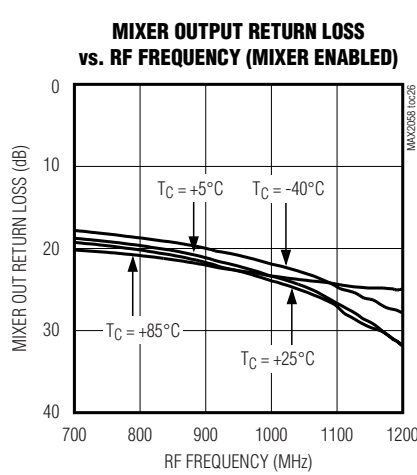
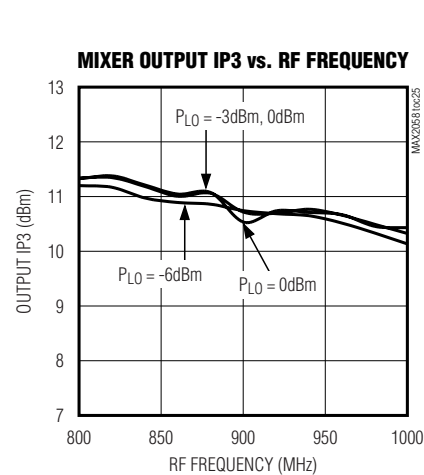
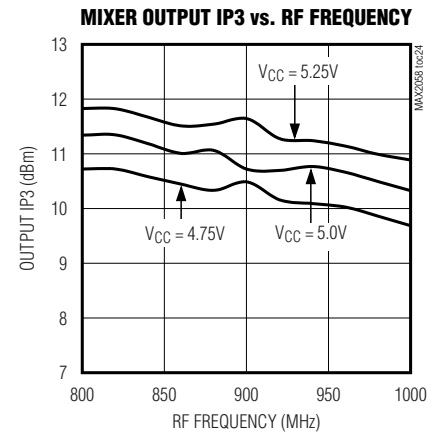
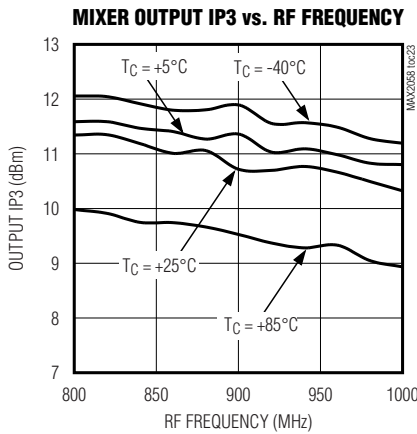
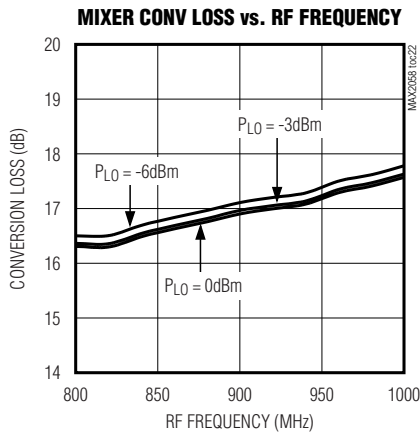
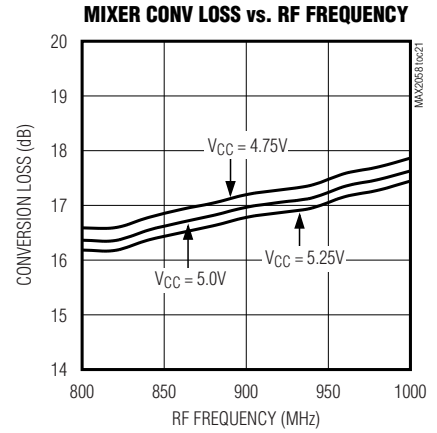
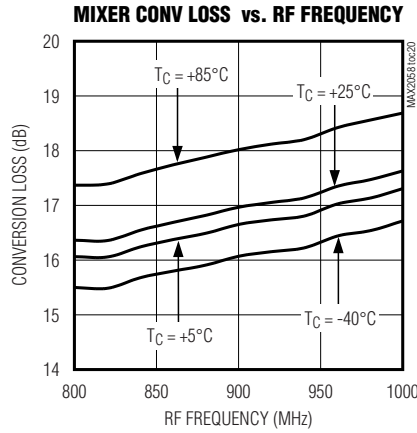
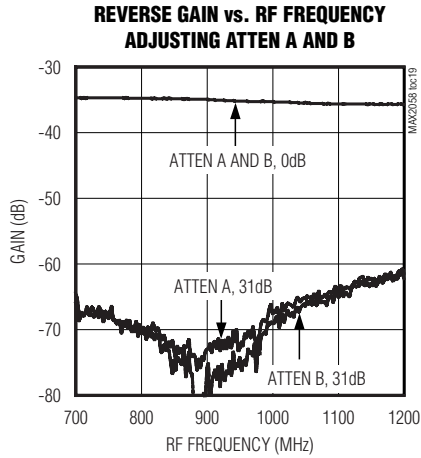

# 700MHz to 1200MHz High-Linearity, SPI-Controlled DVGA with Integrated Loopback Mixer

## Typical Operating Characteristics (continued)

(MAX2058 Typical Application Circuit,  $V_{CC} = +4.75V$  to  $+5.25V$ , digital attenuators set for maximum gain,  $700MHz \leq f_{RF} \leq 1200MHz$ ,  $40MHz \leq f_{LO} \leq 100MHz$ ,  $T_C = -40^\circ C$  to  $+85^\circ C$ . Typical values are at  $V_{CC} = 5.0V$ ,  $P_{IN} = 0dBm$ ,  $f_{RF} = 940MHz$ ,  $f_{LO} = 45MHz$ ,  $f_{LBOUT} = f_{RF} - f_{LO}$ , and  $T_C = +25^\circ C$ , unless otherwise noted.)

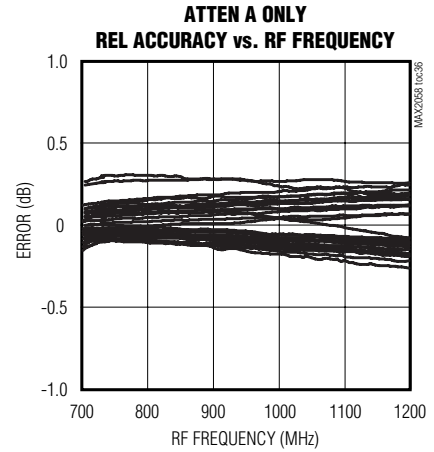
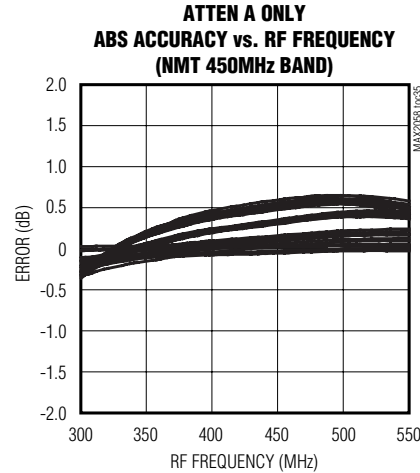
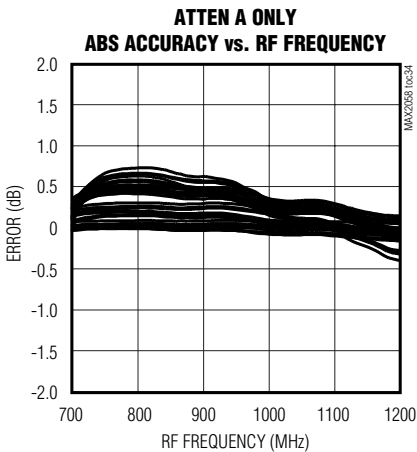
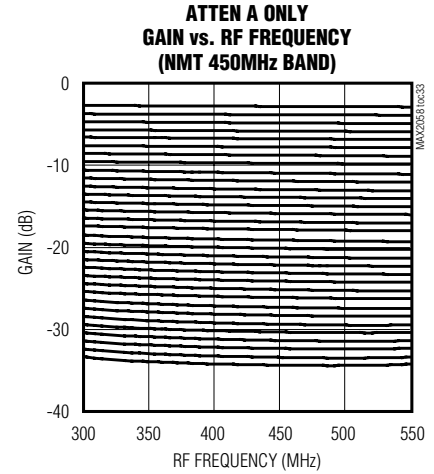
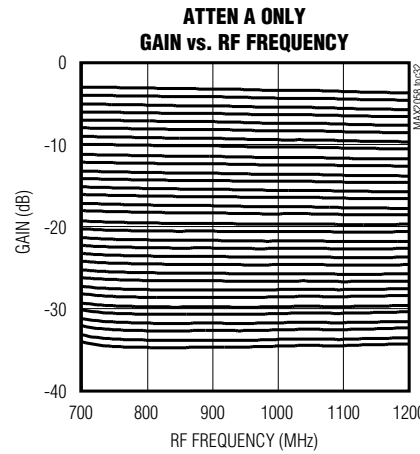
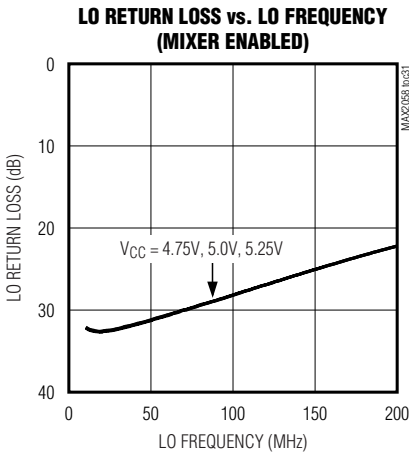
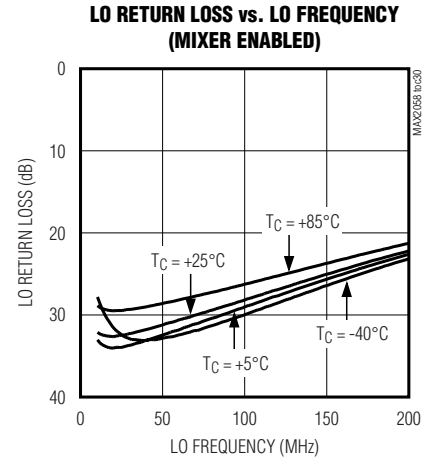
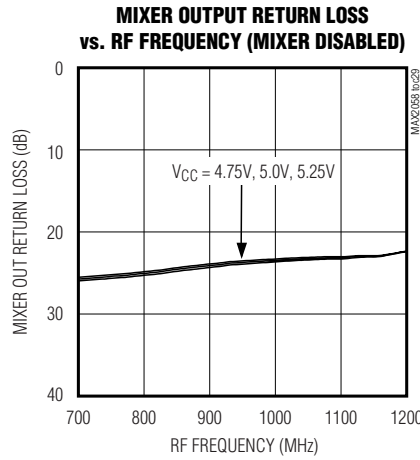
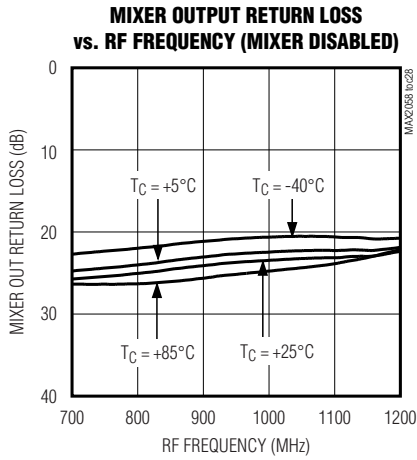



# 700MHz to 1200MHz High-Linearity, SPI-Controlled DVGA with Integrated Loopback Mixer

## Typical Operating Characteristics (continued)

(MAX2058 Typical Application Circuit,  $V_{CC} = +4.75V$  to  $+5.25V$ , digital attenuators set for maximum gain,  $700MHz \leq f_{RF} \leq 1200MHz$ ,  $40MHz \leq f_{LO} \leq 100MHz$ ,  $T_C = -40^\circ C$  to  $+85^\circ C$ . Typical values are at  $V_{CC} = 5.0V$ ,  $P_{IN} = 0dBm$ ,  $f_{RF} = 940MHz$ ,  $f_{LO} = 45MHz$ ,  $f_{LBOUT} = f_{RF} - f_{LO}$ , and  $T_C = +25^\circ C$ , unless otherwise noted.)

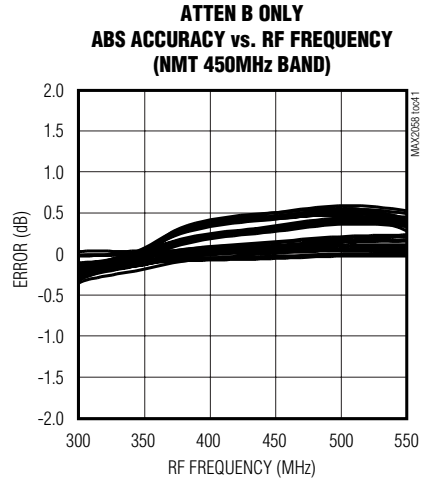
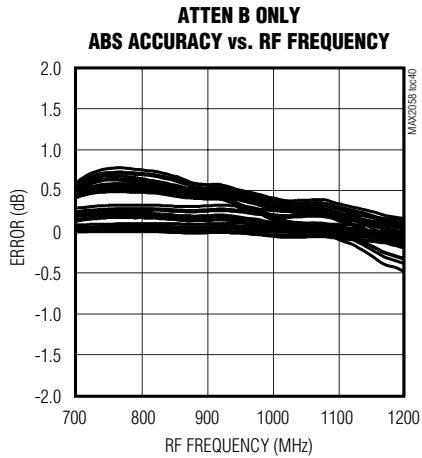
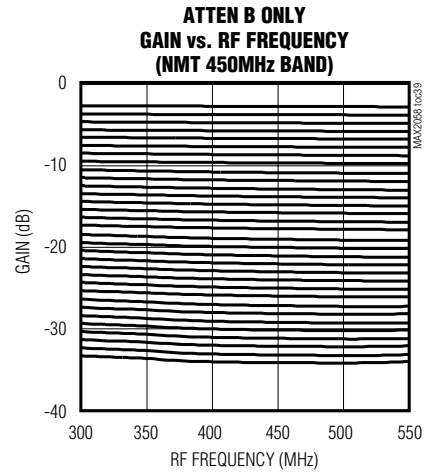
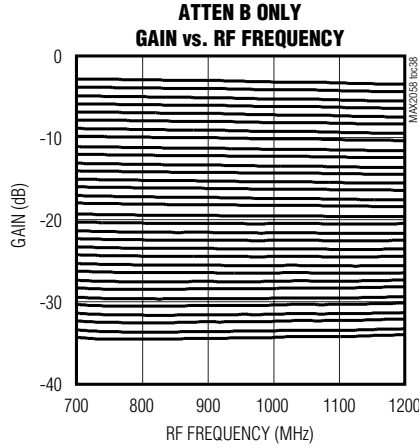
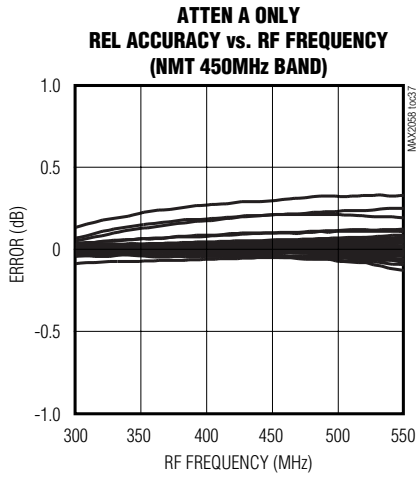

# 700MHz to 1200MHz High-Linearity, SPI-Controlled DVGA with Integrated Loopback Mixer

## Typical Operating Characteristics (continued)

(MAX2058 Typical Application Circuit,  $V_{CC} = +4.75V$  to  $+5.25V$ , digital attenuators set for maximum gain,  $700MHz \leq f_{RF} \leq 1200MHz$ ,  $40MHz \leq f_{LO} \leq 100MHz$ ,  $T_C = -40^\circ C$  to  $+85^\circ C$ . Typical values are at  $V_{CC} = 5.0V$ ,  $P_{IN} = 0dBm$ ,  $f_{RF} = 940MHz$ ,  $f_{LO} = 45MHz$ ,  $f_{LBOUT} = f_{RF} - f_{LO}$ , and  $T_C = +25^\circ C$ , unless otherwise noted.)

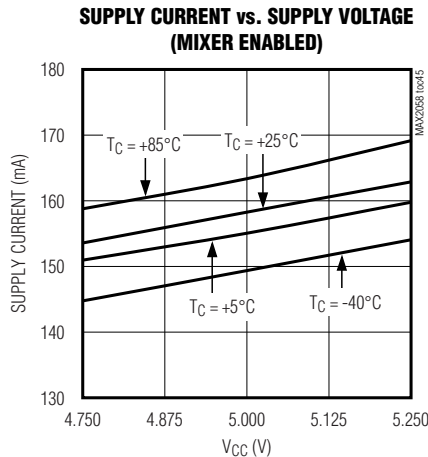
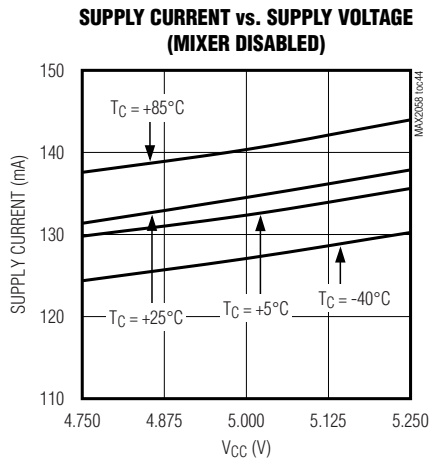
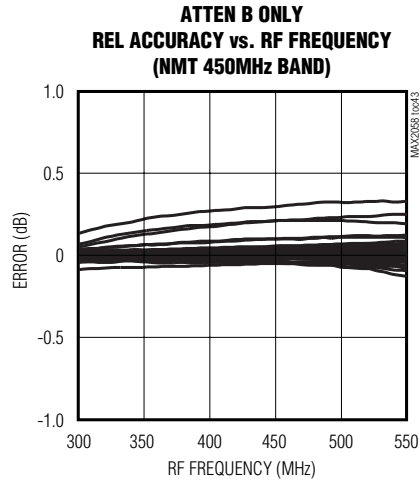
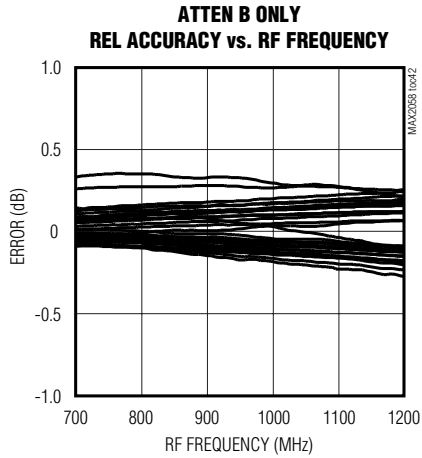

# 700MHz to 1200MHz High-Linearity, SPI-Controlled DVGA with Integrated Loopback Mixer

## Pin Description

**MAX2058**

PIN	NAME	FUNCTION
1	LO+	Loopback Mixer Local Oscillator Positive Input
2	LO-	Loopback Mixer Local Oscillator Negative Input
3	VCCLB	Loopback Mixer Supply Voltage. +5V supply for the internal loopback mixer. Bypass to GND with 100pF and 0.1μF capacitors as close as possible to the pin.
4	LBOU	Loopback Mixer RF Output. Internally matched to 50Ω. AC-couple with a capacitor.
5	LB_EN	Loopback Mixer Logic Input. Set to logic-low 0 to enable the mixer. Set to logic-high 1 to disable the mixer.
6	DATA	SPI Digital Data Input
7	CLK	SPI Clock Input
8	$\overline{CS}$	SPI Chip-Select Input
9	VCCLOGIC	Logic Supply Voltage. +5V supply for the internal logic circuitry. Bypass to GND with 100pF and 0.1μF capacitors as close as possible to the pin.
10, 11, 13, 14, 16, 17, 19, 22, 24, 25, 26, 30, 32, 34, 35, 37, 38	GND	Ground
12	ATTEN_OUTB	Attenuator B Output. Internally matched to 50Ω.
15	VCC	Attenuator B Supply. +5V supply for attenuator B. Bypass to GND with 100pF and 0.01μF capacitors as close as possible to the pin.
18	ATTEN_INB	Attenuator B Input. Internally matched to 50Ω.
20	RSET2	Output Amplifier Bias-Current-Setting Resistor. Sets the bias current for the output amplifier stage. Connect a 3.92kΩ resistor to ground.
21	VCCBIAS2	Bias Circuit Supply Voltage. +5V supply for the internal bias circuitry. Bypass to GND with 1000pF and 0.1μF capacitors as close as possible to the pin.
23	AMPOUT	RF Amplifier Output. Internally matched to 50Ω.
27	VCCAMP	RF Amplifier Supply Voltage. +5V supply for the RF amplifier. Bypass to GND with 1000pF and 0.1μF capacitors as close as possible to the pin.
28	AMPIN	RF Amplifier Input. Internally matched to 50Ω.
29	VCCBIAS1	Bias Circuit Supply Voltage. +5V supply for the internal bias circuitry. Bypass to GND with 1000pF and 0.1μF capacitors as close as possible to the pin.
31	RSET1	Input Amplifier Bias-Current-Setting Resistor. Sets the bias current for the input amplifier stage. Connect a 1.2kΩ resistor to ground.
33	ATTEN_OUTA	Attenuator A Output. Internally matched to 50Ω.
36	VCC	Attenuator A Supply Voltage. +5V supply for attenuator A. Bypass to GND with 100pF and 0.01μF capacitors as close as possible to the pin.
39	ATTEN_INA	Attenuator A Input. Internally matched to 50Ω.
40	LBBIAS	Loopback Mixer Bias-Current-Setting Resistor. Sets the bias current for the mixer. Connect a 2kΩ resistor to ground.
EP	GND	Exposed Ground Paddle. Solder the exposed paddle to GND using multiple vias.

# 700MHz to 1200MHz High-Linearity, SPI-Controlled DVGA with Integrated Loopback Mixer

## Detailed Description

The MAX2058 high-linearity DVGA consists of two 5-bit, 31dB digital attenuators, a fixed-gain two-stage driver amplifier, a loopback mixer, and a serial interface to control the attenuators. This high level of component integration makes the MAX2058 ideal for base-station transmitter applications. The MAX2058 is designed to operate in the 700MHz to 1200MHz frequency ranges. The overall cascaded performance of the MAX2058 produces a typical 10.5dB gain, a +32.3dBm OIP3, a 19dBm OP1dB, and a total 62dB gain-control range.

### 5-Bit Attenuators

The MAX2058 integrates two 5-bit digital attenuators to achieve a high dynamic range. Each attenuator has a 31dB control range, a 1dB step size, and is programmed with the 3-wire SPI. See the *Applications Information* section and Table 1 for attenuator programming details. The attenuators can be used for both static and dynamic power control.

**Table 1. Attenuator Programming**

ATTENUATOR A (5 MSBs)	ATTENUATOR B (5 LSBs)
Bit 9 = 16dB step	Bit 4 = 16dB step
Bit 8 = 8dB step	Bit 3 = 8dB step
Bit 7 = 4dB step	Bit 2 = 4dB step
Bit 6 = 2dB step	Bit 1 = 2dB step
Bit 5 = 1dB step	Bit 0 = 1dB step

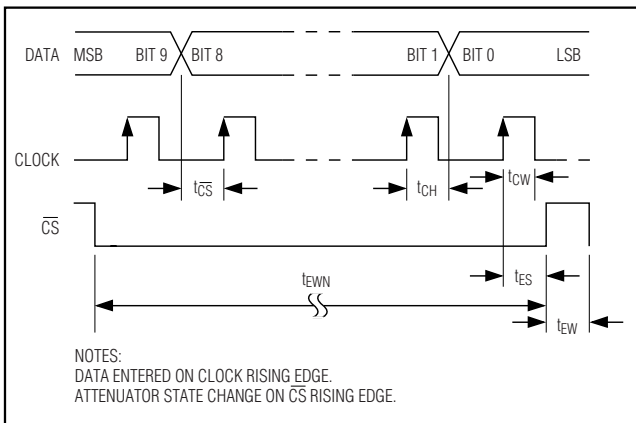

Figure 1. SPI Timing Diagram

### Driver Amplifier

The MAX2058 includes a two-stage medium power amplifier with a fixed 17.5dB gain. The driver amplifier circuit is optimized for high linearity and medium output power capability for the 800MHz to 1000MHz frequency range. The driver amplifier is intended to amplify a modulated signal and drive a high-power amplifier in base-station transmitters. In a typical application, the driver amplifier is cascaded in between the two digital attenuators. See the *Typical Application Circuit*.

The two-stage amplifier stage can be disabled for applications where only the digital attenuators and/or loopback mixer are used. To disable the two-stage amplifier, ground or leave unconnected the amplifier supplies VCCBIAS2, VCCAMP, VCCBIAS1, and also the inputs for setting the amplifier bias currents RSET1, RSET2. This reduces the supply current by approximately 132mA under typical conditions.

### Loopback Mixer

The MAX2058 loopback mixer uses a double-balanced active architecture designed to operate with a 700MHz to 1200MHz RF frequency range, and a 40MHz to 100MHz LO frequency range. The RF port of the mixer is connected internally (with an on-chip switch) to the input of the first attenuator stage. The mixer's IF port is matched for a single-ended 50Ω impedance, while the LO port requires a differential input impedance of 100Ω.

The loopback mixer facilitates a self-diagnostic mode for cellular transceivers, whereby the Tx band signal at the input of the mixer can be translated up or down to the corresponding Rx band. This translated signal can then be fed back to the radio's receiver for complete Tx/Rx loop diagnostics. The loopback mixer is enabled and disabled with LB\_EN. Set LB\_EN to a logic-low 0 to enable the mixer, set LB\_EN to a logic-high 1 to disable the mixer.

## Applications Information

### SPI Interface and Attenuator Settings

The two 5-bit attenuators are programmed with the 3-wire SPI/MICROWIRE-compatible serial interface using 10-bit words. Bit 9 of the 10-bit data is shifted in first, along with all remaining data bits, on the rising edge of the clock regardless of CS being high or low. Once all the data bits are shifted in, all will be sent to the attenuators on the rising edge of CS, thus changing the attenuator state. For standard SPI operation, pull CS low for the duration of a valid 10-bit data set (tEWN). This CS negative pulse width includes the setup time of the rising clock edge to CS transitioning high (tES). See Figure 1.

# 700MHz to 1200MHz High-Linearity, SPI-Controlled DVGA with Integrated Loopback Mixer

The 5 MSBs of the 10-bit word program attenuator A, and the 5 LSBs of the 10-bit word program attenuator B. Each bit sets the attenuators to a corresponding attenuation level. For example, logic-low 0 for bit 5 and bit 0 of attenuator A and B, respectively, sets both attenuators at 1dB. 00000 configures both attenuators for 31dB attenuation and 11111 sets for 0dB attenuation. See Table 1 for programming details.

### External Bias

Bias currents for the two-stage amplifier and the loopback mixer are set and optimized with external resistors. Resistor R1 (pin 31) sets the bias current for the input amplifier, R2 (pin 20) sets the bias current for the output amplifier, and R3 (pin 40) sets the bias for the loopback mixer. The external biasing resistor values can be increased for reduced current operation at the expense of performance. Contact the factory for details.

### Board Layout

The pin configuration of the MAX2058 has been optimized to facilitate a very compact physical layout of the device and its associated discrete components.

The exposed paddle (EP) of the MAX2058's thin QFN-EP package provides a low thermal-resistance path to the die. It is important that the PC board on which the MAX2058 is mounted be designed to conduct heat

from the EP. In addition, provide the EP with a low-inductance path to electrical ground. The EP **MUST** be soldered to a ground plane on the PC board, either directly or through an array of plated via holes.

**Table 2. Component List Referring to the Typical Application Circuit**

COMPONENT	VALUE	DESCRIPTION
C1, C4, C10, C13, C16	0.1μF	Microwave capacitors (0603)
C2, C5, C8, C17	100pF	Microwave capacitors (0402)
C3, C6, C14, C19	47pF	Microwave capacitors (0402)
C7, C18	0.01μF	Microwave capacitors (0402)
C9, C12, C15	1000pF	Microwave capacitors (0402)
C11	3.9pF	Microwave capacitor (0402)
R1	1.2kΩ	±1% resistor (0402)
R2	3.92kΩ	±1% resistor (0402)
R3	2.0kΩ	±1% resistor (0402)
R4	110Ω	±1% resistor (0402)
T1	2:1	RF transformer (100:50) Mini-Circuits TC2-1T
U1	—	<b>MAX2058 MAXIM IC</b>

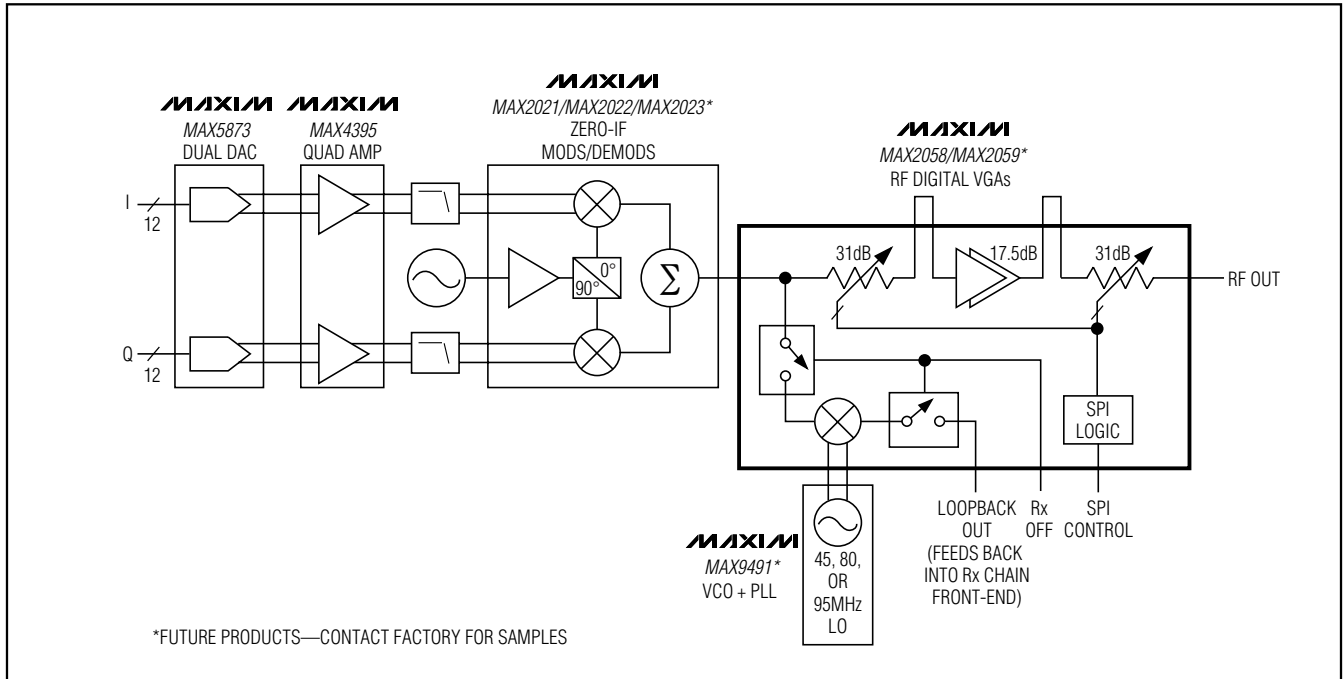

Figure 2. Direct Conversion Transmitter for GSM/EDGE Basestations

# 700MHz to 1200MHz High-Linearity, SPI-Controlled DVGA with Integrated Loopback Mixer

## Direct-Conversion Base-Station Transmitter

The MAX2058/MAX2059 are designed to interface directly with Maxim's direct-conversion quadrature modulators and high-speed DACs to provide a complete solution for GSM/EDGE base-station transmitter applications. See Figure 2. The MAX2058/MAX2059,

together with the MAX2021/MAX2022/MAX2023\* direct-conversion modulators/demodulators, the MAX5873 dual-channel DAC, and the MAX4395 quad amplifier, form an ideal total transmitter lineup. This overall system is highly efficient and low cost, while maintaining high linearity and low noise performance.

## Typical Application Circuit

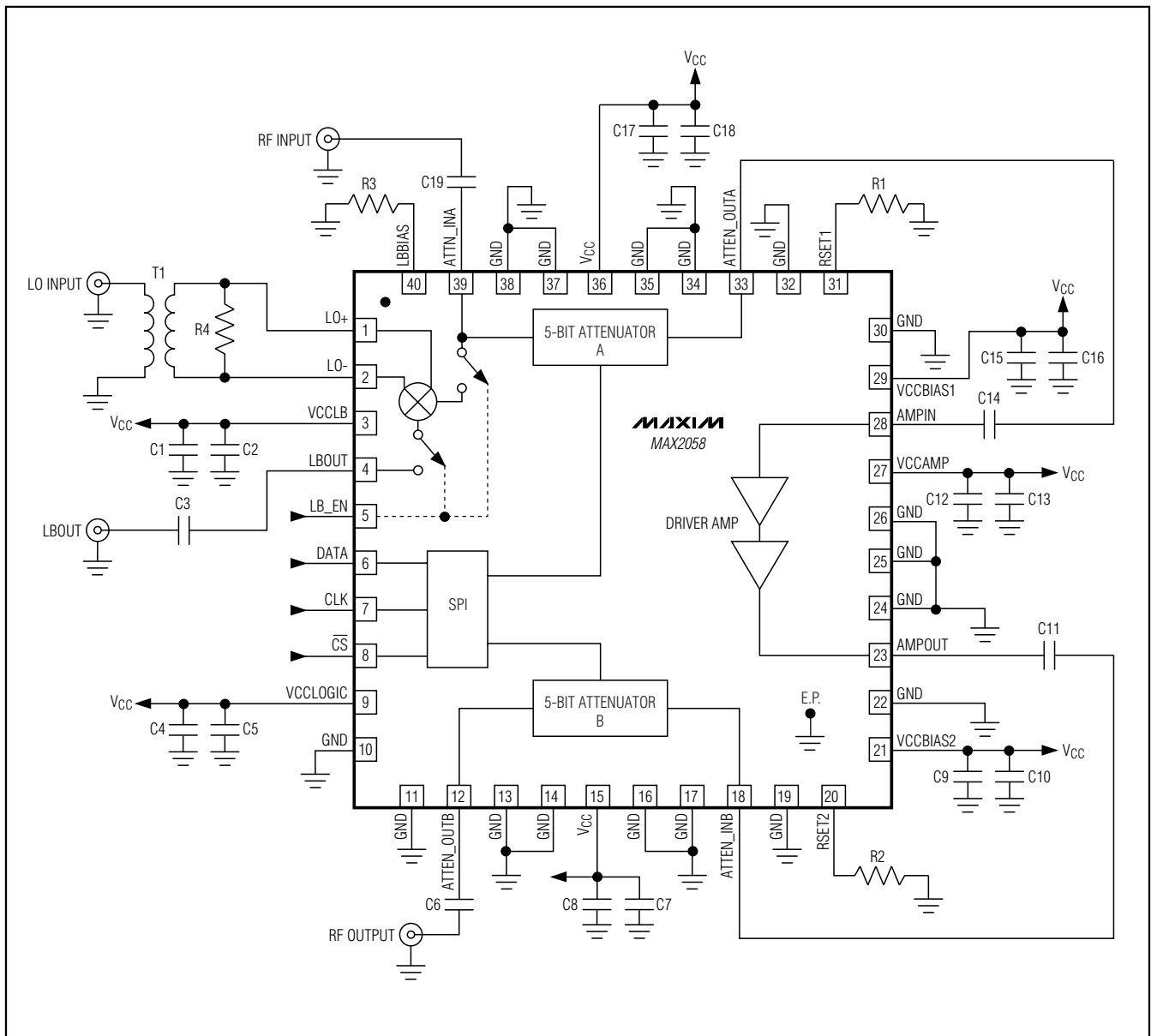

# 700MHz to 1200MHz High-Linearity, SPI-Controlled DVGA with Integrated Loopback Mixer

## Pin Configuration/Functional Diagram

**MAX2058**

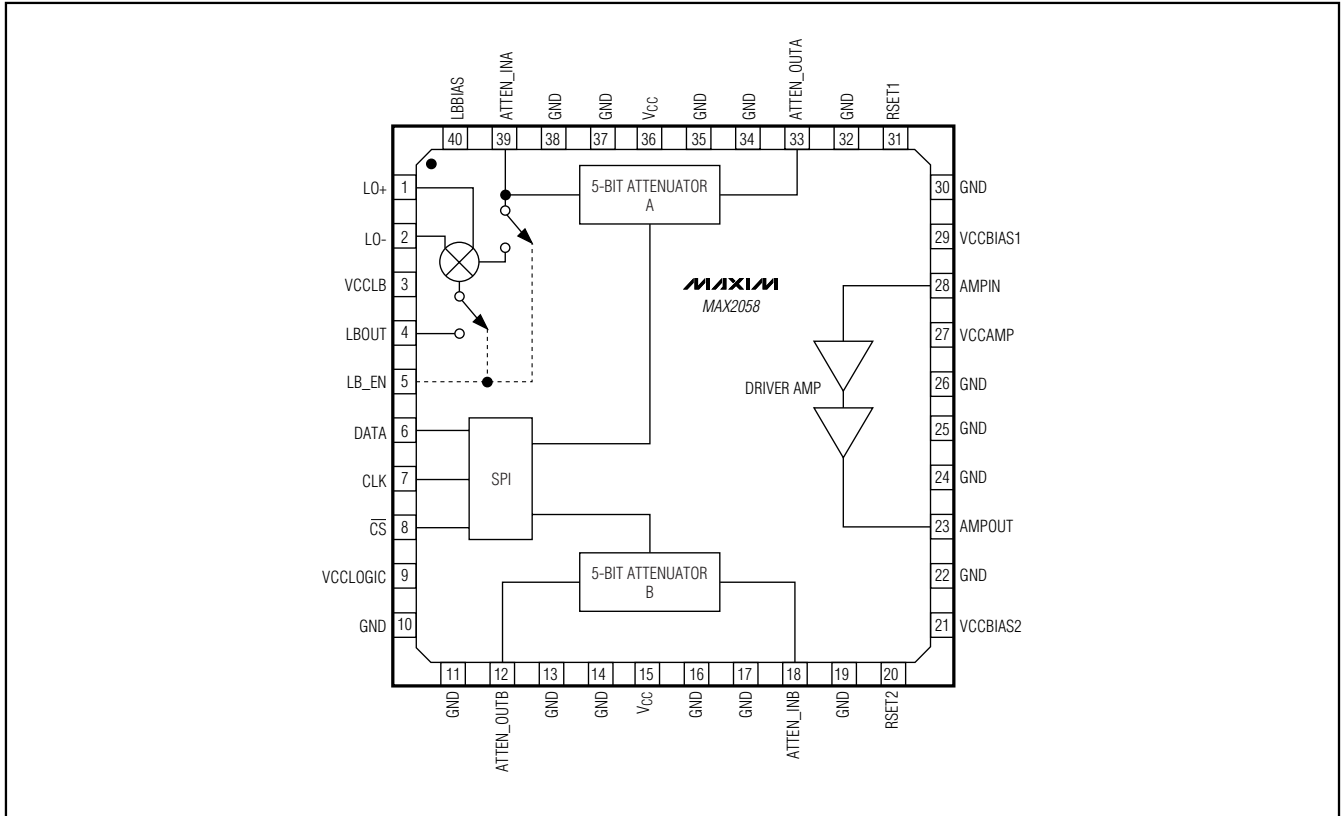

### Chip Information

PROCESS: SiGe BiCMOS

### Package Information

For the latest package outline information, go to [www.maxim-ic.com/packages](http://www.maxim-ic.com/packages).

Maxim cannot assume responsibility for use of any circuitry other than circuitry entirely embodied in a Maxim product. No circuit patent licenses are implied. Maxim reserves the right to change the circuitry and specifications without notice at any time.

Maxim Integrated Products, 120 San Gabriel Drive, Sunnyvale, CA 94086 408-737-7600 \_\_\_\_\_ 15

© 2006 Maxim Integrated Products

**MAXIM** is a registered trademark of Maxim Integrated Products, Inc.