



RF Components
Short-range Radios & RFICs



Wireless Mesh & Sensor Networking
OEM Modules and Standalone Products



Wireless Industrial Automation & Control Networking
OEM Modules and Standalone Products



Wireless LAN / WiFi™
Networking

Wireless Device Networking

From meters to miles...
Delivering M2M

Industrial • Commercial • Consumer • Medical • Automotive • Military

ZigBee® • 802.15.4 • Proprietary MESH • Proprietary FHSS • Bluetooth™ • 802.11 • Transceiver • Transmitter • Receiver • RFIC • SAW • Crystal-based



RFM Integration Solutions Solves the M2M Puzzle

RFM Integration Solutions solves puzzling wireless network application and asset management challenges by helping you select and integrate the best mix of "off-the-shelf" and / or custom systems for your M2M solutions.

Backed by 25+ years in wireless device communications and 15+ years in enterprise asset management and computerized maintenance management, RFM Integration Solutions is the perfect partner when you need help delivering customized M2M solutions.

Custom RF Modules or Standalone Wireless Products

- Design and manufacture RF modules and/or radio modems and gateways to meet customer specifications
- Integration of current RFM technology in packaged standalone products for sensor applications and beyond

Custom Firmware / Software

- Customize firmware to adapt feature / functionality of RFM ready-made RF modules or standalone RF devices to fit specialized requirements
- Customize RFM Aleier asset management software for condition monitoring applications



Complete Condition-based Monitoring or Maintenance

- Comprehensive CBM solution that include sensors, wireless networking, application software, and hosted data services
- CBM implementation services and best-practices maintenance consulting

End-to-end Sensor Networks

- Integrated solution complete with sensor nodes, wireless networks and gateways for LAN / WLAN / Internet access
- Widest range of networking options, protocols and standards, frequencies, and technologies in the industry to find the best match for your solution

Original equipment manufacturers (OEMs), systems integrators, service providers, and end-users look to RFM Integration Solutions to address a broad range of machine-to-machine (M2M) challenges including wireless sensor networking, condition-based monitoring / maintenance, and more.

Call RFM (678-684-2000) to discuss your unique custom needs or visit our web site for RFM Integration Solutions case studies.

www.RFM.com



Delivering M2M Around the World

RFM is delivering M2M solutions that help customers connect to and communicate with anyone and anything around the world.

RFM embedded and standalone products enable machine-to-machine (M2M) connectivity and device intelligence for a broad range of industries and applications. Original equipment manufacturers (OEMs) rely on RFM products to simplify and speed-up their communications design process.

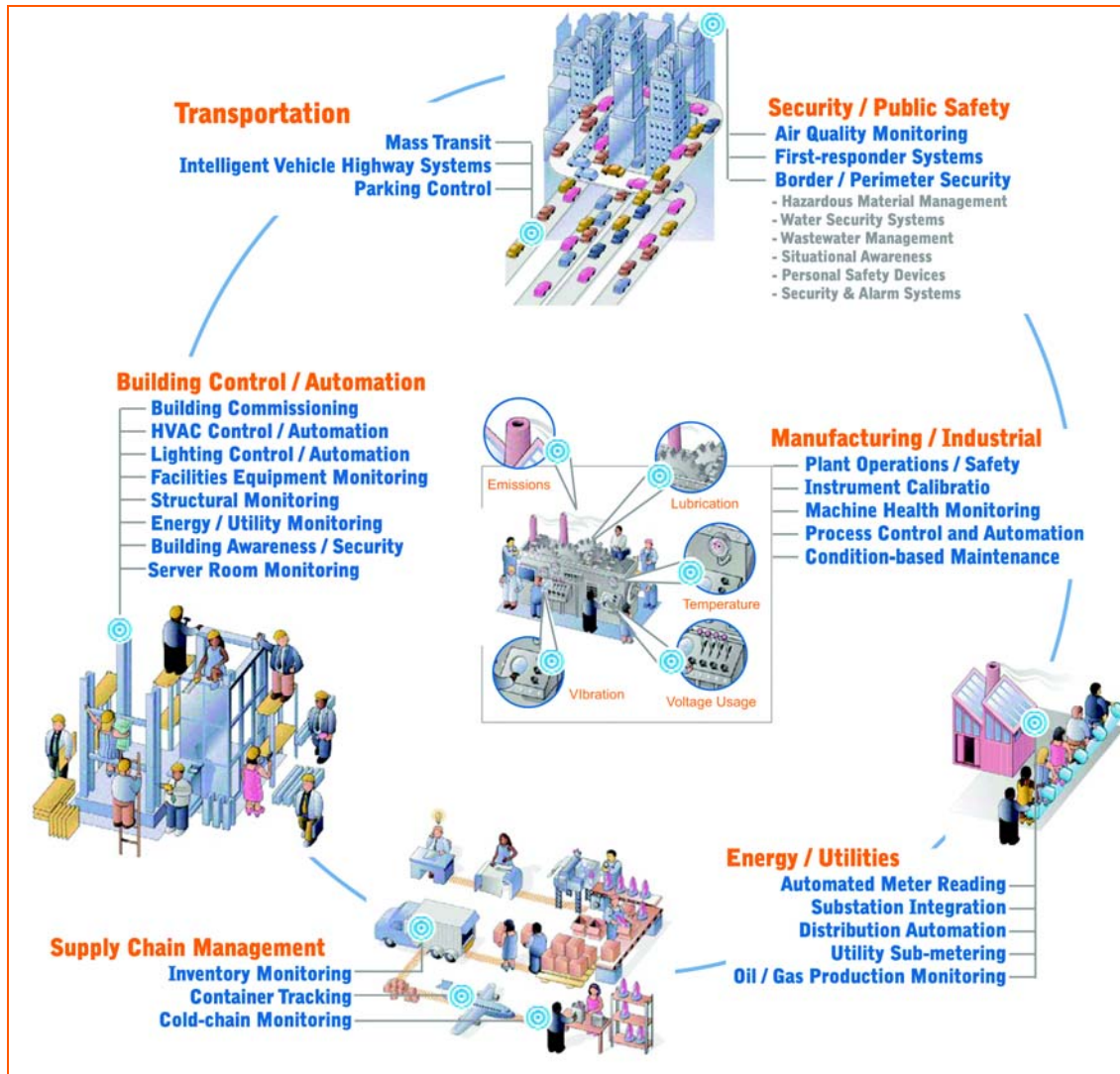

RF Components – High performance wireless components integral to enabling wireless connections and communications; embedded into a wide range of applications

Short-Range Radios – Ultra-low-power transmitters, transceivers and receivers; embedded into a wide range of battery-powered devices

Ready-Made RF Modules and Standalone RF Devices – FCC-certified ready-made transceiver modules embedded into commercial, industrial, and consumer applications; FCC-certified standalone devices that complement the ready-made RF modules to provide end-to-end networking capability for non-embedded solutions

Information about RFM Aleier Asset Management Solutions for condition-based monitoring and condition-based maintenance applications can be found at http://www.rfm.com/software/services_connectivity.shtml. RFM Aleier Asset Management solutions include EAM / CMMS software (enterprise asset management / computerized maintenance management systems), asset management services, and EAM / CMMS best practices consulting.

Make Your Own Wireless Connections

Using RFM RF Components and Subsystem Products

RF Components

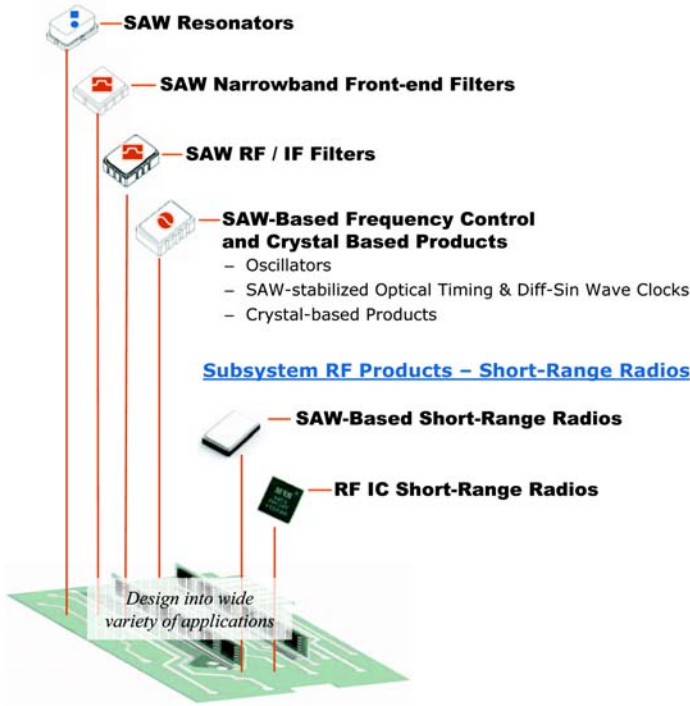

RF Components

High performance wireless components integral to enabling wireless connections and communications; embedded into a wide-range of products.

- 6 MHz – 2.6 GHz
- Variety of small size packages (3.0mm X 3.0mm to 19.0mm X 5.4mm)
- Low cost
- Low-power consumption
- Demo boards and product samples available upon request

Subsystem RF Products – Short-Range Radios

Attractive to OEMs for embedding RF capabilities within their products; field-proven for a wide range of “watch-size” applications needing ultra-low-power consumption

- 300-1000 MHz
- Data rates up to 1Mbps
- SAW & Crystal-based
- OOK/ASK & FSK Modulation
- DSSS and FHSS

Embed or Drop-in Wireless Connections

Using RFM Ready-Made RF Modules and Standalone Devices

Ready-Made RF Modules

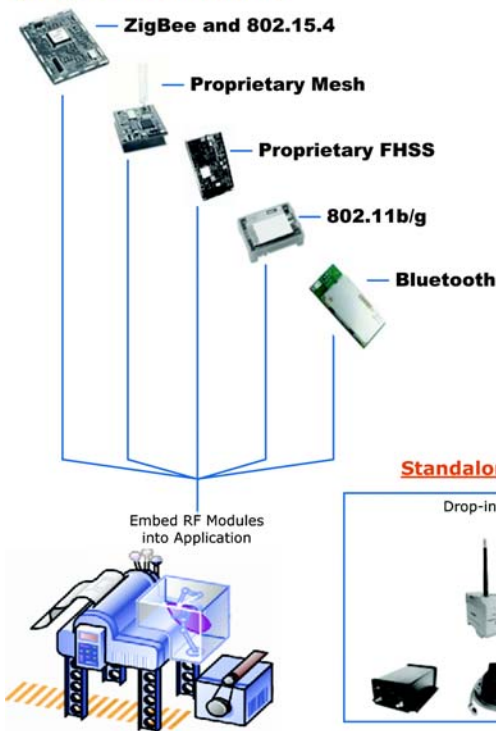

Ready-Made RF Modules

RF modules attractive to OEMs for embedding RF capabilities and communications within their products

Standalone RF Devices

Complementary to Ready-Made RF Modules, these products create end-to-end network applications or enable wireless network integration to existing infrastructure

- Broad range of open AND proprietary standards
- 434 MHz / 900 MHz / 2.4 GHz
- Low-power: 1mW to 1W RF transmit power
- Point-to-point, multipoint (star) and mesh topologies
- FHSS and DSSS
- Wireless sensor mesh networking with data rates up to 250 Kbps
- Wireless telemetry for industrial networking with data rates up to 1.23 Mbps
- Wireless LAN / WiFi with data rates up to 54 Mbps
- Bluetooth data and audio transmission with rates up to 3 Mbps

Table of Contents

SAW Resonators	2
SAW Narrowband Front-end Filters	6
SAW IF / RF Filters	8
SAW-Based Frequency Control Products and Crystal-Based Products	15

SAW-Based Short-Range Radios	19
------------------------------------	----

- New 3rd Generation DR7003**
- Integrated RF IC with quartz SAW filtering and frequency control components in a single hybrid
 - Based on RFM proprietary ASH technology
 - No external RF filters, IF filters, resonators or crystals required
 - Rugged, self-shielding, metal-ceramic hybrid package

RF IC Short-Range Radios	20
--------------------------------	----

- New TRC104**
- Integrated PPL, IF, Baseband circuitry that minimizes external component count
 - Very few external components required
 - Small-size plastic packages

Ready-Made RF Modules and Standalone Devices (formerly marketed under the Cirronet brand)

- New Single-Chip ZigBee**
- **ZigBee ZMN-series and 802.15.4 LPR-series:** 2.4 GHz, low cost, low-power modules PLUS complementary wireless modems and gateways for self-healing mesh, point-to-point, or multipoint sensor networks 25

- **Proprietary mesh DM18- and DM22-series:** 434 MHz / 900 MHz low cost, ultra-low-power modules for self-healing mesh sensor or low-data networking 27

- New XDM2140**
- **Wireless Mesh OEM RF Modules:** 2.4GHz modules designed to provide excellent communications reliability and long battery life in a wide range of sensor network applications 28

- **Proprietary FHSS WIT-series:** 900MHz / 2.4GHz modules PLUS modems, access points, I/O modems, Ethernet bridges for point-to-point or multipoint high-data networking and long-range SCADA or actuation and control 29

- **802.11b/g by Airborne:** 2.4 GHz modules PLUS Ethernet modems and access servers for point-to-point or multi-point LAN or high-data networking 34

- New WT32**
- **Bluetooth by BlueGiga:** 2.4 GHz modules PLUS Ethernet modems and access servers for point-to-point or multi-point audio or data networking 35

Components

SAW-based Components and Frequency Control

SAW Components and Frequency Control

High performance wireless components integral to enabling wireless connections and communications; embedded into a wide range of products.



Products

- SAW Resonators
- SAW Narrowband Filters
- SAW RF & IF Filters
- High performance Frequency Control
 - Oscillators
 - SAW-stabilized Optical Timing and Diff-Sine Wave Clocks
 - Crystal-based Products

Features

- 6 MHz – 2.6 GHz
- Small Size
- Low Cost
- Low Power Consumption

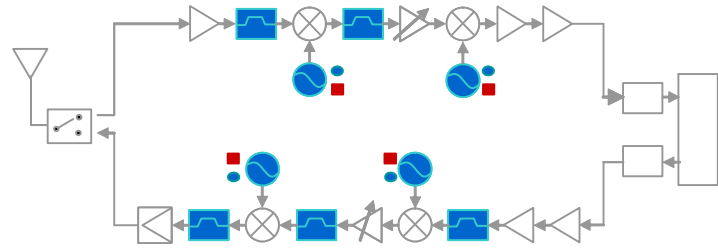

SAW Resonators Low-power SAW resonators are used as frequency control elements in transmitter and receiver LO circuits. These components are essential to the miniature radio frequency transmitters and receivers that enable a variety of wireless consumer, automotive, industrial, medical and commercial applications. RFM manufactures reliable, high performance, low-cost components in a variety of small surface-mount packages as well as the traditional TO-39 "metal can" package.

SAW Narrowband Filters The use of narrowband SAW filters has become a necessity in a variety of wireless links. RFM SAW coupled resonators filter components are used as narrowband front-end filters for receivers to reject strong out of band signals. RFM has an extensive offering of low-cost, rugged, narrowband SAW front-end filters in a broad range of frequencies and a variety of small packages. These low-cost front-end filters exhibit excellent rejection characteristics, low insertion loss and superior temperature stability.

SAW RF/IF Filters RFM filter products includes a variety of standard and custom bandpass filters for radio frequency (RF), intermediate frequency (IF) and other applications. The operating frequencies of these filters range from 40 MHz to 2.6 GHz. These filters are available in a variety of leaded and surface-mount packages. RFM also custom designs and manufactures SAW delay lines and notch filters.

Frequency Control RFM Frequency Control products include a broad array of devices:

- SAW-stabilized Optical Timing Clocks and Diff-Sine Wave Clocks and Oscillators in a wide range of operating frequencies between 200 MHz and 1.8 GHz. They have tolerances of 100 ppm basic stability or the ability to tune to lock to a more stable system clock.
- A variety of tiny, high performance Crystal-based devices used in both time and frequency domain applications.

SAW Resonators

RFM provides a large selection of discrete SAW resonators in a broad range of frequencies from 300 MHz to over 1 GHz. These products are designed to be the frequency control element in transmitters and receiver local oscillators. Their use allows reduced receiver bandwidths, which results in improved sensitivity and immunity to interference. Tighter center frequency tolerances are becoming popular primarily in Europe. RFM can provide as tight as ± 50 kHz currently. These devices are quartz stabilized to ensure maximum temperature performance in a variety of applications.

Port Types

The SAW Resonator product family includes one and two-port types. The RO series is a line of true one-port devices with a lumped element model that is similar to that of a bulk crystal device. One-port resonators are typically used in modified Colpitts oscillator configurations where the resonator is connected between the base of a transistor and ground.

Packaging

RO resonator products are packaged in both the traditional TO39 and a variety of surface-mount packages. The TO39 parts are shipped in antistatic shipping tubes and the SMT parts are shipped in tape-and-reel. RFM is currently manufacturing both the TO39 and SMT versions of one-port resonators in high volumes.

Applications



- Automotive keyless entry
- Tire pressure monitoring
- GPS locating systems



- Wireless point-of-sale terminals
- Data link equipment
- Peripherals
- High Performance Computing (HPC)

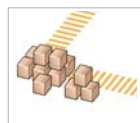

- Remote bar code data entry
- Bar code readers
- Identification tags



- Home automation
- Door and gate openers
- Personal and home security
- Automated meter reading
- Consumer sports

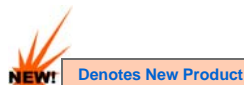

SAW Resonators			Select by Part Number	
Product No.	Replacement	Freq. (MHz)	Lid Sym.	Case
RO2023-10	RO3023	433.97	202310	TO39-3
RO2043		303.875	RO2043	TO39-3
RO2044		318	RO2044	TO39-3
RO2053A-1	RO3053A-1	310	308	SM-2
RO2073	RO3073	315	RO2073	TO39-3
RO2073A	RO3073A	315	101	SM-2
RO2073A-1	RO3073A-1	315	111	SM-2
RO2073A-17	RO3073A	315	505	SM-2
RO2073A-5	RO3073A-5	315.05	151	SM-2
RO2073A-6	RO3073A-1	315	164	SM-2
RO2073C	RO3073C	315	412	SM5050-8
RO2073D	RO3073D	315	442	SM3838-6
RO2073E	RO3073E	315	474	SM3030-6
RO2073E-2	RO3073E-1	315	527	SM3030-6
RO2100		295.05	RO2100	TO39-3
RO2101	RO3101	433.92	RO2101	TO39-3
RO2101A	RO3101A	433.92	100	SM-2
RO2101A-10	RO3101A	433.92	277	SM-2
RO2101A-12	RO3101A-1	433.92	307	SM-2
RO2101A-15	RO3101A	433.92	480	SM-2
RO2101A-17	RO3101A	433.92	573	SM-2
RO2101A-6	RO3101A-1	433.92	159	SM-2
RO2101C	RO3101C	433.92	411	SM5050-8
RO2101D	RO3101D	433.92	439	SM3838-6
RO2101E	RO3101E	433.92	475	SM3030-6
RO2101E-2	RO3101E-1	433.92	552	SM3030-6
RO2102	RO3102	423.22	RO2102	TO39-3
RO2102A	RO3102A	423.22	114	SM-2
RO2102A-1	RO3102A-1	423.22	146	SM-2
RO2103	RO3103	418	RO2103	TO39-3
RO2103A	RO3103A	418	106	SM-2
RO2103E	RO3103E	418	631	SM3030-6
RO2104	RO3104	303.825	RO2104	TO39-3
RO2104A	RO3104A	303.825	112	SM-2
RO2104D	RO3104D	303.825	486	SM3838-6
RO2104D-2	RO3104D	303.825	632	SM3838-6
RO2104E	RO3104E	303.825	543	SM3030-6
RO2112	RO3112	433.42	RO2112	TO39-3
RO2112A	RO3112A	433.42	102	SM-2
RO2112A-17	RO3112A	433.42	587	SM-2
RO2112C	RO3112C	433.42	438	SM5050-8
RO2112D	RO3112D	433.42	467	SM3838-6
RO2112E	RO3112E	433.42	526	SM3030-6
RO2113	RO3113	314.5	RO2113	TO39-3
RO2113A	RO3113A	314.5	103	SM-2
RO2115	RO3115	417.5	RO2115	TO39-3
RO2115A	RO3115A	417.5	104	SM-2
RO2116	RO3116	303.325	RO2116	TO39-3
RO2116A	RO3116A	303.325	105	SM-2
RO2118A	RO3118A	318	108	SM-2
RO2119A	RO3119A	317.5	109	SM-2
RO2120A	RO3120A	403.55	110	SM-2
RO2122A	RO3122A	293.125	116	SM-2
RO2123A	RO3123A	307.3	117	SM-2
RO2125A	RO3125A	304.3	121	SM-2
RO2125A-5	RO3125A-2	304.3	184	SM-2
RO2131D		314.35	440	SM3838-6
RO2134A	RO3134A	372.5	131	SM-2
RO2138A	RO3138A	407.3	144	SM-2
RO2144A	RO3144A-2	916.5	158	SM-2
RO2144A-1	RO3144A	916.5	298	SM-2
RO2144A-2	RO3144A-1	916.5	408	SM-2

SAW Resonators

RO2144D	RO3144D-2	916.5	432	SM3838-6
RO2144D-1	RO3144D	916.5	493	SM3838-6
RO2144D-2	RO3144D-1	916.5	537	SM3838-6
RO2144E	RO3144E	916.5	515	SM3030-6
RO2144E-1	RO3144E-1	916.5	604	SM3030-6
RO2144E-2	RO3144E-2	916.5	605	SM3030-6
RO2156A	RO3156A-3	868.95	197	SM-2
RO2156A-1	RO3156A	868.95	280	SM-2
RO2156A-2	RO3156A-2	868.95	407	SM-2
RO2156D	RO3156D	868.95	433	SM3838-6
RO2156D-1	RO3156D	868.95	614	SM3838-6
RO2156D-2	RO3156D	868.95	615	SM3838-6
RO2156E	RO3156E-1	868.95	562	SM3030-6
RO2156E-1	RO3156E-2	868.95	562	SM3030-6
RO2156E-2	RO3156E-2	868.95	562	SM3030-6
RO2164A	RO3164A-3	868.35	260	SM-2
RO2164A-1	RO3164A-1	868.35	278	SM-2
RO2164A-2	RO3164A-2	868.35	404	SM-2
RO2164D	RO3164D	868.35	434	SM3838-6
RO2164D-1	RO3164D-1	868.35	556	SM3838-6
RO2164D-2	RO3164D-2	868.35	613	SM3838-6
RO2164E	RO3164E-1	868.35	516	SM3030-6
RO2164E-1	RO3164E-2	868.35	558	SM3030-6
RO2164E-2	RO3164E-2	868.35	559	SM3030-6
RO2188A	RO3188A	390	319	SM-2
RO2193A	RO3193A	379.3	397	SM-2
RO3023		433.97	RO3023	TO39-3
RO3030A-1		314.2	830	SM5035-4
RO3053A-1		310	810	SM5035-4
RO3073		315	RO3073	TO39-3
RO3073A		315	656	SM5035-4
RO3073A-1		315	742	SM5035-4
RO3073A-5		315.05	788	SM5035-4
RO3073A-6		315	789	SM5035-4
RO3073C		315	706	SM5050-8
RO3073D		315	705	SM3838-6
RO3073E		315	704	SM3030-6
RO3073E-1		315	802	SM3030-6
RO3075		345	RO3075	TO39-3
RO3075A		345	664	SM5035-4
RO3075E		345	694	SM3030-6
RO3101		433.92	RO3101	TO39-3
RO3101A		433.92	655	SM5035-4
RO3101A-1		433.92	745	SM5035-4
RO3101C		433.92	703	SM5050-8
RO3101D		433.92	702	SM3838-6
RO3101E		433.92	701	SM3030-6
RO3101E-1		433.92	750	SM3030-6
RO3102		423.22	RO3102	TO39-3
RO3102A		423.22	823	SM5035-4
RO3102A-1		423.22	784	SM5035-4
RO3103		418	RO3103	TO39-3
RO3103A		418	659	SM5035-4
RO3103D		418	717	SM3838-6
RO3103E		418	676	SM3030-6
RO3104		303.825	RO3104	TO39-3
RO3104A		303.825	662	SM5035-4
RO3104C		303.825	688	SM5050-8
RO3104D		303.825	689	SM3838-6
RO3104E		303.825	690	SM3030-6
RO3112		433.42	RO3112	TO39-3
RO3112A		433.42	658	SM5035-4
RO3112C		433.42	657	SM5050-8

RO3112D		433.42	683	SM3838-6
RO3112E		433.42	684	SM3030-6
RO3113		314.5	RO3113	TO39-3
RO3113A		314.5	801	SM5035-4
RO3115		417.5	RO3115	TO39-3
RO3115A		417.5	833	SM5035-4
RO3116		303.325	RO3116	TO39-3
RO3116A		303.325	819	SM5035-4
RO3118		318	RO3118	TO39-3
RO3118A		318	661	SM5035-4
RO3118D		318	716	SM3838-6
RO3118E		318	687	SM3030-6
RO3119A		317.5	834	SM5035-4
RO3120A		403.55	824	SM5035-4
RO3122A		293.125	835	SM5035-4
RO3123A		307.3	831	SM5035-4
RO3125A		304.3	787	SM5035-4
RO3125A-2		304.3	815	SM5035-4
RO3132A		312	794	SM5035-4
RO3134A		372.5	836	SM5035-4
RO3138A		407.3	837	SM5035-4
RO3143A		372	820	SM5035-4
RO3144		916.5	RO3144	TO39-3
RO3144A		916.5	663	SM5050-8
RO3144A-1		916.5	663	SM5050-8
RO3144A-2		916.5	663	SM5050-8
RO3144C		916.5	691	SM5050-8
RO3144D		916.5	692	SM3838-6
RO3144D-1		916.5	692	SM3838-6
RO3144D-2		916.5	692	SM3838-6
RO3144E		916.5	693	SM3030-6
RO3144E-1		916.5	693	SM3030-6
RO3144E-2		916.5	693	SM3030-6
RO3156A		868.95	714	SM5035-4
RO3156A-1		868.95	714	SM5035-4
RO3156A-2		868.95	714	SM5035-4
RO3156A-3		868.95	808	SM5035-4
RO3156D		868.95	715	SM3838-6
RO3156D-1		868.95	715	SM3838-6
RO3156D-2		868.95	715	SM3838-6
RO3156E		868.95	707	SM3030-6
RO3156E-1		868.95	707	SM3030-6
RO3156E-2		868.95	707	SM3030-6
RO3164		868.35	RO3164	TO39-3
RO3164A-1		868.35	660	SM5035-4
RO3164A-2		868.35	660	SM5035-4
RO3164A-3		868.35	814	SM5035-4
RO3164A		868.35	660	SM5035-4
RO3164C		868.35	799	SM5050-8
RO3164D		868.35	685	SM3838-6
RO3164D-1		868.35	685	SM3838-6
RO3164D-2		868.35	685	SM3838-6
RO3164E		868.35	686	SM3030-6
RO3164E-1		868.35	686	SM3030-6
RO3164E-2		868.35	686	SM3030-6
RO3188A		390	797	SM5035-4
RO3193A		379.3	832	SM5035-4
RO3300E		403.55	719	SM3030-6



Denotes New Product

SAW Resonators

SAW Resonators			Select by Part Number	
Product No.	Replacement	Freq. (MHz)	Lid Sym.	Case
RO2122A	RO3122A	293.125	116	SM-2
RO3122A		293.125	835	SM5035-4
RO2100		295.05	RO2100	TO39-3
RO2116	RO3116	303.325	RO2116	TO39-3
RO2116A	RO3116A	303.325	105	SM-2
RO3116		303.325	RO3116	TO39-3
RO3116A		303.325	819	SM5035-4
RO2104	RO3104	303.825	RO2104	TO39-3
RO2104A	RO3104A	303.825	112	SM-2
RO2104D	RO3104D	303.825	486	SM3838-6
RO2104D-2	RO3104D	303.825	632	SM3838-6
RO2104E	RO3104E	303.825	543	SM3030-6
RO3104		303.825	RO3104	TO39-3
RO3104A		303.825	662	SM5035-4
RO3104C		303.825	688	SM5050-8
RO3104D		303.825	689	SM3838-6
RO3104E		303.825	690	SM3030-6
RO2043		303.875	RO2043	TO39-3
RO3150A		304	838	SM5035-4
RO2125A	RO3125A	304.3	121	SM-2
RO2125A-5	RO3125A-2	304.3	184	SM-2
RO3125A		304.3	787	SM5035-4
RO3125A-2		304.3	815	SM5035-4
RO2123A	RO3123A	307.3	117	SM-2
RO3123A		307.3	831	SM5035-4
RO2053A-1	RO3053A-1	310	308	SM-2
RO3053A-1		310	810	SM5035-4
RO3132A		312	794	SM5035-4
RO3030A-1		314.2	830	SM5035-4
RO2131D		314.35	440	SM3838-6
RO2113	RO3113	314.5	RO2113	TO39-3
RO2113A	RO3113A	314.5	103	SM-2
RO3113		314.5	RO3113	TO39-3
RO3113A		314.5	801	SM5035-4
RO2073	RO3073	315	RO2073	TO39-3
RO2073A	RO3073A	315	101	SM-2
RO2073A-1	RO3073A-1	315	111	SM-2
RO2073A-17	RO3073A	315	505	SM-2
RO2073A-6	RO3073A-1	315	164	SM-2
RO2073C	RO3073C	315	412	SM5050-8
RO2073D	RO3073D	315	442	SM3838-6
RO2073E	RO3073E	315	474	SM3030-6
RO2073E-2	RO3073E-1	315	527	SM3030-6
RO3073		315	RO3073	TO39-3
RO3073A		315	656	SM5035-4
RO3073A-1		315	742	SM5035-4
RO3073A-6		315	789	SM5035-4
RO3073C		315	706	SM5050-8
RO3073D		315	705	SM3838-6
RO3073E		315	704	SM3030-6
RO3073E-1		315	802	SM3030-6
RO2073A-5	RO3073A-5	315.05	151	SM-2
RO3073A-5		315.05	788	SM5035-4
RO2119A	RO3119A	317.5	109	SM-2
RO3119A		317.5	834	SM5035-4
RO2044		318	RO2044	TO39-3
RO2118A	RO3118A	318	108	SM-2
RO3118		318	RO3118	TO39-3
RO3118A		318	661	SM5035-4
RO3118D		318	716	SM3838-6
RO3118E		318	687	SM3030-6
RO3075		345	RO3075	TO39-3
RO3075A		345	664	SM5035-4
RO3075E		345	694	SM3030-6

RO3143A		372	820	SM5035-4
RO2134A	RO3134A	372.5	131	SM-2
RO3134A		372.5	836	SM5035-4
RO2193A	RO3193A	379.3	397	SM-2
RO3193A		379.3	832	SM5035-4
RO2188A	RO3188A	390	319	SM-2
RO3188A		390	797	SM5035-4
RO2120A	RO3120A	403.55	110	SM-2
RO3120A		403.55	824	SM5035-4
RO3300E		403.55	719	SM3030-6
RO2138A	RO3138A	407.3	144	SM-2
RO3138A		407.3	837	SM5035-4
RO2115	RO3115	417.5	RO2115	TO39-3
RO2115A	RO3115A	417.5	104	SM-2
RO3115		417.5	RO3115	TO39-3
RO3115A		417.5	833	SM5035-4
RO2109	RO3103	418	RO2103	TO39-3
RO2103A	RO3103A	418	106	SM-2
RO2103E	RO3103E	418	631	SM3030-6
RO3103		418	RO3103	TO39-3
RO3103A		418	659	SM5035-4
RO3103D		418	717	SM3838-6
RO3103E		418	676	SM3030-6
RO2102	RO3102	423.22	RO2102	TO39-3
RO2102A	RO3102A	423.22	114	SM-2
RO2102A-1	RO3102A-1	423.22	146	SM-2
RO3102		423.22	RO3102	TO39-3
RO3102A		423.22	823	SM5035-4
RO3102A-1		423.22	784	SM5035-4
RO2112	RO3112	433.42	RO2112	TO39-3
RO2112A	RO3112A	433.42	102	SM-2
RO2112A-17	RO3112A	433.42	587	SM-2
RO2112C	RO3112C	433.42	438	SM5050-8
RO2112D	RO3112D	433.42	467	SM3838-6
RO2112E	RO3112E	433.42	526	SM3030-6
RO3112		433.42	RO3112	TO39-3
RO3112A		433.42	658	SM5035-4
RO3112C		433.42	657	SM5050-8
RO3112D		433.42	683	SM3838-6
RO3112E		433.42	684	SM3030-6
RO2101	RO3101	433.92	RO2101	TO39-3
RO2101A	RO3101A	433.92	100	SM-2
RO2101A-10	RO3101A	433.92	277	SM-2
RO2101A-12	RO3101A-1	433.92	307	SM-2
RO2101A-15	RO3101A	433.92	480	SM-2
RO2101A-17	RO3101A	433.92	573	SM-2
RO2101A-6	RO3101A-1	433.92	159	SM-2
RO2101C	RO3101C	433.92	411	SM5050-8
RO2101D	RO3101D	433.92	439	SM3838-6
RO2101E	RO3101E	433.92	475	SM3030-6
RO2101E-2	RO3101E-1	433.92	552	SM3030-6
RO3101		433.92	RO3101	TO39-3
RO3101A		433.92	655	SM5035-4
RO3101A-1		433.92	745	SM5035-4
RO3101C		433.92	703	SM5050-8
RO3101D		433.92	702	SM3838-6
RO3101E		433.92	701	SM3030-6
RO3101E-1		433.92	750	SM3030-6
RO2023-10	RO3023	433.97	202310	TO39-3
RO3023		433.97	RO3023	TO39-3
RO2164A	RO3164A-3	868.35	260	SM-2
RO2164A-1	RO3164A-1	868.35	278	SM-2
RO2164A-2	RO3164A-2	868.35	404	SM-2
RO2164D	RO3164D	868.35	434	SM3838-6
RO2164D-1	RO3164D-1	868.35	556	SM3838-6
RO2164D-2	RO3164D-2	868.35	613	SM3838-6

SAW Resonators

RO2164E	RO3164E-1	868.35	516	SM3030-6
RO2164E-1	RO3164E-2	868.35	558	SM3030-6
RO2164E-2	RO3164E-2	868.35	559	SM3030-6
RO3164		868.35	RO3164	TO39-3
RO3164A-1		868.35	660	SM5035-4
RO3164A-2		868.35	660	SM5035-4
RO3164A-3		868.35	814	SM5035-4
RO3164A		868.35	660	SM5035-4
RO3164C		868.35	799	SM5050-8
RO3164D		868.35	685	SM3838-6
RO3164D-1		868.35	685	SM3838-6
RO3164D-2		868.35	685	SM3838-6
RO3164E		868.35	686	SM3030-6
RO3164E-1		868.35	686	SM3030-6
RO3164E-2		868.35	686	SM3030-6
RO2156A	RO3156A-3	868.95	197	SM-2
RO2156A-1	RO3156A	868.95	280	SM-2
RO2156A-2	RO3156A-2	868.95	407	SM-2
RO2156D	RO3156D	868.95	433	SM3838-6
RO2156D-1	RO3156D	868.95	614	SM3838-6
RO2156D-2	RO3156D	868.95	615	SM3838-6
RO2156E	RO3156E-1	868.95	562	SM3030-6
RO2156E-1	RO3156E-2	868.95	562	SM3030-6
RO2156E-2	RO3156E-2	868.95	562	SM3030-6
RO3156A		868.95	714	SM5035-4
RO3156A-1		868.95	714	SM5035-4
RO3156A-2		868.95	714	SM5035-4
RO3156A-3		868.95	808	SM5035-4
RO3156D		868.95	715	SM3838-6
RO3156D-1		868.95	715	SM3838-6
RO3156D-2		868.95	715	SM3838-6
RO3156E		868.95	707	SM3030-6
RO3156E-1		868.95	707	SM3030-6
RO3156E-2		868.95	707	SM3030-6
RO2144A	RO3144A-2	916.5	158	SM-2
RO2144A-1	RO3144A	916.5	298	SM-2
RO2144A-2	RO3144A-1	916.5	408	SM-2
RO2144D	RO3144D-2	916.5	432	SM3838-6
RO2144D-1	RO3144D	916.5	493	SM3838-6
RO2144D-2	RO3144D-1	916.5	537	SM3838-6
RO2144E	RO3144E	916.5	515	SM3030-6
RO2144E-1	RO3144E-1	916.5	604	SM3030-6
RO2144E-2	RO3144E-2	916.5	605	SM3030-6
RO3144		916.5	RO3144	TO39-3
RO3144A		916.5	663	SM5050-8
RO3144A-1		916.5	663	SM5050-8
RO3144A-2		916.5	663	SM5050-8
RO3144C		916.5	691	SM5050-8
RO3144D		916.5	692	SM3838-6
RO3144D-1		916.5	692	SM3838-6
RO3144D-2		916.5	692	SM3838-6
RO3144E		916.5	693	SM3030-6
RO3144E-1		916.5	693	SM3030-6
RO3144E-2		916.5	693	SM3030-6

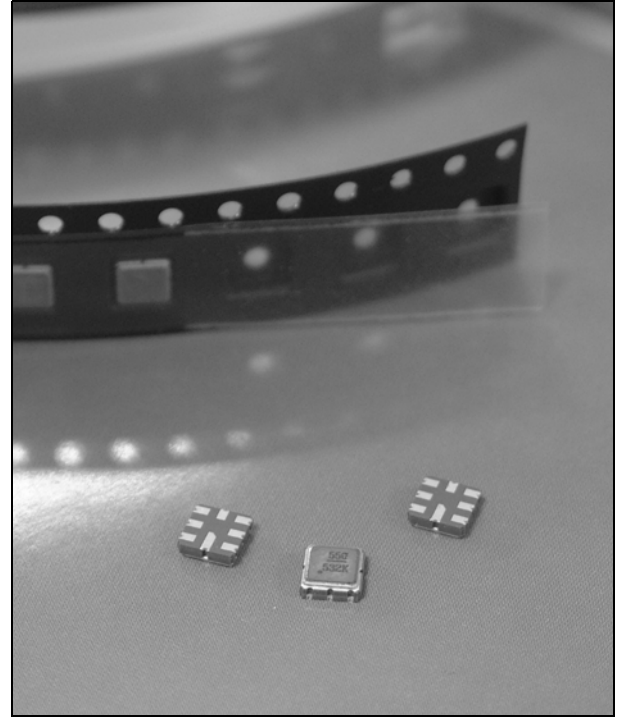

SAW Narrowband Front End Filters

RFM provides a large selection of low-loss narrowband front end filters for all major frequencies used in low-power unlicensed communications equipment ranging from 300-1000 MHz. Coupled-resonator filter technology is used in the RF series of components. These devices are used as narrowband front-end filters to reject strong out-of-band signals.

Typical bandwidths are 600-900 kHz with typical ultimate out-of-band rejection of 50 dB. Special rejection is provided at key points such as -10.7 MHz for local oscillator rejection and -21.4 MHz for the image spurious response in typical superhet receivers.

Optimum implementation of this filter technology is accomplished when the filter is matched on both input and output ports. This matching is typically a simple inductor-capacitor network. In addition to matching, careful attention to circuit board layout is also important to achieve optimum filter performance.

Applications



- Automotive keyless entry
- Tire pressure monitoring
- GPS locating systems



- Wireless point-of-sale terminals
- Data link equipment
- Peripherals
- High Performance Computing (HPC)

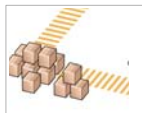

- Remote bar code data entry
- Bar code readers
- Identification tags



- Home automation
- Door and gate openers
- Personal and home security
- Automated meter reading
- Consumer sports

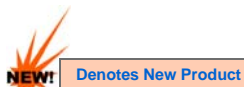
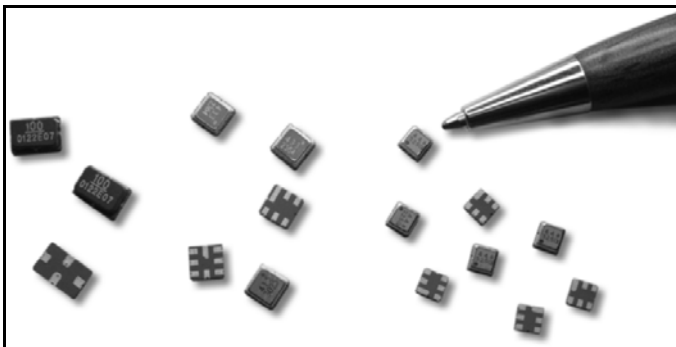

Narrowband Front End Filters			Select by Part	
Product No.	New Product	Freq. (MHz)	Bandwidth (kHz)	Case mmxmm
RF1171	RF3171	418	600	TO39-3
RF1171D	RF3171D	418	620	3.8x3.8
RF1172	RF3404	433.92	600	TO39-3
RF1172C		433.92	700	5.0x5.0
RF1172D	RF3404D	433.92	600	3.8x3.8
RF1181	RF3181	916.5	750	TO39-3
RF1181D	RF3181D	916.5	600	3.8x3.8
RF1181E	RF3181E	916.5	600	3.0x3.0
RF1210		303.825	700	TO39-3
RF1210D	RF3210D	303.825	650	3.8x3.8
RF1211	RF3417	315	700	TO39-3
RF1211C		315	900	5.0x5.0
RF1211D		315	600	3.8x3.8
RF1238		318	700	TO39-3
RF1284		319.5	600	TO39-3
RF1295C		451.35	1000	5.0x5.0
RF1319D	RF3319D	868.95	650	3.8x3.8
RF1319E	RF3319E	868.95	900	3.0x3.0
RF1336C	RF3336C	868.35	600	5.0x5.0
RF1336D	RF3336D	868.35	650	3.8x3.8
RF1336E	RF3336E	868.35	650	3.0x3.0
RF1353C		345	430	5.0x5.0
RF1353D		345	430	3.8x3.8
RF1355		390	440	TO39-3
RF1391C		433.42	600	5.0x5.0
RF1396C		433.42	700	5.0x5.0
RF1400D		433.92	1150	3.8x3.8
RF1401D		433.92	1000	3.8x3.8
RF1402D		315	1000	3.8x3.8
RF1404C		433.92	700	5.0x5.0
RF1404E	RF3404E	433.92	650	3.0x3.0
RF1407D		868.6	1800	3.8x3.8
RF1408D		447.7	840	3.8x3.8
RF1411D		869.2625	1250	3.8x3.8
RF1414D		372.5	450	3.8x3.8
RF1417E	RF3417E	315	600	3.0x3.0
RF1419D		403.5	7500	3.8x3.8
RF1432C		319.5	600	5.0x5.0
RF3171		418	600	TO39-3
RF3171D		418	620	3.8x3.8
RF3181		916.5	750	TO39-3
RF3181D		916.5	600	3.8x3.8
RF3181E		916.5	600	3.0x3.0
RF3210D		303.825	650	3.8x3.8
RF3319D		868.95	650	3.8x3.8
RF3336		868.35	600	TO39-3
RF3336C		868.35	600	5.0x5.0
RF3336D		868.35	650	3.8x3.8
RF3336E		868.35	650	3.0x3.0
RF3355C		390	440	5.0x5.0
RF3404		433.92	600	TO39-3
RF3404D		433.92	600	3.8x3.8
RF3404E		433.92	650	3.0x3.0
RF3414E		372.5	450	3.0x3.0
RF3417		315	700	TO39-3
RF3417D		315	600	3.8x3.8
RF3417E		315	600	3.0x3.0
RF3501E		866.1	31000	3.0x3.0
RF3601E		960	40000	3.0x3.0

SAW Narrowband Front End Filters

Narrowband Front End Filters			Select by Frequency	
Product No.	New Product	Freq. (MHz)	Bandwidth (kHz)	Case mmxmm
RF1210		303.825	700	TO39-3
RF1210D	RF3210D	303.825	650	3.8x3.8
RF3210D		303.825	650	3.8x3.8
RF1211	RF3417	315	700	TO39-3
RF1211C		315	900	5.0x5.0
RF1211D		315	600	3.8x3.8
RF1402D		315	1000	3.8x3.8
RF1417E	RF3417E	315	600	3.0x3.0
RF3417		315	700	TO39-3
RF3417D		315	600	3.8x3.8
RF3417E		315	600	3.0x3.0
RF1238		318	700	TO39-3
RF1284		319.5	600	TO39-3
RF1432C		319.5	600	5.0x5.0
RF1353C		345	430	5.0x5.0
RF1353D		345	430	3.8x3.8
RF1414D		372.5	450	3.8x3.8
RF3414E		372.5	450	3.0x3.0
RF1355		390	440	TO39-3
RF3355C		390	440	5.0x5.0
RF1419D		403.5	7500	3.8x3.8
RF1171	RF3171	418	600	TO39-3
RF1171D	RF3171D	418	620	3.8x3.8
RF3171		418	600	TO39-3
RF3171D		418	620	3.8x3.8
RF1391C		433.42	600	5.0x5.0
RF1396C		433.42	700	5.0x5.0
RF1172	RF3404	433.92	600	TO39-3
RF1172C		433.92	700	5.0x5.0
RF1172D	RF3404D	433.92	600	3.8x3.8
RF1400D		433.92	1150	3.8x3.8
RF1401D		433.92	1000	3.8x3.8
RF1404C		433.92	700	5.0x5.0
RF1404E	RF3404E	433.92	650	3.0x3.0
RF3404		433.92	600	TO39-3
RF3404D		433.92	600	3.8x3.8
RF3404E		433.92	650	3.0x3.0
RF1408D		447.7	840	3.8x3.8
RF1295C		451.35	1000	5.0x5.0
RF3501E		866.1	31000	3.0x3.0
RF1336C	RF3336C	868.35	600	5.0x5.0
RF1336D	RF3336D	868.35	650	3.8x3.8
RF1336E	RF3336E	868.35	650	3.0x3.0
RF3336		868.35	600	TO39-3
RF3336C		868.35	600	5.0x5.0
RF3336D		868.35	650	3.8x3.8
RF3336E		868.35	650	3.0x3.0
RF1407D		868.6	1800	3.8x3.8
RF1319D	RF3319D	868.95	650	3.8x3.8
RF1319E	RF3319E	868.95	900	3.0x3.0
RF3319D		868.95	650	3.8x3.8
RF1411D		869.2625	1250	3.8x3.8
RF1181	RF3181	916.5	750	TO39-3
RF1181D	RF3181D	916.5	600	3.8x3.8
RF1181E	RF3181E	916.5	600	3.0x3.0
RF3181		916.5	750	TO39-3
RF3181D		916.5	600	3.8x3.8
RF3181E		916.5	600	3.0x3.0
RF3601E		960	40000	3.0x3.0

Narrowband Front End Filters			Select by Bandwidth	
Product No.	New Product	Freq. (MHz)	Bandwidth (kHz)	Case mmxmm
RF1353C		345	430	5.0x5.0
RF1353D		345	430	3.8x3.8
RF1355		390	440	TO39-3
RF3355C		390	440	5.0x5.0
RF1414D		372.5	450	3.8x3.8
RF3414E		372.5	450	3.0x3.0
RF1171	RF3171	418	600	TO39-3
RF1172	RF3404	433.92	600	TO39-3
RF1172D	RF3404D	433.92	600	3.8x3.8
RF1181D	RF3181D	916.5	600	3.8x3.8
RF1181E	RF3181E	916.5	600	3.0x3.0
RF1211D		315	600	3.8x3.8
RF1284		319.5	600	TO39-3
RF1336C	RF3336C	868.35	600	5.0x5.0
RF1391C		433.42	600	5.0x5.0
RF1417E	RF3417E	315	600	3.0x3.0
RF1432C		319.5	600	5.0x5.0
RF3171		418	600	TO39-3
RF3181D		916.5	600	3.8x3.8
RF3181E		916.5	600	3.0x3.0
RF3336		868.35	600	TO39-3
RF3336C		868.35	600	5.0x5.0
RF3404		433.92	600	TO39-3
RF3404D		433.92	600	3.8x3.8
RF3417D		315	600	3.8x3.8
RF3417E		315	600	3.0x3.0
RF1171D	RF3171D	418	620	3.8x3.8
RF3171D		418	620	3.8x3.8
RF1210D	RF3210D	303.825	650	3.8x3.8
RF1319D	RF3319D	868.95	650	3.8x3.8
RF1336D	RF3336D	868.35	650	3.8x3.8
RF1336E	RF3336E	868.35	650	3.0x3.0
RF1404E	RF3404E	433.92	650	3.0x3.0
RF3210D		303.825	650	3.8x3.8
RF3319D		868.95	650	3.8x3.8
RF3336D		868.35	650	3.8x3.8
RF3336E		868.35	650	3.0x3.0
RF3404E		433.92	650	3.0x3.0
RF1172C		433.92	700	5.0x5.0
RF1210		303.825	700	TO39-3
RF1211	RF3417	315	700	TO39-3
RF1238		318	700	TO39-3
RF1396C		433.42	700	5.0x5.0
RF1404C		433.92	700	5.0x5.0
RF3417		315	700	TO39-3
RF1181	RF3181	916.5	750	TO39-3
RF3181		916.5	750	TO39-3
RF1408D		447.7	840	3.8x3.8
RF1211C		315	900	5.0x5.0
RF1319E	RF3319E	868.95	900	3.0x3.0
RF1295C		451.35	1000	5.0x5.0
RF1401D		433.92	1000	3.8x3.8
RF1402D		315	1000	3.8x3.8
RF1400D		433.92	1150	3.8x3.8
RF1411D		869.2625	1250	3.8x3.8
RF1407D		868.6	1800	3.8x3.8
RF1419D		403.5	7500	3.8x3.8
RF3501E		866.1	31000	3.0x3.0
RF3601E		960	40000	3.0x3.0

SAW RF / IF Filters

RFM designs and manufactures bandpass filters, delay lines, and notch filters, for a wide range of wireless telecommunication and data communication applications. We provide filters from 40 MHz to more than 2.6 GHz in surface-mount, dual-in-line (DIP) and TO39 packages. Our filter products offer a wide range of bandwidth, low insertion loss, low amplitude and group delay ripple, small size and high out-of-band rejection.

In addition to our standard product offering, RFM provides custom filter design services for high volume applications that include a variety of Satellite Digital Audio Radio (SDAR) subscriber platforms (Sirius and XM), cellular handsets, base stations, and repeaters (including EDGE, WCDMA, CDMA-2000, TD-SCDMA, GSM900, DCS1800, PCS1900, CDMA, TDMA and AMPs, DECT), global positioning system (GPS), microwave radio, wireless local loop (WLL), wireless local area networks (WLAN), multimedia and fiber-optic transmission equipment.

Applications



- Automotive keyless entry
- Tire pressure monitoring
- GPS locating systems



- Wireless point-of-sale terminals
- Data link equipment
- Peripherals

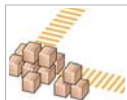

- Remote bar code data entry
- Bar code readers
- Identification tags



- Satellite digital audio radio (SDAR)
- Global positioning systems (GPS)



- Wireless local area network (WLAN)
- CATV Infrastructure
- Synchronous optical network (SONET)
- High Performance Computing (HPC)



- Home automation
- Door and gate openers
- Personal and home security
- Automated meter reading
- Consumer sports



- Cellular Subscriber Terminals, Base Stations, and Repeaters for:
- GSM
 - TDMA
 - CDMA
 - TD-SCDMA
 - W-CDMA
 - Wireless Local Loop
- Cellular Digital Packet Data (CDPD) modems

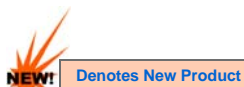

SAW RF / IF Filter				Select by Part Number	
Type	Product No.	Freq. (MHz)	BW (MHz)	Application	Case (mm)
IF Filter	PX1002	86.85	0.024	IS-54 TDMA	13.3x6.5
IF Filter	PX1004	82.2	0.03	IS-54 TDMA	13.3x6.5
RF Filter	RF1199	297.4	0.6	Filter	TO39-3
RF Filter	RF1301	499.25	0.06	Narrowband RF Filter	TO39-3
RF Filter	RF1302	439.25	0.06	Narrowband RF Filter	TO39-3
IF Filter	SF1056A	110.592	1.152	DECT	13.3x6.5
IF Filter	SF1059A	350	0.8	IF Filter	9.1x7.1
IF Filter	SF1081A	71	0.2	GSM/EDGE	22.1x8.0
IF Filter	SF1081A-1	71	0.2	GSM/EDGE	22.1x8.0
IF Filter	SF1088A	170.6	0.18	GSM/EDGE	19x6.5
IF Filter	SF1091A	211	0.9	GSM/EDGE	13.3x6.5
IF Filter	SF1092A	199	0.2	GSM/EDGE	19x6.5
IF Filter	SF1111A	160	1.3	CDMA	24.6x9
IF Filter	SF1115A	199	0.2	GSM/EDGE	9.1x7.1
IF Filter	SF1120B	298.74	2.2	GPS	7.0x5.0
IF Filter	SF1131B	266	2.2	GPS	7.0x5.0
IF Filter	SF1140B	75	4.2	SDARS	7.0x5.0
IF Filter	SF1140B-2	75	4.2	SDARS	7.0 x 5.0
IF Filter	SF1141B	75	12.7	SDARS	7.0x5.0
IF Filter	SF1141B-2	75	12.7	SDARS	7.0 x 5.0
IF Filter	SF1141B-4	75	12.7	SDARS	7.0 x 5.0
IF Filter	SF1142B	315	4.2	SDARS	7.0x5.0
IF Filter	SF1143B	315	12.7	SDARS	7.0x5.0
IF Filter	SF1143B-1	315	12.7	SDARS	7.0 x 5.0
IF Filter	SF1143B-2	315	12.7	SDARS	7.0 x 5.0
IF Filter	SF1143B-4	315	12.7	SDARS	7.0 x 5.0
IF Filter	SF1145B	427.25	0.03	Cable	7.0x5.0
IF Filter	SF1146B	499.25	0.4	Cable	7.0x5.0
IF Filter	SF1174B	374	17	WLAN	5.0x5.0
IF Filter	SF1174D	374	17	WLAN	3.8x3.8
IF Filter	SF1177A	57.6	21.2	WCDMA/TD-SCDMA	13.3x6.5
IF Filter	SF1179B	184.14	11	IF Filter	7.0x5.0
RF Filter	SF1182B	836.5	25	Cellular	3.0x3.0
RF Filter	SF1183G	881.5	25	Cellular	2.5x2.0
RF Filter	SF1184B-1	947.5	25	GSM	3.0x3.0
RF Filter	SF1186B-2	1575.42	2	GPS	3.0x3.0
RF Filter	SF1186G	1575.42	2	GPS	2.5x2.0
RF Filter	SF1186H	1575.42	2	GPS	2.0x1.6
RF Filter	SF1186H-1	1575.42	2	GPS	2.0x1.6
RF Filter	SF1186H-2	1575.42	2	GPS	2.0x1.6
RF Filter	SF1186K	1575.42	2	GPS	1.4x1.1
RF Filter	SF1188C	465	4	Wireless Access	5.0x5.0
IF Filter	SF1189B-1	280	17.97	Wireless Access	5.0x5.0
RF Filter	SF1192B	1842.5	75	DCS	3.0x3.0
IF Filter	SF1197B	248.6	5	IF Filter	7.0 x 5.0
IF Filter	SF1200B	96	20	TD-SCDMA	7.0x5.0
Duplexer	SF1207C	836.5/881.5	25	CDMA	5.0x5.0
Duplexer	SF1207D	836.5/881.5	25	CDMA	3.8x3.8
RF Filter	SF1208H	2017.5	15	TD-SCDMA	2.0x1.6
RF Filter	SF1218D	453.5	7	CDMA450	3.8x3.8

SAW RF / IF Filters

RF Filter	SF1219K	2338	12.5	SDARS	1.4x1.1
RF Filter	SF1220K	2326	14	SDARS	1.4x1.1
RF Filter	SF2001E	1960	60	PCS	3.0x3.0
RF Filter	SF2002B-2	942.5	35	EGSM	3.0x3.0
RF Filter	SF2002E	942.5	35	EGSM	3.0x3.0
IF Filter	SF2006C	190	4.8	WCDMA	5.0x5.0
RF Filter	SF2008D	930.5	4	Wireless Access	3.8x3.8
IF Filter	SF2017D	1220	8	Cable/DOCSIS	3.8x3.8
IF Filter	SF2024B	467.751	12.688	SDARS	7.0x5.0
IF Filter	SF2024D	467.751	12.5	SDARS	3.8x3.8x1.2
IF Filter	SF2024D-1	467.751	12.5	SDARS	3.8x3.8x1.0
IF Filter	SF2024E-1	467.751	12.5	SDARS	3.0x3.0x0.9
IF Filter	SF2024E-2	467.751	12.5	SDARS	3.0x3.0x0.9
IF Filter	SF2025B	259.861	12.708	SDARS	7.0x5.0
IF Filter	SF2026B	114.815	6.3	SDARS	7.0x5.0
IF Filter	SF2027B	199	0.2	GSM/EDGE	13.3x6.5
IF Filter	SF2030A	243.95	0.3	PHS	11.5x4.0
IF Filter	SF2032E	1220	28	Cable/DOCSIS	3.0x3.0
IF Filter	SF2033A	350	2.4	IF Filter	13.3x6.5
RF Filter	SF2036E	1880	60	DCS	3.0x3.0
IF Filter	SF2037B	76.5	3.8	SDARS	7.0x5.0
IF Filter	SF2037B-2	76.5	3.8	SDARS	7.0x5.0
IF Filter	SF2037B-3	76.5	3.8	SDARS	7.0x5.0
IF Filter	SF2038B	76.5	12.5	SDARS	7.0x5.0
IF Filter	SF2038B-2	76.5	12.5	SDARS	7.0x5.0
IF Filter	SF2038B-3	76.5	12.5	SDARS	7.0 x 5.0
IF Filter	SF2039B	72.54	3.7	SDARS	7.0x5.0
IF Filter	SF2039B-2	72.54	3.7	SDARS	7.0x5.0
IF Filter	SF2039B-3	72.54	3.7	SDARS	7.0 x 5.0
IF Filter	SF2040B	80.46	3.7	SDARS	7.0x5.0
IF Filter	SF2040B-2	80.46	3.7	SDARS	7.0x5.0
IF Filter	SF2040B-3	80.46	3.7	SDARS	7.0x5.0
IF Filter	SF2042B	456	15	Wimax	5.0x7.0
IF Filter	SF2042C	456	15	Wimax	5.0x5.0
IF Filter	SF2045A	140	10	IF Filter	13.3x6.5
IF Filter	SF2046B	456.44	5.22	Wimax	7.0x5.0
RF Filter	SF2049E	915	26	ISM Band	3.0x3.0
RF Filter	SF2053E	915	12.5	ISM Band	3.0x3.0
IF Filter	SF2055A	240.05	0.3	PHS	11.5x4.0
RF Filter	SF2059B-1	137.5	1	Orbcomm	5.0x7.0
IF Filter	SF2060B	115	12.5	SDARS	5.0x7.0
IF Filter	SF2060B-1	115	12.5	SDARS	5.0x7.0
IF Filter	SF2062A	229.25	0.3	PHS	11.0x4.0
IF Filter	SF2063A	156	9	Wibro	13.3x6.5
IF Filter	SF2064A	156	10	Wimax	13.3x6.5
RF Filter	SF2065C	743	6	Wimax	5.0x5.0
IF Filter	SF2067B	172.8	8.84	WCDMA	7.0x5.0
IF Filter	SF2069A	96	4.8	TD-SCDMA	13.3x6.5
IF Filter	SF2069A-1	96	4.8	TD-SCDMA	19.0x6.5
IF Filter	SF2069A-2	96	5	TD-SCDMA	13.3x6.5
IF Filter	SF2072C	360	30	Wimax	5.0x5.0

IF Filter	SF2073B	456	10	Wimax	7.0x5.0
IF Filter	SF2076B	464	3.7	Wimax	7.0x5.0
IF Filter	SF2079D	251	12.5	SDARS	3.8x3.8
IF Filter	SF2081D	1220	50	Cable/DOCSIS	3.8x3.8
IF Filter	SF2081E	1220	50	Cable/DOCSIS	3.0x3.0
IF Filter	SF2085A	96	30	IF Filter	13.3x6.5
IF Filter	SF2086C	235	30	IF Filter	5.0x5.0
IF Filter	SF2087C	265	30	IF Filter	5.0x5.0
IF Filter	SF2088C	295	30	IF Filter	5.0x5.0
IF Filter	SF2089C	325	30	IF Filter	5.0x5.0
IF Filter	SF2090C	355	30	IF Filter	5.0x5.0
IF Filter	SF2091C	385	30	IF Filter	5.0x5.0
RF Filter	SF2092E	810	17	RF Filter	3.0x3.0
RF Filter	SF2093E	915	26	ISM band RF Filter	3.0x3.0
IF Filter	SF2094B	380	4	Wimax	7.0x5.0
RF Filter	SF2098G	915	26	ISM band RF Filter	2.5x2.0
RF Filter	SF2101D	455	5	CDMA450	3.8x3.8
RF Filter	SF2102D	465	5	CDMA450	3.8x3.8
IF Filter	SF2109D	305	8.4	Wibro	3.8x3.8
IF Filter	SF2110D	305	10	Wimax	3.8x3.8
IF Filter	SF2111A	140	15	TD-SCDMA	13.3x6.5
RF Filter	SF2112D	452.5	5	CDMA450	3.8x3.8
RF Filter	SF2113D	462.5	5	CDMA450	3.8x3.8
RF Filter	SF2114D	413.76	5	CDMA450	3.8x3.8
RF Filter	SF2115D	423.76	5	CDMA450	3.8x3.8
RF Filter	SF2116D	481.25	5	CDMA450	3.8x3.8
RF Filter	SF2117D	491.25	5	CDMA450	3.8x3.8
RF Filter	SF2120C	149	2	Orbcomm	5.0x5.0
RF Filter	SF2124E	2441.8	83.5	ISM Band	3.0x3.0
IF Filter	SF2125D	305	5	Wimax	3.8x3.8
RF Filter	SF2126E	725	50	WIMAX	3.0x3.0
IF Filter	SF2131B	92.16	20	TD-SCDMA	7.0x5.0
RF Filter	SF2133E	1745.5	75	RF Filter	3.0x3.0
RF Filter	SF2134E	897.5	35	RF Filter	3.0x3.0
IF Filter	SF2135A	96	1.8	IF Filter	13.3x6.5
RF Filter	SF2136E	433.92	7	ISM band RF Filter	3.0x3.0
RF Filter	SF2137D	869	2	ISM band RF Filter	3.8x3.8
RF Filter	SF2137E	869	2	ISM band RF Filter	3.0x3.0
IF Filter	SF2138B	144	12.5	SDARS	7.0x5.0
IF Filter	SF2139D	177	20	CDMA2000	3.8x3.8
IF Filter	SF2140A	140	20	WCDMA/TD-SCDMA	13.3x6.5
RF Filter	SF2141B	210.38	1.2	CDMA	7.0x5.0
RF Filter	SF2142G	867.5	25	RF Filter	2.5x2.0
Diplexer	SF2143A	72.54/80.46	4	SDARS	11.4x5.3
Diplexer	SF2143B	72.54/80.46	4	SDARS	7.0x5.0
RF Filter	SF2146D	415	30	RF Filter	3.8x3.8
IF Filter	SF2147D	157	20	CDMA2000	3.8x3.8
IF Filter	SF2148B	138.24	20	LTE/TD-SCDMA	5.0x5.0
IF Filter	SF2149A	46.08	5	TD-SCDMA	13.3x6.5
RF Filter	SF2150E	915	10	ISM band RF Filter	3.0x3.0
IF Filter	SF2151B	211.2	20	LTE/WCDMA	5.0x7.0

SAW RF / IF Filters

SAW RF / IF Filter				Select by Frequency	
Type	Product No.	Freq. (MHz)	BW (MHz)	Application	Case (mm)
IF Filter	SF2149A	46.08	5	TD-SCDMA	13.3x6.5
IF Filter	SF1177A	57.6	21.2	WCDMA/TD-SCDMA	13.3x6.5
IF Filter	SF1081A	71	0.2	GSM/EDGE	22.1x8.0
IF Filter	SF1081A-1	71	0.2	GSM/EDGE	22.1x8.0
IF Filter	SF2039B	72.54	3.7	SDARS	7.0x5.0
IF Filter	SF2039B-2	72.54	3.7	SDARS	7.0x5.0
IF Filter	SF2039B-3	72.54	3.7	SDARS	7.0 x 5.0
Diplexer	SF2143A	72.54/80.46	4	SDARS	11.4x5.3
Diplexer	SF2143B	72.54/80.46	4	SDARS	7.0x5.0
Duplexer	SF1207C	836.5/881.5	25	CDMA	5.0x5.0
Duplexer	SF1207D	836.5/881.5	25	CDMA	3.8x3.8
IF Filter	SF1140B	75	4.2	SDARS	7.0x5.0
IF Filter	SF1140B-2	75	4.2	SDARS	7.0 x 5.0
IF Filter	SF1141B	75	12.7	SDARS	7.0x5.0
IF Filter	SF1141B-2	75	12.7	SDARS	7.0 x 5.0
IF Filter	SF1141B-4	75	12.7	SDARS	7.0 x 5.0
IF Filter	SF2037B	76.5	3.8	SDARS	7.0x5.0
IF Filter	SF2037B-2	76.5	3.8	SDARS	7.0x5.0
IF Filter	SF2037B-3	76.5	3.8	SDARS	7.0x5.0
IF Filter	SF2038B	76.5	12.5	SDARS	7.0x5.0
IF Filter	SF2038B-2	76.5	12.5	SDARS	7.0x5.0
IF Filter	SF2038B-3	76.5	12.5	SDARS	7.0 x 5.0
IF Filter	SF2040B	80.46	3.7	SDARS	7.0x5.0
IF Filter	SF2040B-2	80.46	3.7	SDARS	7.0x5.0
IF Filter	SF2040B-3	80.46	3.7	SDARS	7.0x5.0
IF Filter	PX1004	82.2	0.03	IS-54 TDMA	13.3x6.5
IF Filter	PX1002	86.85	0.024	IS-54 TDMA	13.3x6.5
IF Filter	SF2131B	92.16	20	TD-SCDMA	7.0x5.0
IF Filter	SF1200B	96	20	TD-SCDMA	7.0x5.0
IF Filter	SF2069A	96	4.8	TD-SCDMA	13.3x6.5
IF Filter	SF2069A-1	96	4.8	TD-SCDMA	19.0x6.5
IF Filter	SF2069A-2	96	5	TD-SCDMA	13.3x6.5
IF Filter	SF2085A	96	30	IF Filter	13.3x6.5
IF Filter	SF2135A	96	1.8	IF Filter	13.3x6.5
IF Filter	SF1056A	110.592	1.152	DECT	13.3x6.5
IF Filter	SF2026B	114.815	6.3	SDARS	7.0x5.0
IF Filter	SF2060B	115	12.5	SDARS	5.0x7.0
IF Filter	SF2060B-1	115	12.5	SDARS	5.0x7.0
RF Filter	SF2059B-1	137.5	1	Orbcomm	5.0x7.0
IF Filter	SF2148B	138.24	20	LTE/TD-SCDMA	5.0x5.0
IF Filter	SF2045A	140	10	IF Filter	13.3x6.5
IF Filter	SF2111A	140	15	TD-SCDMA	13.3x6.5
IF Filter	SF2140A	140	20	WCDMA/TD-SCDMA	13.3x6.5
IF Filter	SF2138B	144	12.5	SDARS	7.0x5.0
RF Filter	SF2120C	149	2	Orbcomm	5.0x5.0
IF Filter	SF2063A	156	9	Wibro	13.3x6.5
IF Filter	SF2064A	156	10	Wimax	13.3x6.5
IF Filter	SF2147D	157	20	CDMA2000	3.8x3.8
IF Filter	SF1111A	160	1.3	CDMA	24.6x9
IF Filter	SF1088A	170.6	0.18	GSM/EDGE	19x6.5

IF Filter	SF2067B	172.8	8.84	WCDMA	7.0x5.0
IF Filter	SF2139D	177	20	CDMA2000	3.8x3.8
IF Filter	SF1179B	184.14	11	IF Filter	7.0x5.0
IF Filter	SF2006C	190	4.8	WCDMA	5.0x5.0
IF Filter	SF1092A	199	0.2	GSM/EDGE	19x6.5
IF Filter	SF1115A	199	0.2	GSM/EDGE	9.1x7.1
IF Filter	SF2027B	199	0.2	GSM/EDGE	13.3x6.5
RF Filter	SF2141B	210.38	1.2	CDMA	7.0x5.0
IF Filter	SF1091A	211	0.9	GSM/EDGE	13.3x6.5
IF Filter	SF2151B	211.2	20	LTE/WCDMA	5.0x7.0
IF Filter	SF2062A	229.25	0.3	PHS	11.0x4.0
IF Filter	SF2086C	235	30	IF Filter	5.0x5.0
IF Filter	SF2055A	240.05	0.3	PHS	11.5x4.0
IF Filter	SF2030A	243.95	0.3	PHS	11.5x4.0
IF Filter	SF1197B	248.6	5	IF Filter	7.0 x 5.0
IF Filter	SF2079D	251	12.5	SDARS	3.8x3.8
IF Filter	SF2025B	259.861	12.708	SDARS	7.0x5.0
IF Filter	SF2087C	265	30	IF Filter	5.0x5.0
IF Filter	SF1131B	266	2.2	GPS	7.0x5.0
IF Filter	SF1189B-1	280	17.97	Wireless Access	5.0x5.0
IF Filter	SF2088C	295	30	IF Filter	5.0x5.0
RF Filter	RF1199	297.4	0.6	Filter	TO39-3
IF Filter	SF1120B	298.74	2.2	GPS	7.0x5.0
IF Filter	SF2109D	305	8.4	Wibro	3.8x3.8
IF Filter	SF2110D	305	10	Wimax	3.8x3.8
IF Filter	SF2125D	305	5	Wimax	3.8x3.8
IF Filter	SF1142B	315	4.2	SDARS	7.0x5.0
IF Filter	SF1143B	315	12.7	SDARS	7.0x5.0
IF Filter	SF1143B-1	315	12.7	SDARS	7.0 x 5.0
IF Filter	SF1143B-2	315	12.7	SDARS	7.0 x 5.0
IF Filter	SF1143B-4	315	12.7	SDARS	7.0 x 5.0
IF Filter	SF2089C	325	30	IF Filter	5.0x5.0
IF Filter	SF1059A	350	0.8	IF Filter	9.1x7.1
IF Filter	SF2033A	350	2.4	IF Filter	13.3x6.5
IF Filter	SF2090C	355	30	IF Filter	5.0x5.0
IF Filter	SF2072C	360	30	Wimax	5.0x5.0
IF Filter	SF1174B	374	17	WLAN	5.0x5.0
IF Filter	SF1174D	374	17	WLAN	3.8x3.8
IF Filter	SF2094B	380	4	Wimax	7.0x5.0
IF Filter	SF2091C	385	30	IF Filter	5.0x5.0
RF Filter	SF2114D	413.76	5	CDMA450	3.8x3.8
RF Filter	SF2146D	415	30	RF Filter	3.8x3.8
RF Filter	SF2115D	423.76	5	CDMA450	3.8x3.8
IF Filter	SF1145B	427.25	0.03	Cable	7.0x5.0
RF Filter	SF2136E	433.92	7	ISM band RF Filter	3.0x3.0
RF Filter	RF1302	439.25	0.06	Narrowband RF Filter	TO39-3
RF Filter	SF2112D	452.5	5	CDMA450	3.8x3.8
RF Filter	SF1218D	453.5	7	CDMA450	3.8x3.8
RF Filter	SF2101D	455	5	CDMA450	3.8x3.8
IF Filter	SF2042B	456	15	Wimax	5.0x7.0
IF Filter	SF2042C	456	15	Wimax	5.0x5.0
IF Filter	SF2073B	456	10	Wimax	7.0x5.0
IF Filter	SF2046B	456.44	5.22	Wimax	7.0x5.0

SAW RF / IF Filters

RF Filter	SF2113D	462.5	5	CDMA450	3.8x3.8
IF Filter	SF2076B	464	3.7	Wimax	7.0x5.0
RF Filter	SF1188C	465	4	Wireless Access	5.0x5.0
RF Filter	SF2102D	465	5	CDMA450	3.8x3.8
IF Filter	SF2024B	467.751	12.688	SDARS	7.0x5.0
IF Filter	SF2024D	467.751	12.5	SDARS	3.8x3.8x1.2
IF Filter	SF2024D-1	467.751	12.5	SDARS	3.8x3.8x1.0
IF Filter	SF2024E-1	467.751	12.5	SDARS	3.0x3.0x0.9
IF Filter	SF2024E-2	467.751	12.5	SDARS	3.0x3.0x0.9
RF Filter	SF2116D	481.25	5	CDMA450	3.8x3.8
RF Filter	SF2117D	491.25	5	CDMA450	3.8x3.8
RF Filter	RF1301	499.25	0.06	Narrowband RF Filter	TO39-3
IF Filter	SF1146B	499.25	0.4	Cable	7.0x5.0
RF Filter	SF2126E	725	50	WIMAX	3.0x3.0
RF Filter	SF2065C	743	6	Wimax	5.0x5.0
RF Filter	SF2092E	810	17	RF Filter	3.0x3.0
RF Filter	SF1182B	836.5	25	Cellular	3.0x3.0
RF Filter	SF2142G	867.5	25	RF Filter	2.5x2.0
RF Filter	SF2137D	869	2	ISM band RF Filter	3.8x3.8
RF Filter	SF2137E	869	2	ISM band RF Filter	3.0x3.0
RF Filter	SF1183G	881.5	25	Cellular	2.5x2.0
RF Filter	SF2134E	897.5	35	RF Filter	3.0x3.0
RF Filter	SF2049E	915	26	ISM Band	3.0x3.0
RF Filter	SF2053E	915	12.5	ISM Band	3.0x3.0
RF Filter	SF2093E	915	26	ISM band RF Filter	3.0x3.0
RF Filter	SF2098G	915	26	ISM band RF Filter	2.5x2.0
RF Filter	SF2150E	915	10	ISM band RF Filter	3.0x3.0
RF Filter	SF2008D	930.5	4	Wireless Access	3.8x3.8
RF Filter	SF2002B-2	942.5	35	EGSM	3.0x3.0
RF Filter	SF2002E	942.5	35	EGSM	3.0x3.0
RF Filter	SF1184B-1	947.5	25	GSM	3.0x3.0
IF Filter	SF2017D	1220	8	Cable/DOCSIS	3.8x3.8
IF Filter	SF2032E	1220	28	Cable/DOCSIS	3.0x3.0
IF Filter	SF2081D	1220	50	Cable/DOCSIS	3.8x3.8
IF Filter	SF2081E	1220	50	Cable/DOCSIS	3.0x3.0
RF Filter	SF1186B-2	1575.42	2	GPS	3.0x3.0
RF Filter	SF1186G	1575.42	2	GPS	2.5x2.0
RF Filter	SF1186H	1575.42	2	GPS	2.0x1.6
RF Filter	SF1186H-1	1575.42	2	GPS	2.0x1.6
RF Filter	SF1186H-2	1575.42	2	GPS	2.0x1.6
RF Filter	SF1186K	1575.42	2	GPS	1.4x11
RF Filter	SF2133E	1745.5	75	RF Filter	3.0x3.0
RF Filter	SF1192B	1842.5	75	DCS	3.0x3.0
RF Filter	SF2036E	1880	60	DCS	3.0x3.0
RF Filter	SF2001E	1960	60	PCS	3.0x3.0
RF Filter	SF1208H	2017.5	15	TD-SCDMA	2.0x1.6
RF Filter	SF1220K	2326	14	SDARS	1.4x1.1
RF Filter	SF1219K	2338	12.5	SDARS	1.4x1.1
RF Filter	SF2124E	2441.8	83.5	ISM Band	3.0x3.0

SAW RF / IF Filter				Select by Bandwidth	
Type	Product No.	Freq. (MHz)	BW (MHz)	Application	Case (mm)
IF Filter	PX1002	86.85	0.024	IS-54 TDMA	13.3x6.5
IF Filter	PX1004	82.2	0.03	IS-54 TDMA	13.3x6.5
IF Filter	SF1145B	427.25	0.03	Cable	7.0x5.0
RF Filter	RF1302	439.25	0.06	Narrowband RF Filter	TO39-3
RF Filter	RF1301	499.25	0.06	Narrowband RF Filter	TO39-3
IF Filter	SF1088A	170.6	0.18	GSM/EDGE	19x6.5
IF Filter	SF1081A	71	0.2	GSM/EDGE	22.1x8.0
IF Filter	SF1081A-1	71	0.2	GSM/EDGE	22.1x8.0
IF Filter	SF1092A	199	0.2	GSM/EDGE	19x6.5
IF Filter	SF1115A	199	0.2	GSM/EDGE	9.1x7.1
IF Filter	SF2027B	199	0.2	GSM/EDGE	13.3x6.5
IF Filter	SF2062A	229.25	0.3	PHS	11.0x4.0
IF Filter	SF2055A	240.05	0.3	PHS	11.5x4.0
IF Filter	SF2030A	243.95	0.3	PHS	11.5x4.0
IF Filter	SF1146B	499.25	0.4	Cable	7.0x5.0
RF Filter	RF1199	297.4	0.6	Filter	TO39-3
IF Filter	SF1059A	350	0.8	IF Filter	9.1x7.1
IF Filter	SF1091A	211	0.9	GSM/EDGE	13.3x6.5
RF Filter	SF2059B-1	137.5	1	Orbcomm	5.0x7.0
IF Filter	SF1056A	110.592	1.152	DECT	13.3x6.5
RF Filter	SF2141B	210.38	1.2	CDMA	7.0x5.0
IF Filter	SF1111A	160	1.3	CDMA	24.6x9
IF Filter	SF2135A	96	1.8	IF Filter	13.3x6.5
RF Filter	SF2120C	149	2	Orbcomm	5.0x5.0
RF Filter	SF2137D	869	2	ISM band RF Filter	3.8x3.8
RF Filter	SF2137E	869	2	ISM band RF Filter	3.0x3.0
RF Filter	SF1186B-2	1575.42	2	GPS	3.0x3.0
RF Filter	SF1186G	1575.42	2	GPS	2.5x2.0
RF Filter	SF1186H	1575.42	2	GPS	2.0x1.6
RF Filter	SF1186H-1	1575.42	2	GPS	2.0x1.6
RF Filter	SF1186H-2	1575.42	2	GPS	2.0x1.6
RF Filter	SF1186K	1575.42	2	GPS	1.4x11
IF Filter	SF1131B	266	2.2	GPS	7.0x5.0
IF Filter	SF1120B	298.74	2.2	GPS	7.0x5.0
IF Filter	SF2033A	350	2.4	IF Filter	13.3x6.5
IF Filter	SF2039B	72.54	3.7	SDARS	7.0x5.0
IF Filter	SF2039B-2	72.54	3.7	SDARS	7.0x5.0
IF Filter	SF2039B-3	72.54	3.7	SDARS	7.0 x 5.0
IF Filter	SF2040B	80.46	3.7	SDARS	7.0x5.0
IF Filter	SF2040B-2	80.46	3.7	SDARS	7.0x5.0
IF Filter	SF2040B-3	80.46	3.7	SDARS	7.0x5.0
IF Filter	SF2076B	464	3.7	Wimax	7.0x5.0
IF Filter	SF2037B	76.5	3.8	SDARS	7.0x5.0
IF Filter	SF2037B-2	76.5	3.8	SDARS	7.0x5.0
IF Filter	SF2037B-3	76.5	3.8	SDARS	7.0x5.0
IF Filter	SF2094B	380	4	Wimax	7.0x5.0
RF Filter	SF1188C	465	4	Wireless Access	5.0x5.0
RF Filter	SF2008D	930.5	4	Wireless Access	3.8x3.8

SAW RF / IF Filters

Diplexer	SF2143A	72.54/80.46	4	SDARS	11.4x5.3
Diplexer	SF2143B	72.54/80.46	4	SDARS	7.0x5.0
IF Filter	SF1140B	75	4.2	SDARS	7.0x5.0
IF Filter	SF1140B-2	75	4.2	SDARS	7.0 x 5.0
IF Filter	SF1142B	315	4.2	SDARS	7.0x5.0
IF Filter	SF2069A	96	4.8	TD-SCDMA	13.3x6.5
IF Filter	SF2069A-1	96	4.8	TD-SCDMA	19.0x6.5
IF Filter	SF2006C	190	4.8	WCDMA	5.0x5.0
IF Filter	SF2149A	46.08	5	TD-SCDMA	13.3x6.5
IF Filter	SF2069A-2	96	5	TD-SCDMA	13.3x6.5
IF Filter	SF1197B	248.6	5	IF Filter	7.0 x 5.0
IF Filter	SF2125D	305	5	Wimax	3.8x3.8
RF Filter	SF2114D	413.76	5	CDMA450	3.8x3.8
RF Filter	SF2115D	423.76	5	CDMA450	3.8x3.8
RF Filter	SF2112D	452.5	5	CDMA450	3.8x3.8
RF Filter	SF2101D	455	5	CDMA450	3.8x3.8
RF Filter	SF2113D	462.5	5	CDMA450	3.8x3.8
RF Filter	SF2102D	465	5	CDMA450	3.8x3.8
RF Filter	SF2116D	481.25	5	CDMA450	3.8x3.8
RF Filter	SF2117D	491.25	5	CDMA450	3.8x3.8
IF Filter	SF2046B	456.44	5.22	Wimax	7.0x5.0
RF Filter	SF2065C	743	6	Wimax	5.0x5.0
IF Filter	SF2026B	114.815	6.3	SDARS	7.0x5.0
RF Filter	SF2136E	433.92	7	ISM band RF Filter	3.0x3.0
RF Filter	SF1218D	453.5	7	CDMA450	3.8x3.8
IF Filter	SF2017D	1220	8	Cable/DOCSIS	3.8x3.8
IF Filter	SF2109D	305	8.4	Wibro	3.8x3.8
IF Filter	SF2067B	172.8	8.84	WCDMA	7.0x5.0
IF Filter	SF2063A	156	9	Wibro	13.3x6.5
IF Filter	SF2045A	140	10	IF Filter	13.3x6.5
IF Filter	SF2064A	156	10	Wimax	13.3x6.5
IF Filter	SF2110D	305	10	Wimax	3.8x3.8
IF Filter	SF2073B	456	10	Wimax	7.0x5.0
RF Filter	SF2150E	915	10	ISM band RF Filter	3.0x3.0
IF Filter	SF1179B	184.14	11	IF Filter	7.0x5.0
IF Filter	SF2038B	76.5	12.5	SDARS	7.0x5.0
IF Filter	SF2038B-2	76.5	12.5	SDARS	7.0x5.0
IF Filter	SF2038B-3	76.5	12.5	SDARS	7.0 x 5.0
IF Filter	SF2060B	115	12.5	SDARS	5.0x7.0
IF Filter	SF2060B-1	115	12.5	SDARS	5.0x7.0
IF Filter	SF2138B	144	12.5	SDARS	7.0x5.0
IF Filter	SF2079D	251	12.5	SDARS	3.8x3.8
IF Filter	SF2024D	467.751	12.5	SDARS	3.8x3.8x1.2
IF Filter	SF2024D-1	467.751	12.5	SDARS	3.8x3.8x1.0
IF Filter	SF2024E-1	467.751	12.5	SDARS	3.0x3.0x0.9
IF Filter	SF2024E-2	467.751	12.5	SDARS	3.0x3.0x0.9
RF Filter	SF2053E	915	12.5	ISM Band	3.0x3.0
RF Filter	SF1219K	2338	12.5	SDARS	1.4x1.1
IF Filter	SF2024B	467.751	12.688	SDARS	7.0x5.0
IF Filter	SF1141B	75	12.7	SDARS	7.0x5.0
IF Filter	SF1141B-2	75	12.7	SDARS	7.0 x 5.0
IF Filter	SF1141B-4	75	12.7	SDARS	7.0 x 5.0
IF Filter	SF1143B	315	12.7	SDARS	7.0x5.0

IF Filter	SF1143B-1	315	12.7	SDARS	7.0 x 5.0
IF Filter	SF1143B-2	315	12.7	SDARS	7.0 x 5.0
IF Filter	SF1143B-4	315	12.7	SDARS	7.0 x 5.0
IF Filter	SF2025B	259.861	12.708	SDARS	7.0x5.0
RF Filter	SF1220K	2326	14	SDARS	1.4x1.1
IF Filter	SF2111A	140	15	TD-SCDMA	13.3x6.5
IF Filter	SF2042B	456	15	Wimax	5.0x7.0
IF Filter	SF2042C	456	15	Wimax	5.0x5.0
RF Filter	SF1208H	2017.5	15	TD-SCDMA	2.0x1.6
IF Filter	SF1174B	374	17	WLAN	5.0x5.0
IF Filter	SF1174D	374	17	WLAN	3.8x3.8
RF Filter	SF2092E	810	17	RF Filter	3.0x3.0
IF Filter	SF1189B-1	280	17.97	Wireless Access	5.0x5.0
IF Filter	SF2131B	92.16	20	TD-SCDMA	7.0x5.0
IF Filter	SF1200B	96	20	TD-SCDMA	7.0x5.0
IF Filter	SF2148B	138.24	20	LTE/TD-SCDMA	5.0x5.0
IF Filter	SF2140A	140	20	WCDMA/TD-SCDMA	13.3x6.5
IF Filter	SF2147D	157	20	CDMA2000	3.8x3.8
IF Filter	SF2139D	177	20	CDMA2000	3.8x3.8
IF Filter	SF2151B	211.2	20	LTE/WCDMA	5.0x7.0
IF Filter	SF1177A	57.6	21.2	WCDMA/TD-SCDMA	13.3x6.5
RF Filter	SF1182B	836.5	25	Cellular	3.0x3.0
RF Filter	SF2142G	867.5	25	RF Filter	2.5x2.0
RF Filter	SF1183G	881.5	25	Cellular	2.5x2.0
RF Filter	SF1184B-1	947.5	25	GSM	3.0x3.0
Duplexer	SF1207C	836.5/881.5	25	CDMA	5.0x5.0
Duplexer	SF1207D	836.5/881.5	25	CDMA	3.8x3.8
RF Filter	SF2049E	915	26	ISM Band	3.0x3.0
RF Filter	SF2093E	915	26	ISM band RF Filter	3.0x3.0
RF Filter	SF2098G	915	26	ISM band RF Filter	2.5x2.0
IF Filter	SF2032E	1220	28	Cable/DOCSIS	3.0x3.0
IF Filter	SF2085A	96	30	IF Filter	13.3x6.5
IF Filter	SF2086C	235	30	IF Filter	5.0x5.0
IF Filter	SF2087C	265	30	IF Filter	5.0x5.0
IF Filter	SF2088C	295	30	IF Filter	5.0x5.0
IF Filter	SF2089C	325	30	IF Filter	5.0x5.0
IF Filter	SF2090C	355	30	IF Filter	5.0x5.0
IF Filter	SF2072C	360	30	Wimax	5.0x5.0
IF Filter	SF2091C	385	30	IF Filter	5.0x5.0
RF Filter	SF2146D	415	30	RF Filter	3.8x3.8
RF Filter	SF2134E	897.5	35	RF Filter	3.0x3.0
RF Filter	SF2002B-2	942.5	35	EGSM	3.0x3.0
RF Filter	SF2002E	942.5	35	EGSM	3.0x3.0
RF Filter	SF2126E	725	50	WIMAX	3.0x3.0
IF Filter	SF2081D	1220	50	Cable/DOCSIS	3.8x3.8
IF Filter	SF2081E	1220	50	Cable/DOCSIS	3.0x3.0
RF Filter	SF2036E	1880	60	DCS	3.0x3.0
RF Filter	SF2001E	1960	60	PCS	3.0x3.0
RF Filter	SF2133E	1745.5	75	RF Filter	3.0x3.0
RF Filter	SF1192B	1842.5	75	DCS	3.0x3.0
RF Filter	SF2124E	2441.8	83.5	ISM Band	3.0x3.0

SAW RF / IF Filters

SAW RF / IF Filter				Select by Typical Application	
Type	Product No.	Freq. (MHz)	BW (MHz)	Application	Case (mm)
IF Filter	SF1145B	427.25	0.03	Cable	7.0x5.0
IF Filter	SF1146B	499.25	0.4	Cable	7.0x5.0
IF Filter	SF2017D	1220	8	Cable/DOCSIS	3.8x3.8
IF Filter	SF2032E	1220	28	Cable/DOCSIS	3.0x3.0
IF Filter	SF2081D	1220	50	Cable/DOCSIS	3.8x3.8
IF Filter	SF2081E	1220	50	Cable/DOCSIS	3.0x3.0
RF Filter	SF2141B	210.38	1.2	CDMA	7.0x5.0
IF Filter	SF1111A	160	1.3	CDMA	24.6x9
Duplexer	SF1207C	836.5/881.5	25	CDMA	5.0x5.0
Duplexer	SF1207D	836.5/881.5	25	CDMA	3.8x3.8
IF Filter	SF2147D	157	20	CDMA2000	3.8x3.8
IF Filter	SF2139D	177	20	CDMA2000	3.8x3.8
RF Filter	SF2114D	413.76	5	CDMA450	3.8x3.8
RF Filter	SF2115D	423.76	5	CDMA450	3.8x3.8
RF Filter	SF2112D	452.5	5	CDMA450	3.8x3.8
RF Filter	SF2101D	455	5	CDMA450	3.8x3.8
RF Filter	SF2113D	462.5	5	CDMA450	3.8x3.8
RF Filter	SF2102D	465	5	CDMA450	3.8x3.8
RF Filter	SF2116D	481.25	5	CDMA450	3.8x3.8
RF Filter	SF2117D	491.25	5	CDMA450	3.8x3.8
RF Filter	SF1218D	453.5	7	CDMA450	3.8x3.8
RF Filter	SF1182B	836.5	25	Cellular	3.0x3.0
RF Filter	SF1183G	881.5	25	Cellular	2.5x2.0
RF Filter	SF2036E	1880	60	DCS	3.0x3.0
RF Filter	SF1192B	1842.5	75	DCS	3.0x3.0
IF Filter	SF1056A	110.592	1.152	DECT	13.3x6.5
RF Filter	SF2002B-2	942.5	35	EGSM	3.0x3.0
RF Filter	SF2002E	942.5	35	EGSM	3.0x3.0
RF Filter	RF1199	297.4	0.6	Filter	TO39-3
RF Filter	SF1186B-2	1575.42	2	GPS	3.0x3.0
RF Filter	SF1186G	1575.42	2	GPS	2.5x2.0
RF Filter	SF1186H	1575.42	2	GPS	2.0x1.6
RF Filter	SF1186H-1	1575.42	2	GPS	2.0x1.6
RF Filter	SF1186H-2	1575.42	2	GPS	2.0x1.6
RF Filter	SF1186K	1575.42	2	GPS	1.4x11
IF Filter	SF1131B	266	2.2	GPS	7.0x5.0
IF Filter	SF1120B	298.74	2.2	GPS	7.0x5.0
RF Filter	SF1184B-1	947.5	25	GSM	3.0x3.0
IF Filter	SF1088A	170.6	0.18	GSM/EDGE	19x6.5
IF Filter	SF1081A	71	0.2	GSM/EDGE	22.1x8.0
IF Filter	SF1081A-1	71	0.2	GSM/EDGE	22.1x8.0
IF Filter	SF1092A	199	0.2	GSM/EDGE	19x6.5
IF Filter	SF1115A	199	0.2	GSM/EDGE	9.1x7.1
IF Filter	SF2027B	199	0.2	GSM/EDGE	13.3x6.5
IF Filter	SF1091A	211	0.9	GSM/EDGE	13.3x6.5
IF Filter	SF1059A	350	0.8	IF Filter	9.1x7.1
IF Filter	SF2135A	96	1.8	IF Filter	13.3x6.5
IF Filter	SF2033A	350	2.4	IF Filter	13.3x6.5
IF Filter	SF1197B	248.6	5	IF Filter	7.0 x 5.0
IF Filter	SF2045A	140	10	IF Filter	13.3x6.5
IF Filter	SF1179B	184.14	11	IF Filter	7.0x5.0

IF Filter	SF2085A	96	30	IF Filter	13.3x6.5
IF Filter	SF2086C	235	30	IF Filter	5.0x5.0
IF Filter	SF2087C	265	30	IF Filter	5.0x5.0
IF Filter	SF2088C	295	30	IF Filter	5.0x5.0
IF Filter	SF2089C	325	30	IF Filter	5.0x5.0
IF Filter	SF2090C	355	30	IF Filter	5.0x5.0
IF Filter	SF2091C	385	30	IF Filter	5.0x5.0
IF Filter	PX1002	86.85	0.024	IS-54 TDMA	13.3x6.5
IF Filter	PX1004	82.2	0.03	IS-54 TDMA	13.3x6.5
RF Filter	SF2053E	915	12.5	ISM Band	3.0x3.0
RF Filter	SF2049E	915	26	ISM Band	3.0x3.0
RF Filter	SF2124E	2441.8	83.5	ISM Band	3.0x3.0
RF Filter	SF2137D	869	2	ISM band RF Filter	3.8x3.8
RF Filter	SF2137E	869	2	ISM band RF Filter	3.0x3.0
RF Filter	SF2136E	433.92	7	ISM band RF Filter	3.0x3.0
RF Filter	SF2150E	915	10	ISM band RF Filter	3.0x3.0
RF Filter	SF2093E	915	26	ISM band RF Filter	3.0x3.0
RF Filter	SF2098G	915	26	ISM band RF Filter	2.5x2.0
IF Filter	SF2148B	138.24	20	LTE/TD-SCDMA	5.0x5.0
IF Filter	SF2151B	211.2	20	LTE/WCDMA	5.0x7.0
RF Filter	RF1302	439.25	0.06	Narrowband RF Filter	TO39-3
RF Filter	RF1301	499.25	0.06	Narrowband RF Filter	TO39-3
RF Filter	SF2059B-1	137.5	1	Orbcomm	5.0x7.0
RF Filter	SF2120C	149	2	Orbcomm	5.0x5.0
RF Filter	SF2001E	1960	60	PCS	3.0x3.0
IF Filter	SF2062A	229.25	0.3	PHS	11.0x4.0
IF Filter	SF2055A	240.05	0.3	PHS	11.5x4.0
IF Filter	SF2030A	243.95	0.3	PHS	11.5x4.0
RF Filter	SF2092E	810	17	RF Filter	3.0x3.0
RF Filter	SF2142G	867.5	25	RF Filter	2.5x2.0
RF Filter	SF2146D	415	30	RF Filter	3.8x3.8
RF Filter	SF2134E	897.5	35	RF Filter	3.0x3.0
RF Filter	SF2133E	1745.5	75	RF Filter	3.0x3.0
IF Filter	SF2039B	72.54	3.7	SDARS	7.0x5.0
IF Filter	SF2039B-2	72.54	3.7	SDARS	7.0x5.0
IF Filter	SF2039B-3	72.54	3.7	SDARS	7.0 x 5.0
IF Filter	SF2040B	80.46	3.7	SDARS	7.0x5.0
IF Filter	SF2040B-2	80.46	3.7	SDARS	7.0x5.0
IF Filter	SF2040B-3	80.46	3.7	SDARS	7.0x5.0
IF Filter	SF2037B	76.5	3.8	SDARS	7.0x5.0
IF Filter	SF2037B-2	76.5	3.8	SDARS	7.0x5.0
IF Filter	SF2037B-3	76.5	3.8	SDARS	7.0x5.0
Diplexer	SF2143A	72.54/80.46	4	SDARS	11.4x5.3
Diplexer	SF2143B	72.54/80.46	4	SDARS	7.0x5.0
IF Filter	SF1140B	75	4.2	SDARS	7.0x5.0
IF Filter	SF1140B-2	75	4.2	SDARS	7.0 x 5.0
IF Filter	SF1142B	315	4.2	SDARS	7.0x5.0
IF Filter	SF2026B	114.815	6.3	SDARS	7.0x5.0
IF Filter	SF2038B	76.5	12.5	SDARS	7.0x5.0
IF Filter	SF2038B-2	76.5	12.5	SDARS	7.0x5.0
IF Filter	SF2038B-3	76.5	12.5	SDARS	7.0 x 5.0
IF Filter	SF2060B	115	12.5	SDARS	5.0x7.0
IF Filter	SF2060B-1	115	12.5	SDARS	5.0x7.0
IF Filter	SF2138B	144	12.5	SDARS	7.0x5.0

SAW RF / IF Filters

IF Filter	SF2079D	251	12.5	SDARS	3.8x3.8
IF Filter	SF2024D	467.751	12.5	SDARS	3.8x3.8x1.2
IF Filter	SF2024D-1	467.751	12.5	SDARS	3.8x3.8x1.0
IF Filter	SF2024E-1	467.751	12.5	SDARS	3.0x3.0x0.9
IF Filter	SF2024E-2	467.751	12.5	SDARS	3.0x3.0x0.9
RF Filter	SF1219K	2338	12.5	SDARS	1.4x1.1
IF Filter	SF2024B	467.751	12.688	SDARS	7.0x5.0
IF Filter	SF1141B	75	12.7	SDARS	7.0x5.0
IF Filter	SF1141B-2	75	12.7	SDARS	7.0 x 5.0
IF Filter	SF1141B-4	75	12.7	SDARS	7.0 x 5.0
IF Filter	SF1143B	315	12.7	SDARS	7.0x5.0
IF Filter	SF1143B-1	315	12.7	SDARS	7.0 x 5.0
IF Filter	SF1143B-2	315	12.7	SDARS	7.0 x 5.0
IF Filter	SF1143B-4	315	12.7	SDARS	7.0 x 5.0
IF Filter	SF2025B	259.861	12.708	SDARS	7.0x5.0
RF Filter	SF1220K	2326	14	SDARS	1.4x1.1
IF Filter	SF2069A	96	4.8	TD-SCDMA	13.3x6.5
IF Filter	SF2069A-1	96	4.8	TD-SCDMA	19.0x6.5
IF Filter	SF2149A	46.08	5	TD-SCDMA	13.3x6.5
IF Filter	SF2069A-2	96	5	TD-SCDMA	13.3x6.5
IF Filter	SF2111A	140	15	TD-SCDMA	13.3x6.5
RF Filter	SF1208H	2017.5	15	TD-SCDMA	2.0x1.6
IF Filter	SF2131B	92.16	20	TD-SCDMA	7.0x5.0
IF Filter	SF1200B	96	20	TD-SCDMA	7.0x5.0
IF Filter	SF2006C	190	4.8	WCDMA	5.0x5.0
IF Filter	SF2067B	172.8	8.84	WCDMA	7.0x5.0
IF Filter	SF2140A	140	20	WCDMA/TD-SCDMA	13.3x6.5
IF Filter	SF1177A	57.6	21.2	WCDMA/TD-SCDMA	13.3x6.5
IF Filter	SF2109D	305	8.4	Wibro	3.8x3.8
IF Filter	SF2063A	156	9	Wibro	13.3x6.5
IF Filter	SF2076B	464	3.7	Wimax	7.0x5.0
IF Filter	SF2094B	380	4	Wimax	7.0x5.0
IF Filter	SF2125D	305	5	Wimax	3.8x3.8
IF Filter	SF2046B	456.44	5.22	Wimax	7.0x5.0
RF Filter	SF2065C	743	6	Wimax	5.0x5.0
IF Filter	SF2064A	156	10	Wimax	13.3x6.5
IF Filter	SF2110D	305	10	Wimax	3.8x3.8
IF Filter	SF2073B	456	10	Wimax	7.0x5.0
IF Filter	SF2042B	456	15	Wimax	5.0x7.0
IF Filter	SF2042C	456	15	Wimax	5.0x5.0
IF Filter	SF2072C	360	30	Wimax	5.0x5.0
RF Filter	SF2126E	725	50	WIMAX	3.0x3.0
RF Filter	SF1188C	465	4	Wireless Access	5.0x5.0
RF Filter	SF2008D	930.5	4	Wireless Access	3.8x3.8
IF Filter	SF1189B-1	280	17.97	Wireless Access	5.0x5.0
IF Filter	SF1174B	374	17	WLAN	5.0x5.0
IF Filter	SF1174D	374	17	WLAN	3.8x3.8

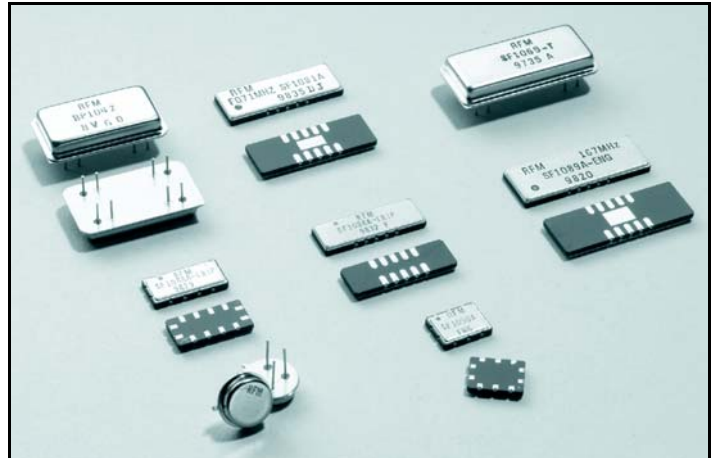

SAW-Based Frequency Control & Crystal-Based Products

RFM retains a long history of providing stable, SAW based frequency control products for computer timing, analog communications, test instrumentation and military applications. In addition, RFM manufactures optical timing products based on our patented "Diff Sine" technology to meet the increasing demand for bandwidth in communication systems. These products have been specifically developed for applications such as dense wave division multiplexing (DWDM) equipment where timing integrity and elimination of system noise in circuits are critical.

The OP4005B and OP4005B-1 are both 622.08 MHz differential clocks with near perfect symmetry and extremely low jitter with or without noise on the power planes. The OP4006B is a 666.5 MHz Clock for forward error correction timing. RFM's "Diff Sine" architecture is the basis of each of these high performance optical products.

The OPB series along with the SCB series Clocks are also used for timing on ultra high speed A to D converter applications and other digital radio applications as well. A variety of crystal based products are also available. These products are small, high performance devices used in both time and frequency domain applications.

SAW Based Frequency Control			
Product No.	Freq. (MHz)	Tol/Spec	Case
Voltage Controlled Oscillator			
HO4002-1	400	+/-0.04MHz, 0-10VDC, Low Phase Noise	DIP16-8
HO4001-1	1000	+/-0.15MHz, 0-5VDC, Low Phase Noise	DIP16-8
Optical Timing Clock			
OP4005B	622.08	+/-100ppm, 0.1ps RMS Jitter, Low Phase Noise	SMC-8
OP4005B1	622.08	+/-100ppm, 0.1ps RMS Jitter, Low Phase Noise	SMC-8A
OP4004B	625	+/-100ppm, 2ps RMS Jitter, Low Phase Noise	SMC-8
OP4014B	627.329	+/-100ppm, <1ps RMS Jitter, Low Phase Noise	SMC-8
OP4012B	644.53125	+/-100ppm, 2ps RMS Jitter, Low Phase Noise	SMC-8
OP4010B	663.552	+/-100ppm, 2ps RMS Jitter, Low Phase Noise	SMC-8
OP4006B	666.51	+/-100ppm, 2ps RMS Jitter, Low Phase Noise	SMC-8
OP4006B1	666.51	+/-100ppm, 1ps RMS Jitter, Low Phase Noise	SMC-8A
OP4007B	669.128	+/-100ppm, 2ps RMS Jitter, Low Phase Noise	SMC-8
OP4008B	669.327	+/-100ppm, 2ps RMS Jitter, Low Phase Noise	SMC-8
OP4009B	672.163	+/-100ppm, 2ps RMS Jitter, Low Phase Noise	SMC-8
OP4013B	693.48342	+/-100ppm, 2ps RMS Jitter, Low Phase Noise	SMC-8
OP4018B1	718.864	+/-50ppm, 0.5ps RMS Jitter, Low Phase Noise	SMC-8A
OP4011B	719.734	+/-100ppm, 2ps RMS Jitter, Low Phase Noise	SMC-8
OP4017B	777.6	+/-100ppm, 1ps RMS Jitter, Low Phase Noise	SMC-8
OP4017B1	777.6	+/-100ppm, 2ps RMS Jitter, Low Phase Noise	SMC-8A
OP4015B	780.881	+/-100ppm, 0.2ps RMS Jitter, Low Phase Noise	SMC-8
Diff Sine Wave Clock			
SC3044B	251	Tol = 300ppm, VCC=3.3	SMC-8
SC3041B	300	Tol = 200ppm, VCC=3.3	SMC-8
SC3037B	350	Tol = 200ppm, VCC=3.3	SMC-8
SC3017B	400	Tol = 200ppm, VCC=3.3	SMC-8
SC3040B	400	Tol = 200ppm, VCC=3.3	SMC-8
SC3048B	444	Tol = 200ppm, VCC=3.3	SMC-8
SC3019B	500	Tol = 200ppm, VCC=3.3	SMC-8
SC3038B	532	Tol = 200ppm, VCC=3.3	SMC-8
SC3015B	550	Tol = 200ppm, VCC=3.3	SMC-8
SC3011B-1	600	Tol = 250ppm, VCC=3.3	SMC-8
SC3045B	621.6	Tol = 250ppm, VCC=3.3	SMC-8
SC3042B	624	Tol = 200ppm, VCC=3.3	SMC-8
SC3056B	667	Tol = 250ppm, VCC=3.3	SMC-8B
SC3049B	700	Tol = 250ppm, VCC=3.3	SMC-8
SC3053B	750	Tol = 250ppm, VCC=3.3	SMC-8
SC3035B-1	800	Tol = 250ppm, VCC=3.3	SMC-8
SC3046B-5	933.12	Tol = 70ppm, VCC=3.3	SMC-8B

Crystal Products			
Product No.	Freq. (MHz)	Tol/Spec	Case (mm)
Crystal Filter			
XFL8001	76.8	4 kHz BW, -3dB IL, -30C to +80C	5.0x3.2
Crystal Oscillator			
XO3002	20.48	3.3V, +/- 40 ppm, -40C to +85C	7.0x5.0
XO3003	25.6	3.3V, +/- 40 ppm, -40C to +85C	7.0x5.0
XO3001	125	3.3V, +/- 50 ppm, -40C to +70C	7.0x5.0
XO3001-1	125	3.3V, +/- 50 ppm, -40C to +70C	7.0x5.0
Temp Compensated Crystal Oscillator			
XTC7003	12.8	3.0V, +/-1 ppm, -30C to +85C	5.0x3.2
XTC7004	16.367667	2.85V, +/-0.5 ppm, -30C to +85C	3.2x2.5
XTC7005	16.369	2.85V, +/-0.5 ppm, -30C to +85C	3.2x2.5
XTC7001	18.414	3.0V, +/-2 ppm, -40C to +85C	5.0x3.2
XTC7002	30	2.8V, +/-2 ppm, -30C to +85C	3.2x2.5
Voltage Controlled Temp Compensated Crystal Oscillator			
XVT9001	19.2	2.8V, +/-2.5 ppm, -20C to +70C	3.2x2.5
XVT9003	19.2	2.8V, +/-2.5 ppm, -30C to +80C	3.2x2.5
XVT9002	26	2.8V, +/-2.5 ppm, -20C to +75C	3.2x2.5
XVT9004	30	2.8V, +/-2.5ppm, -30C to +80C	3.2x2.6
XVT9005	32	2.8V, +/-2.0ppm, -30C to +85 C	3.2x2.7
XVT9006	40	2.8V, +/-2.0ppm, -30C to +85 C	3.2x2.8
Crystal Resonator			
XTL1009	8	12 pF, +/-30 ppm, -40C to +85C	5.0x3.2
XTL1001	9.84	10 pF, +/-30 ppm, -40C to +125C	5.0x3.2
XTL1005	9.84	3 pF, +/-50 ppm, -40C to +125C	5.0x3.2
XTL1002	10	12 pF, +/-20 ppm, -20C to +70C	5.0x3.2
XTL1010	12	12 pF, +/-30 ppm, -10C to +60C	5.0x3.2
XTL1020	12.8	12 pF, +/- 20 ppm, -40C to +85C	5.0x3.2
XTL1003	13.56	20 pF, +/- 50 ppm, -40C to +125C	5.0x3.2
XTL1003	13.56	12 pF, +/- 50 ppm, -40C to +125C	5.0x3.2
XTL1004	13.56	20 pF, +/-10 ppm, -20C to +70C	5.0x3.2
XTL1006	13.56	3 pF, +/-50 ppm, -40C to +125C	5.0x3.2
XTL1012	24.265	12 pF, +/-15 ppm, -40C to +85C	2.5x2.0
XTL1018	24.265	12 pF, +/- 30 ppm, -40C to +85C	2.0x1.6
XTL1008	26	16 pF, +/-10 ppm, -20C to +70C	3.2x2.5
XTL1011	26	9 pF, +/-30 ppm, -20C to +75C	3.2x2.5
XTL1013	26	10.3 pF, +/-10 ppm, -20C to +75C	3.2x2.5
XTL1017	30	20 pF, +/-15 ppm, -40C to +105C	3.2x2.5
XTL1014	48.53	8 pF, +/-30 ppm, -40C to +85C	2.5x2.0
XTL1015	48.53	10 pF, +/-30 ppm, -40C to 85C	2.5x2.0
XTL1016	48.53	12 pF, +/-30 ppm, -40C to +85C	2.5x2.0
XTL1019	48.53	12 pF, +/- 30 ppm, -40C to +85C	2.0x1.6

Subsystem RF Products

SAW-Based and RFIC Short-Range Radios

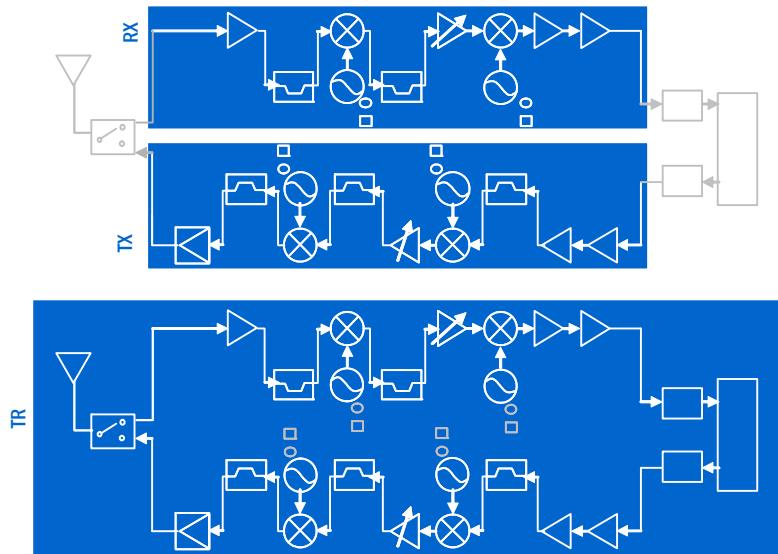

○ Crystal for Frequency Control is an external component for all RFIC products

RFM SAW-Based Radio Products include RFM 2G and 3G transceivers, transmitters, and receivers, are based on RFM ultra low power, proprietary amplifier-sequenced hybrid (ASH) radio architecture, and offer the following features:

- Integrated RF IC with quartz SAW filtering and frequency control components in a single hybrid greatly simplifying and speeding up the RF design task
- High Data rates for data, control and digitized voice transmissions
- Stable, sensitive receiver technology with excellent "channel capture" performance
- Ultra low current consumption for operation from small 3 V batteries
- Very small, low-profile package to make "watch size" applications practical
- Rugged, self-shielding, metal-ceramic hybrid package
- Wide operating temperature range for industrial and outdoor applications
- Easy to optimize for a wide range of application requirements
- Easy certification to stringent short-range radio regulatory requirements
- No external RF filters, IF filters, resonators or crystals are required

RFM RFIC Radios include PLL-based, single- or multi-channel transceivers, transmitters and receivers, evaluation boards and RF Design Assistant Software, servicing varied wireless applications in the marketplace and provide the following features:

- Integrated PLL, IF, Baseband Circuitry, thus minimizing external component count and simplifying and speeding design-ins
- Support for single- and multiple-channel applications
- Wide frequency range
- Wide operating supply voltage
- Frequency Hopping Spread Spectrum capability
- Very few external components required
- Small size plastic packages

Short-Range Radios

The SAW-based and RFIC short-range radio products are attractive to OEMs that wish to embed RF capabilities and communications within their products. These OEMs also typically possess RF engineering and networking expertise that enables them to incorporate low-power sensor networking capabilities as a feature within their product offerings, often to connect the devices they manufacture to each other and the Internet.

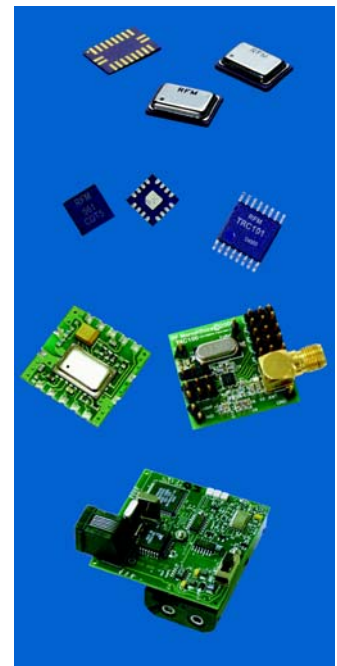

Products

- 3G Transceivers
- 2G Transceivers
- RFIC Transmitters
- RFIC Receivers
- RFIC Transceivers

Features

- 300-1000 MHz
- Data Rates up to 1Mbps
- SAW & Crystal-based
- OOK/ASK & FSK Modulation

Subsystem RF Products

SAW-Based Short-Range Radios (TR, TX, RX)

Short-Range Radios		Select by Part Number		Select Dev Kit / Eval Kit or Dev Board		
Product No.	Freq. (MHz)	Description	Case (mm)	Dev Kit	Eval Kit	Dev Board
Transmitters						
TX5000	433.92	2G ASH TX, 115.2 kbps	11x9.5			DR4100
TX5001	315	2G ASH TX, 115.2 kbps	11x9.5			DR4101
TX5002	418	2G ASH TX, 115.2 kbps	11x9.5			
TX5003	303.825	2G ASH TX, 115.2 kbps	11x9.5			DR4103
TX6000	916.5	2G ASH TX, 115.2 kbps	10x7			DR4000
TX6001	868.35	2G ASH TX, 115.2 kbps	10x7			DR4001
TX6004	914	2G ASH TX, 115.2 kbps	10x7			
Transceivers						
TR1000	916.5	2G ASH TR, 115.2 kbps	10x7	DR2000-DK		DR3300
				DR1200-DK		DR3000-1
				DR1200A-DK		DR3300
TR1001	868.35	2G ASH TR, 115.2 kbps	10x7	DR1201-DK		DR3001
				DR1201A-DK		
TR1004	914	2G ASH TR, 115.2 kbps	10x7			
TR1100	916.5	2G ASH TR, 115.2 kbps	10x7			DR3300
TR3000	433.92	2G ASH TR, 115.2 kbps	11x9.5	DR1300-DK		DR3100
				DR1300A-DK		DR3100-1
TR3001	315	2G ASH TR, 115.2 kbps	11x9.5			DR3101
TR3002	418	2G ASH TR, 115.2 kbps	11x9.5			
TR3003	303.825	2G ASH TR, 115.2 kbps	11x9.5			
TR3005	403.5	2G ASH TR, 115.2 kbps	10x7			
TR3100	433.92	2G ASH TR, 115.2 kbps	11x9.5			
TR7000	433.92	3G ASH TR, 115.2 kbps	11x7	DR7000-DK	DR7000-EV	DR7000
TR7001	315	3G ASH TR, 115.2 kbps	11x7		DR7001-EV	DR7001
TR7002	418	3G ASH TR, 115.2 kbps			DR7002-EV	DR7002
TR7003	303.825	3G ASH TR, 115.2 kbps	11x7		DR7003-EV	DR7003
TR8000	916.5	3G ASH TR, 115.2 kbps	11x7	DR8000-DK	DR8000-EV	DR8000
TR8001	868.35	3G ASH TR, 115.2 kbps	11x7	DR8001-DK	DR8001-EV	DR8001
TR8100	916.5	3G ASH TR, 115.2 kbps	11x7	DR8100-DK	DR8100-EV	DR8100
Receivers						
RX5000	433.92	2G ASH RX, 115.2 kbps	11x9.5			DR5100
RX5001	315	2G ASH RX, 115.2 kbps	11x9.5			DR5101
RX5002	418	2G ASH RX, 115.2 kbps	11x9.5			
RX5003	303.825	2G ASH RX, 115.2 kbps	11x9.5			DR5103
RX5005H	433.42	2G ASH RX, 115.2 kbps	10x7			
RX5500	433.92	2G ASH RX, 19.2 kbps	11x9.5			
RX5501	315	2G ASH RX, 19.2 kbps	11x9.5			
RX6000	916.5	2G ASH RX, 115.2 kbps	10x7			DR5000
RX6001	868.35	2G ASH RX, 115.2 kbps	10x7			DR5001
RX6004	914	2G ASH RX, 115.2 kbps	10x7			
RX6501	868.35	2G ASH RX, 19.2 kbps	10x7			

Development Kits		
DR1200-DK	916.5	2G Development Kit, 22.5 Kbps
DR1200A-DK	916.5	2G Development Kit, 22.5 Kbps
DR1201-DK	868.35	2G Development Kit, 22.5 Kbps
DR1201A-DK	868.35	2G Development Kit, 22.5 Kbps
DR1300-DK	433.92	2G Development Kit, 22.5 Kbps
DR1300A-DK	433.92	2G Development Kit, 22.5 Kbps
DR2000-DK	916.5	2G Development Kit, 115.2 Kbps
DR2001-DK	868	2G Development Kit, 115.2 Kbps

Transceiver Evaluation Modules		
DR7000-EV	433.92	3G Transceiver Evaluation Module, 4.8 Kbps
DR7001-EV	315	3G Transceiver Evaluation Module, 4.8 Kbps
DR7002-EV	418	3G Transceiver Evaluation Module, 4.8 Kbps
DR7003-EV	303.825	3G Transceiver Evaluation Module, 4.8 Kbps
DR8000-EV	916.5	3G Transceiver Evaluation Module, 4.8 Kbps
DR8001-EV	868.35	3G Transceiver Evaluation Module, 4.8 Kbps
DR8100-EV	916.5	3G Transceiver Evaluation Module, 4.8 Kbps
RF Uart Integrated Circuits		
IC1000		Data/Clock Extraction IC K04-057
IC1003		RF Uart IC VQ64

RF Modules		
Product No.	Freq. (MHz)	Description
DR3000	916.5	2G Transceiver Module, 19.2 Kbps
DR3000-1	916.5	2G Transceiver Module, 115.2 Kbps
DR3001	868.35	2G Transceiver Module, 19.2 Kbps
DR3100	433.92	2G Transceiver Module, 19.2 Kbps
DR3100-1	433.92	2G Transceiver Module, 115.2 Kbps
DR3101	315	2G Transceiver Module, 19.2 Kbps
DR3300	916.5	2G Transceiver Module, 1 Mbps
DR4000	916.5	2G Transceiver Module, 115.2 Kbps
DR4001	868.35	2G Transceiver Module, 115.2 Kbps
DR4100	433.92	2G Transceiver Module, 115.2 Kbps
DR4101	315	2G Transceiver Module, 115.2 Kbps
DR4103	303.825	2G Transceiver Module, 115.2 Kbps
DR5000	916.5	2G Transceiver Module, 19.2 Kbps
DR5001	868.35	2G Transceiver Module, 19.2 Kbps
DR5100	433.92	2G Transceiver Module, 19.2 Kbps
DR5101	315	2G Transceiver Module, 19.2 Kbps
DR5103	303.825	2G Transceiver Module, 19.2 Kbps
DR7000	433.92	3G Transceiver Module, 4.8 Kbps
DR7001	315	3G Transceiver Module, 4.8 Kbps
DR7002	418	3G Transceiver Module, 4.8 Kbps
DR7003	303.825	3G Transceiver Module, 4.8 Kbps
DR8000	916.5	3G Transceiver Module, 4.8 Kbps
DR8001	868.35	3G Transceiver Module, 4.8 Kbps
DR8100	916.5	3G Transceiver Module, 4.8 Kbps

NEW! Denotes New Product

Subsystem RF Products

RFIC Short-Range Radios

RFIC Radios		Select by Part Number		Select Dev Kit / Eval Board	
Product No.	Freq. (MHz)	Description	Case	Dev Kit	Eval Board
Transmitters					
TXC100	300-450	ASK/FSK RFIC Transmitter	3x3mm		DR-TXC100-315 DR-TXC100-433
TXC101	300-1000	OOK/FSK RFIC Transmitter	6.4x5mm	DR-TXC101-315-DK	DR-TXC101-315
TXC102	400-1000	OOK/FSK RFIC Transmitter	6.4x5mm	DR-TXC102-433-DK DR-TXC102-868-DK DR-TXC102-915-DK	DR-TXC102-433 DR-TXC102-868-915
Transceivers					
TRC101	300-1000	Multi-channel FSK	6.4x5mm	DR-TRC101-315-DK	DR-TRC101-315 DR-TRC101-433 DR-TRC101-868-915
TRC102	400-1000	Multi-channel FSK	6.4x5mm	DR-TRC102-433-DK DR-TRC102-868-DK DR-TRC102-915-DK	DR-TRC102-433 DR-TRC102-868-915
TRC103	868-915	Multi-channel FSK	6.4x5mm	DR-TRC103-868-DK DR-TRC103-868-DK-EU DR-TRC103-915-DK	DR-TRC103-868 DR-TRC103-868-EV DR-TRC103-915 DR-TRC103-915-EV
TRC104	2401-2527	Multi-channel GFSK	4x4mm	DR-TRC104-2400-DK	DR-TRC104-2400
Receivers					
RXC101	300-1000	Multi-channel FSK	6.4x5mm		DR-RXC101-315 DR-RXC101-433 DR-RXC101-868-915



TRC104 Transceiver

Evaluation Boards		
Product No.	Freq. (MHz)	Description
DR-RXC101-315	315	RFIC Evaluation Board
DR-RXC101-433	433	RFIC Evaluation Board
DR-RXC101-868-915	868-915	RFIC Evaluation Board
DR-TRC101-315	315	RFIC Evaluation Board
DR-TRC101-433	433	RFIC Evaluation Board
DR-TRC101-868-915	868-915	RFIC Evaluation Board
DR-TRC102-433	433	RFIC Evaluation Board
DR-TRC102-868-915	868-915	RFIC Evaluation Board
DR-TRC103-868	868	RFIC Evaluation Board
DR-TRC103-868-EV	868	RFIC Evaluation Board
DR-TRC103-915	915	RFIC Evaluation Board
DR-TRC103-915-EV	915	RFIC Evaluation Board
DR-TRC104-2400	2401-2527	RFIC Evaluation Board
DR-TXC100-315	315	RFIC Evaluation Board
DR-TXC100-433	433	RFIC Evaluation Board
DR-TXC101-315	315	RFIC Evaluation Board
DR-TXC102-433	433	RFIC Evaluation Board
DR-TXC102-868-915	868-915	RFIC Evaluation Board
Development Kits		
DR-TRC101-315-DK	315	RFIC Development Kit
DR-TRC102-433-DK	433	RFIC Development Kit
DR-TRC102-868-DK	868	RFIC Development Kit
DR-TRC102-915-DK	915	RFIC Development Kit
DR-TRC103-868-DK	868	RFIC Development Kit
DR-TRC103-868-DK-EU	868	RFIC Development Kit
DR-TRC103-915-DK	915	RFIC Development Kit
DR-TRC104-2400-DK	2401-2527	RFIC Development Kit
DR-TXC101-315-DK	315	RFIC Development Kit
DR-TXC102-433-DK	433	RFIC Development Kit
DR-TXC102-868-DK	868	RFIC Development Kit
DR-TXC102-915-DK	915	RFIC Development Kit



DR-TRC104-2400 Evaluation Board



DR-TRC104-2400-DK Development Kit

Ready-Made OEM RF Modules and Standalone RF Devices



Home Entertainment and Control -- smart lighting, advanced temperature control, safety & security and movies & music

Home Awareness -- water sensors, power sensors, smart appliances and access sensors



Commercial Building Automation -- building commissioning, energy monitoring, HVAC, lighting, server room, access control, device control, condition-based maintenance

Security / Public Safety -- air quality monitoring, first-responder systems, border / perimeter security, hazards materials management, water security systems, wastewater management, personal safety devices, security & alarm systems



Industrial Plant -- SCADA, process control and automation instrument calibration, asset management, environmental management, energy management, device control

Energy / Utilities -- automated meter reading, substation integration, distribution automation, utility sub-metering, oil/gas production monitoring

Supply Chain Management -- inventory monitoring, container tracking, cold-chain monitoring



Wireless Sensor Networking for Low-Power, Low Data-Rate Through-Put

RFM wireless sensor networking (WSN) products include ready-made transceiver modules and standalone (boxed) products that enable OEMs to provide low-cost wireless control and monitoring functionality in low-data rate, low-power applications that require long battery life, such as home automation, energy, telecommunication applications, and personal home and hospital care.

Standard or proprietary? RFM offers wireless sensor networking products based on two open standards ZigBee and IEEE 802.15.4 for OEMs designing very low-cost condition monitoring and control applications. RFM proprietary products are optimized specifically for low-power consumption applications and gain robustness with mesh network technology.

RFM wireless sensor networking products operate in the following industrial, scientific and medical (ISM) radio bands: **434 MHz** (accepted in Europe and China), **900 MHz** (accepted in USA, Canada, Australia, or New Zealand), or **2.4 GHz** (accepted in most jurisdictions worldwide.)

- **2.4 GHz ZigBee ZMN-series:** new single-chip ZigBee transceiver modules based on the ZigBee 2006 and come with FCC module certification. The low power-usage allows longer life with smaller batteries. The self-healing mesh networking provides high reliability and longer range. Standalone products include ZigBee Ethernet and ModBus Gateways that can function as a ZigBee network coordinator or take-out point.
- **2.4 GHz 802.15.4 LPR-series:** transceiver modules based on IEEE 802.15.4 standard and come with FCC module certification. For applications that need cost and power savings but do not require mesh networking and its attendant overhead. Provides excellent peer-to-peer and star topology wireless networking. Standalone products include 802.15.4 serial modems that serve as wireless replacement for RS-232 cables.
- **434 MHz / 916 MHz Proprietary Mesh DM18-series and DM22-series:** transceiver modules based on RFM proprietary technologies and platforms. For applications that need cost and power savings, reliable self-healing mesh networking and a simple wireless sensor network protocols.

Proprietary FHSS for Long-Range, High Data-Rate Through-Put

900 MHz and 2.4 GHz Proprietary FHSS Ready-Made RF Modules WIT-series. RFM proprietary FHSS products provide robust wireless industrial telemetry for industrial and factory environments that require radio transmission that is far more resistant to electrical noise and interference, jamming and multi-path fading than conventional radio transmission. Frequency Hopping Spread Spectrum (FHSS), originally developed for the military, is widely utilized for industrial and manufacturing device applications because it employs a technique to spread a signal over multiple frequencies to ensure reliable over-the-air transmission in under adverse conditions.

For industrial and SCADA (supervisory control and data acquisition industrial automation systems), FHSS provides greater transmission range than is afforded by such protocols as 802.11. FHSS networking is useful in outdoor applications where nodes may be separated by several miles, while ensuring fast, error-free delivery of data of up to 20 miles.

900 MHz and 2.4 GHz Proprietary FHSS Standalone RF Devices HN-, HNIO-, SNAP-, and SEM-series. RFM proprietary FHSS standalone RF devices can be paired with RFM proprietary FHSS modules or used alone for fixed wireless network applications for a wide range of indoor, outdoor, and harsh environments.

WLAN Wi-Fi (802.11b/g) and WPAN Bluetooth (802.15) for Very High Data-Rate Through-Put

2.4 GHz, Very High Data Rate WLAN 802.11b/g Ready-Made RF Modules Airborne-series. RFM enhances and offers Airborne 802.11b/g ready-made RF modules that, when embedded into product applications, enable device access to local area networks (LAN). These ready-made RF modules provide very high data rates of up to 54 Mbps and transmit distances of up to 1,000 meters. They serve as replacement for serial cables in a broad range of home, consumer, business and public wireless local area network (WLAN) applications.

2.4 GHz, 3 Mbps data rate Bluetooth Ready-Made RF Modules BlueGiga-series. RFM enhances and offers BlueGiga Bluetooth ready-made RF modules that enable connectivity and information exchange between wireless personal area network (WPAN) devices over shorter distances of up to 100 meters. These products are embedded into such devices as mobile phones, laptops, personal computers, printers, GPS receivers, digital cameras, and video-game consoles. Also, they often serve as replacement for traditional wired serial communications in GPS receivers, medical equipment, bar code scanners, and traffic control devices and are useful as controls where infrared is traditionally used.

Selecting the right Ready-Made RF Module is as easy as **ONE – TWO – THREE.**

ONE: Answer 7 key questions to identify the type of Ready-Made RF Module to fit the application requirements.

TWO: Select the part number on the following pages to identify developer kit and tools.

THREE: Go to www.RFM.com to download technical specifications information and to order a developer kit.

	1 FRE- QUENCY			2 MAX RF DATA RATE							3 RANGE								4 RF POWER				5 STANDARD			6 NETWORK			7 TECHNOL- OGY		INTER- FACE														
	434 MHz	900 MHz	2.4 GHz	4.8 K	9.6 K	172.8 K	250 K	460.8 K	500 K	1.22 M	3 M	54 M	Indoor 30 m	Indoor 100 m	Indoor >100 m	Outdoor 30 m	Outdoor 100 m	Outdoor 250 m	Outdoor 500 m	Outdoor 1,000 m	Outdoor 10,000 m	Outdoor >10,000 m	1 mW	10 mW	100 mW	250 mW	1 W	ZigBee	802.15.4	Proprietary	802.11	Bluetooth	Mesh	Multipoint	Peer-to-Peer	Narrowband	Frequency Hopping	Direct Sequence	UART Only	I/O and UART					
DM1800	✓	✓		✓								✓	✓	✓	✓	✓	✓	✓	✓	✓	✓	✓	✓				✓				✓	✓	✓	✓	✓	✓	✓	✓	✓	✓	✓	✓			
DM1810	✓	✓		✓								✓	✓	✓	✓	✓	✓	✓	✓	✓	✓	✓	✓				✓				✓	✓	✓	✓	✓	✓	✓	✓	✓	✓	✓	✓			
DM2200	✓	✓		✓								✓	✓	✓	✓	✓	✓	✓	✓	✓	✓	✓	✓				✓				✓	✓	✓	✓	✓	✓	✓	✓	✓	✓	✓	✓			
DNT900		✓							✓			✓	✓	✓	✓	✓	✓	✓	✓	✓	✓	✓	✓																			✓	✓		
DNT2400		✓							✓			✓	✓	✓	✓	✓	✓	✓	✓	✓	✓	✓	✓																				✓	✓	
LPR2430		✓										✓	✓	✓	✓	✓	✓	✓	✓	✓	✓	✓	✓				✓																✓	✓	
LPR2430A		✓										✓	✓	✓	✓	✓	✓	✓	✓	✓	✓	✓	✓				✓																✓	✓	
LPR2430ER		✓										✓	✓	✓	✓	✓	✓	✓	✓	✓	✓	✓	✓				✓																✓	✓	
LPR2430ERA		✓										✓	✓	✓	✓	✓	✓	✓	✓	✓	✓	✓	✓				✓																✓	✓	
WIT910	✓											✓	✓	✓	✓	✓	✓	✓	✓	✓	✓	✓	✓				✓																✓	✓	
WIT2410		✓										✓	✓	✓	✓	✓	✓	✓	✓	✓	✓	✓	✓				✓																✓	✓	
WIT2411		✓										✓	✓	✓	✓	✓	✓	✓	✓	✓	✓	✓	✓				✓																✓	✓	
WIT2450		✓										✓	✓	✓	✓	✓	✓	✓	✓	✓	✓	✓	✓				✓																✓	✓	
WLNG		✓										✓	✓	✓	✓	✓	✓	✓	✓	✓	✓	✓	✓																				✓	✓	
WSN802G		✓										✓	✓	✓	✓	✓	✓	✓	✓	✓	✓	✓	✓				✓																	✓	✓
WT11		✓										✓	✓	✓	✓	✓	✓	✓	✓	✓	✓	✓	✓				✓																	✓	✓
WT12		✓										✓	✓	✓	✓	✓	✓	✓	✓	✓	✓	✓	✓				✓																	✓	✓
WT32		✓										✓	✓	✓	✓	✓	✓	✓	✓	✓	✓	✓	✓				✓																	✓	✓
XDM2140		✓										✓	✓	✓	✓	✓	✓	✓	✓	✓	✓	✓	✓				✓																	✓	✓
ZMN2405		✓										✓	✓	✓	✓	✓	✓	✓	✓	✓	✓	✓	✓				✓																	✓	✓
ZMN2405HP		✓										✓	✓	✓	✓	✓	✓	✓	✓	✓	✓	✓	✓				✓																	✓	✓
ZMN2430		✓										✓	✓	✓	✓	✓	✓	✓	✓	✓	✓	✓	✓				✓																	✓	✓
ZMN2430A		✓										✓	✓	✓	✓	✓	✓	✓	✓	✓	✓	✓	✓				✓																	✓	✓
ZMN2430HP		✓										✓	✓	✓	✓	✓	✓	✓	✓	✓	✓	✓	✓				✓																	✓	✓
ZMN2430HPA		✓										✓	✓	✓	✓	✓	✓	✓	✓	✓	✓	✓	✓				✓																	✓	✓

* Modules can be software configured for lower rates.

Product Selector Tool
7 Key Questions to Identify the Right Ready-Made RF Module for the Application

- 1 Frequency:** If the product application will be offered in many countries 2.4 GHz modules provide a single solution for all markets. If the product will be marketed in:
 - N. or S. America choose from 916 MHz or 2.4 GHz
 - Europe or China choose from 434 MHz or 2.4 GHz
 - Japan or Korea choose from 2.4 GHz
 - China, Australia, New Zealand choose from 434 MHz, 916 MHz, or 2.4 GHz
- 2 Data rate and Range:** Does the application require low, medium, or high data through put? Over what indoor or outdoor distance is data to be transmitted?
- 3 RF Power:** Is long battery life or transmission distance primarily important? The lower the RF power - the longer the battery life. The longer the transmission range – the higher the RF power required to transmit over extended ranges. Also, is the application to be powered by main or by battery? If battery-powered, then obtaining the lowest power is important.
- 4 Standards:** If standards-compatible products or standards-based wireless communications is important for the product application then choose ZigBee, 802.15.4, 802.11b/g or Bluetooth. If lowest power is most important choose proprietary mesh. If highest resistance to interference is most important choose proprietary FHSS.
- 5 Network Topology:** If the application requires a decentralized network topology where if a node fails it will dynamically find and re-route the data (like the Internet), then choose mesh. Further, if in a mesh network topology the application requires devices to be mobile, then choose RFM proprietary mesh. Choose point-to-point or point-to-multi-point network topology if a centralized network topology bearing very low attendant overhead costs is most important.
- 6 Technology:** If the product application primarily operate where:
 - long-range and/or high data-rate transmission within adverse conditions (e.g., industrial), FHSS provides secure and highly reliable RF transmission that is resistant to interference
 - high data-rate transmission, particularly for Ethernet LAN, 802.11b/g provides wireless communications for data rates of 54 Mbps
 - a balance between data rate and power consumption is important, 802.15.4 and ZigBee technology provide rapid synchronization, moderate interference robustness and a good data rate-to-power consumption ratio
 - low power consumption is required to support battery operation in sensor networks or low traffic serial communications, the proprietary mesh modules are the best choice
- 7 Sensors / Serial Connections or UART / I/O Interface:** Does the application need direct connection to sensors or to serial devices OR both?

Ready-made RF Modules and Standalone Devices

Optimized for direct connection with:
Standard
Network Topology*
Technology
Frequency
Data Rate (K=Kpbs; M=Mpbs)
RF Power
Range Indoor
Range Outdoor
Size
Interface

*P2P = Peer-to-Peer
MP = Multipoint or Star

Wireless Networking to Meet LOW POWER with LOW TO MEDIUM DATA THROUGH PUT Application Requirements

Wireless LOW

OEM MODULES • MODBUS & ETHERNET GATEWAYS • SERIAL MODEMS

OEM MODULES • SERIAL TO

Sensors	Serial Connections	Sensors OR Serial	Serial Connections
Proprietary	802.15.4	ZigBee	Proprietary
Mesh	MP and P2P	Mesh	MP
Narrowband	DSSS	DSSS	FHSS
434MHz / 900MHz	2.4GHz	2.4GHz	900MHz / 2.4GHz
4.8K / 9.6K	250K	250K	172.8K – 1.22M
1mW / 10mW	1mW / 100mW	1mW / 100mW	100mW – 1W
100M	30M / 100M	30M / 100M	>100M
100M / 1,000M	100M / 1,000M	100M / 1,000M	10,000M +
<2 sq in / <6 sq in	<2 sq in	<2 sq in	<6 sq in / >6 sq in
I/O & UART	UART ONLY	I/O & UART	UART ONLY

Network with WIT for Extended Reach and Higher Data Through Put

OEM Equipment Embedded with

DM Mesh Module

DM1800
DM1810
DM2200

OEM Equipment Embedded with

802.15.4 Module

LPR2400
LPR2400ER
LPR2400ERA

OEM Equipment Embedded with

ZigBee Module

ZMN2405
ZMN2405HP
ZMN2405HPA
ZMN2430
ZMN2430HP
ZMN2430HPA

OEM Equipment Embedded with

FHSS Module

WIT910
WIT2410
WIT2411
WIT2450

NEW! Single Chip for Extended Battery Life Higher Sensor Resolution

Ready-to-Use (Boxed) and Standalone Devices for Systems Integration

802.15.4 Wireless replacement for RS-232 cable

802.15.4 Serial Modem

ZN-241G
ZN-241GSK
ZN-241GI
ZN-241GU

Connect to ModBus PLC or Ethernet Automation Network

Ethernet or Modbus Gateway

Functions as ZigBee network coordinator / takeout point

ZG-2400E
ZG-2400M

HN-Series Wireless Serial M

Long-range SCADA Serial Modem for 900 MHz WIT Modules

Indoor / Outdoor
HN-291
HN-291D

Indoor / Desktop
HN-591

Indoor / Outdoor
HN-210
HN-210I
HN-211F
HN-250

Indoor
HN-510
HN-550
HN-151I

Outdoor
HN-101I
HN-201I
HN-301I

Fully Compatible Wireless Network

Industrial Telemetry to Meet SCADA and Other
WIDE RANGE or HIGH DATA THROUGH PUT
 Application Requirements

ETHERNET ACCESS POINTS • ETHERNET BRIDGES • SERIAL MODEMS • I/O MODEMS

WIT910	WIT2410	WIT2411	WIT2450
900MHz	2.4GHz	900MHz	2.4GHz
172.8K	460.8K	1.23M	460.8K
1W	10/100mW	10/100mW	40/100/250mW

Connect SCADA, PLC, and industrial automation applications quickly via **FHSS** modems designed for WIT modules

Modems

Industrial Remote and SCADA I Modems for z WIT Modules

SNAP Wireless Serial to Ethernet Access Points
 Serves as base station for WIT-series Modules and HN-series Modems

SNAP910 D / X / DX
 SNAP2400 D / X / DX
 SNAP2411 D / X / DX

Eliminates need for remote devices to handle the TCP/IP protocol

HNIO Wireless Analog / Relay I/O Modems
 Connection for WIT-series Modules and HN-series Modems

Analog / Digital I/O Modems relay key levels of sensor data
 HNIO-091A
 HNIO-241A

Relay I/O Modems control state of equipment
 HNIO-091R
 HNIO-241R

SEM Wireless Spread Spectrum Ethernet Bridge
 Combine P2P MP with Cirronet repeaters to extend coverage

SEM910 D / X / DX
 SEM2400 D / X / DX
 SEM2410 D / X / DX
 SEM2411 D / X / DX
 SEM5811 D / X / DX

HS bridge between two 10/100BaseT Ethernet networks

Connect Ethernet base station and multiple Ethernet remote modems

Wireless Data or Audio Networking to Meet
VERY HIGH DATA THROUGH PUT

OEM MODULES • MODEMS • ACCESS SERVER

Serial Connections	Serial Connections
802.11b/g	Bluetooth
MP & P2P	MP & P2P
DSSS	FHSS
2.4GHz	2.4GHz
54M	3M
100mW	1.5mW / 40mW
100M	30M* (WT12 / WT32)
1,000M	100M* (WT11)
<6 sq in	<2 sq in
UART ONLY	*Indoor Range I/O & UART
OEM Equipment Embedded with Airborne™ Technologies 802.11b/g Wireless LAN Module	OEM Equipment Embedded with BlueGiga™ Bluetooth Module
	WT11 WT12 WT32 WRAP THOR 2291 2293

NEW! WT32

802.11b/g Wireless Ethernet Data Modem
 Combine with 802.11b/g Wireless LAN Module for a "Drop-in" Web-enabled WIFI Solution

WRAP THOR Wireless Access Server
 Network Bluetooth end devices into non-Bluetooth networks

ark Systems WIT, HN, SNAP, HNIO, SEM

OEM RF Modules and Standalone Devices

Low-Power Wireless Sensor Networking - Mesh 2.4 GHz

ZigBee OEM RF Modules, Dev Kits, and Gateways

Low power and low cost, RFM ZigBee radio solutions are perfect for home, commercial, and industrial applications, operating from -40°C to +85°C.

Every ZigBee module from RFM comes with FCC, IC and ETSI module certification. This means FCC type acceptance testing is not required for devices into which the OEM RF modules are integrated, saving you money and getting your product to market faster.

OEM Modules

A low-cost, low-power ZigBee module from RFM is ideal for low data rate, wireless applications, including sensor monitoring, building and home automation, and any other applications requiring low power consumption. These 2.4 GHz OEM modules come in 1 mW (ZMN2405/ZMN2430) transmit power versions for short-range applications and in 10/100 mW (ZMN2405HP/ZMN2430HP) versions for applications needing extended range or high resistance to multipath fading. Zigbee mesh networking makes these modules well suited to industrial and factory environments.

RFM ZigBee modules can be installed like integrated circuits. Even though they are complete OEM modules, they are reflow soldered to the host PCBs—there is no need for expensive, unreliable connectors. With its small footprint, there is no size penalty associated with the convenience of a module. RFM has relied on its experience in helping hundreds of OEMs integrate RFM modules to create a full set of development and configuration tools.

- **Ad hoc mesh network** — Redundant, self-forming, self-healing network
- **Low cost** — Extends wireless to virtually any sensor
- **Low power consumption** — Ideal for battery operation
- **Small size, light weight** — Easy to integrate
- **Direct sequence spread spectrum** — Fast acquisition time

ZigBee OEM Modules				
Product No.	Frequency	Transmit Power	Channels	Data Rate
ZMN2405	2.4 GHz	1 mW	16	250 Kbps
ZMN2405HP	2.4 GHz	10/100 mW	15	250 Kbps
ZMN2405HPA	2.4 GHz	10/100 mW	15	250 Kbps
ZMN2430	2.4 GHz	1 mW	16	250 Kbps
ZMN2430A	2.4 GHz	1 mW	16	250 Kbps
ZMN2430HP	2.4 GHz	10/100 mW	15	250 Kbps
ZMN2430HPA	2.4 GHz	10/100 mW	15	250 Kbps

When ordering add the letter to the part number to specify for Coordinator (-C), End Device (-E) or Router (-R)

ZigBee Development Kits	
Product No.	Description
ZMN2405HPDK-B	Basic development kit for the ZMN2405HP/ZMN2430HP module including one RS-232 serial modem, one development board, demonstration software, power supplies, antennas, and batteries
ZMN2405HPDK	Development kit for the ZMN2405HP/ZMN2430HP module including two development boards, demonstration software, power supplies, antennas and batteries
ZMN2405HPDKPro	Development kit for the ZMN2405HP/ZMN2430HP module with four remote boards and one serial gateway board, demonstration software, power supplies, antennas and batteries
ZMN2405DK	Development kit for the ZMN2405/ZMN2430 module including two development boards, demonstration software, power supplies, antennas and batteries
ZMN2405DKPro	Development kit for the ZMN2405/ZMN2430 module with four remote boards and one serial gateway board, demonstration software, power supplies, antennas and batteries

ZigBee Gateways				
Product No.	Frequency	Transmit Power	Channels	Data Rate
ZG-2400E Ethernet Gateway	2.400-2.4835	10/100 mW	15	250 Kbps



Denotes New Product

* Release date pending. Check for availability.

Low-Power Wireless Sensor Networking - P2P or MP 2.4 GHz

802.15.4 LPR OEM RF Modules, Dev Kits, and Modems

For 2.4 GHz applications that need cost and power savings but do not require mesh networking with its attendant overhead, RFM 802.15.4 1 mW LPR2430 modules and 10/100 mW LPR2430ER modules provide excellent peer-to-peer and star topology wireless networking in office and commercial applications.

Every LPR module from RFM comes with FCC, IC and ETSI module certification. This means FCC type acceptance testing is not required for devices into which the OEM modules are integrated, saving you money and getting your product to market faster.

OEM Modules

Each RFM 802.15.4 LPR module can be installed like an integrated circuit, with reflow soldering to the host PCBs—there is no need for expensive, unreliable connectors.

A RFM Networking Layer eases integration and adds support for sophisticated networks through a simple-to-use command language.

- **Peer-to-peer and star topology networking** — Use as simple cable replacement or a sophisticated network
- **RFM Networking Layer** — Eases integration and network configuration
- **Low cost** — Extends wireless to virtually any sensor
- **Low power consumption** — Ideal for battery operation
- **Small size, light weight** — Easy to integrate
- **Direct sequence spread spectrum** — Fast acquisition time
- **FCC certified for unlicensed operation** — Shortens time to market

Standalone Products

The RFM 802.15.4 wireless data modem can provide an auto-configured, wireless replacement for RS-232 cable in office environments, and can also serve as a platform for multi-drop RS-485 networks in industrial settings.

802.15.4 OEM Modules				
Product No.	Frequency	Transmit Power	Channels	Data Rate
LPR2430	2.4 GHz	1 mW	16	250 Kbps
LPR2430A	2.4 GHz	1 mW	16	250 Kbps
LPR2430ER	2.4 GHz	10/100 mW	15	250 Kbps
LPR2430ERA	2.4 GHz	10/100 mW	15	250 Kbps

Development Kits	
Product No.	Description
LPR2430DK	Development kit including four LPR2430 modules, two development boards, cables, demonstration software, power supplies, antennas, and batteries
LPR2430ADK	Development kit including four LPR2430A modules, two development boards, cables, demonstration software, power supplies, antennas, and batteries
LPR2430ERDK	Development kit including four LPR2430ER modules, two development boards, cables, demonstration software, power supplies, antennas, and batteries
LPR2430ERADK	Development kit including four LPR2430ERA modules, two development boards, cables, demonstration software, power supplies, antennas, and batteries

802.15.4 Modems				
Product No.	Frequency	Transmit Power	Channels	Data Rate
ZN-241G (Standalone RS-232 serial 802.15.4 modem providing 100mW transmit power with included 2dB dipole antenna)	2.4 GHz	10/100 mW	15	250 Kbps
ZN-241GSK (Starter kit including 2 ZN-241Gs, 2 2dB dipole antennas, 2 power supplies, 2 serial cables and Windows-based configuration utility)	2.4 GHz	10/100 mW	15	250 Kbps
ZN-241GI (Same as ZN-241G but with half-duplex RS-485 interface and screw terminal connections for serial data and power supply)	2.4 GHz	10/100 mW	15	250 Kbps
ZN-241GU (Same as ZN-241G but with a USB interface)	2.4 GHz	10/100 mW	15	250 Kbps
ZN-241G-OEM (10 Pack of the ZN-241G without antenna, power supply or serial cable)	2.4 GHz	10/100 mW	15	250 Kbps
ZN-241GIOEM (10 Pack of the ZN-241GM without antenna or power supply)	2.4 GHz	10/100 mW	15	250 Kbps
ZN-241GUOEM (10 Pack of the ZN-241GU without antenna, power supply, or USB cable)	2.4 GHz	10/100 mW	15	250 Kbps

Low-Power Wireless Sensor Networking - Mesh 434 / 916 MHz

Proprietary Mesh OEM RF Modules

RFM offers two low-cost, low-power, proprietary mesh technologies and platforms.

DM1800 and DM1810 (434 MHz or 916 MHz)

The DM1800 and DM1810 are based on the RFM proprietary miniMESH protocol. The routing software used in miniMESH has been field-proven in applications for more than a decade. Characterized by low-latencies, miniMESH supports 15 routers and 1,000 nodes. DM modules provide long battery runtime through their low operating current and the ability to sleep all the nodes in the networks, including the routers and base station.

Using simple installation guidelines, DM1800 and DM1810 products provides self-healing mesh network performance including mobile field node support and built-in network connectivity diagnostics.

- **DM1800:** These modules provide serial I/O, a 10-bit ADC input, a digital input and a digital output with 1 mW transmit power and miniMESH protocol with support for up to 7 routers. DM1800-434 Modules: ETSI certified for European applications. DM1800-916 Modules: FCC certified for US applications.
- **DM1810:** These modules provide serial I/O, a 10-bit ADC input, a digital input and a digital output with 10 mW transmit power and miniMESH protocol with support for up to 15 routers. DM1810-434 Modules: ETSI certified for European applications. DM1810-916 Modules: FCC certified for US applications and IC certified for Canadian applications.
- **IM1800:** Base station application interface board for DM1800 or DM1810 series modules.
- **IM1800-1:** Field node or router application interface board for DM1800 or DM1810 series modules.

DM2200 (434 MHz or 916 MHz)

The DM2200 is based on the RFM proprietary VersaMESH protocol that allows the functionality of all remote nodes to be adjusted for optimum performance after network installation or expansion. VersaMESH automatically selects alternate message routing when a primary route fails. Master beacons, remote status messages and built-in node connectivity indications simplify network diagnostics and maintenance.

Distinguished by its sleeping router capability and unlimited number of routers, the DM2200 module is well-suited for applications requiring all nodes to be battery powered and/or mobile. These modules provide serial I/O, 10 configurable I/O ports with 7 configurable as 12-bit ADC inputs and all 10 configurable as digital I/O, 10 mW transmit power and VersaMESH protocol.

- **DM2200-434VM Module:** ETSI certified for European applications. RoHS components and assembly.
- **DM2200-916VM Module:** FCC certified for US applications.
- **DM2200-916VM-1 Module:** Same as DM2200-916VM but with RoHS components and assembly. Recommended for new designs.
- **IM2200:** Application interface module for DM2200 modules providing I/O terminal blocks, logic level, RS232 and USB serial interfaces, 2 Form-C 1 A relay outputs.
- **IM2200-1:** Same as IM2200 but with RoHS components and assembly. Recommended for new designs.

DM1800 & DM1810 Modules (4800 bps)				
Product No.	Frequency	Transmit Power	Channels	Data Rate
DM1800-434M	434 MHz	1 mW	1	4800 bps
DM1800-916M	916 MHz	1 mW	1	4800 bps
DM1810-434M	434 MHz	10 mW	1	4800 bps
DM1810-916M	916 MHz	10 mW	1	4800 bps
IM1800	Interface module for the DM1800/DM1810 module providing USB interface, power connector, I/O terminal block and prototyping area. RoHS compliant			
IM1800-1	Interface module for the DM1800/DM1810 module providing RS-232 and USB interfaces, power connector, I/O terminal block and prototyping area. RoHS compliant			
When ordering add the letter to the part number to specify for Base Station (B), Field Node (N) or Router (R)				

DM1800 & DM1810 Packaged Routers	
Product No.	Description
DM1800-434MR-P	Plastic packaged enclosed DM1800-434 router module with covered helical antenna and power supply
DM1800-916MR-P	Plastic packaged enclosed DM1800-916 router module with covered helical antenna and power supply
DM1810-434MR-P	Plastic packaged enclosed DM1810-434 router module with covered helical antenna and power supply
DM1810-916MR-P	Plastic packaged enclosed DM1810-916 router module with covered helical antenna and power supply
*1) When ordering add one of the following letters to the part number to specify: A for AC power supply; or B for battery pack power supply 2) Then add one of the following letter to the part number to specify: H for horizontal installation (antenna is at a right angle to top of case) or V for vertical installation (antenna is parallel to top) For example, a packaged DM1810 916MHz router with an AC power supply and a vertical antenna would be ordered as DM1810-916MR-PAV	

DM2200 Modules (9600 bps)				
Product No.	Frequency	Transmit Power	Channels	Data Rate
DM2200-434VM	434 MHz	10 mW	1	9600 bps
DM2200-916VM	916 MHz	10 mW	1	9600 bps
DM2200-916VM-1	916 MHz	10 mW	1	9600 bps
IM2200	Interface module for the DM2200 module providing I/O terminal blocks, 2 Form C relays, RS-232, USB and logic level UART interfaces.			
IM2200-1	RoHS compliant interface module for the DM2200 module providing I/O terminal blocks, 2 Form C relays, RS-232, USB and logic level UART interfaces			

Development Kits	
Product No.	Description
DM1810-434-DK	Development kit for the DM1810-434 module with 1 base station and 3 field node modules, 3 router modules, 1 IM1800 and 3 IM1800-1 interface boards, cables, demonstration software, 3 battery packs and 3 power supplies.
DM1810-434-QK	"Quick" development kit for the DM1810-434 module with 1 base station module, 1 router module, 2 field node modules, 1 IM1810 interface board, and demonstration software.
DM1810-916-DK	Development kit for the DM1810-916 module with 1 base station and 3 field node modules, 3 router modules, 1 IM1800 and 3 IM1800-1 interface boards, cables, demonstration software, 3 battery packs and 3 power supplies.
DM1810-916-QK	"Quick" development kit for the DM1810-916 module with 1 base station module, 1 router module, 2 field node modules, 1 IM1810 interface board, and demonstration software.
DM2200-434-DK	Developer's Kit for the DM2200-434VM module with 1 base station module, 3 field node modules, 4 IM2200-1 interface boards, cables, demonstration software, 4 battery packs and 4 power supplies.
DM2200-916-DK	Developer's Kit for the DM2200-916VM module with 1 base station module, 3 field node modules, 4 IM2200-1 interface boards, cables, demonstration software, 4 battery packs and 4 power supplies.

Low-Power Wireless Sensor Networking - Mesh 2.4 GHz

Wireless Mesh OEM RF Modules

XDM2140 2.4 GHz Ultra Low Power Mesh Transceiver Module

Based on DUST Networks' SmartMesh-XD™ technology, RFM's XDM2140 module is designed to provide excellent communications reliability and long battery life in a wide range of sensor network applications. The XDM2140's combination of an IEEE802.15.4 transceiver and Time Synchronized Mesh Protocol (TSMP) blends the reliability of self-organizing and self-healing mesh networking with synchronized power duty cycling to achieve very long battery life operation. The XDM2140 is tailored for use in battery and line powered wireless devices for applications that require proven performance and scalability. The multifunctional interface of the XDM2140 gives it the flexibility to be used in a wide variety of applications, from energy management to building control to machine health monitoring. The XDM2140 requires no embedded programming, greatly reducing the development time and cost of a wireless sensor network application. The XDM2140 is certified for unlicensed operation in the USA, Canada and Europe. The XDM2140 complies with Directive 2002/95/EC (RoHS)

Ultra Low Power Consumption

- Innovative radio design consumes 80% less power in receive mode than competing solutions
- Ultra-efficient power usage, enabled through SmartMesh Intelligent Network management, delivers over a decade of network operation on two AA batteries
- Automatic network-wide coordination for efficient power usage

Ultra Reliable Networking

- SmartMesh-XD™ protocol delivers greater than 99.9% typical network reliability
- Frequency hopping provides interference rejection and minimizes multipath fading
- Mesh networking provides built-in redundancy
- Every XDM2140 acts as both an endpoint and a router, increasing network reliability with mesh-to-the edge™
- Automatic self-organizing mesh networking capability built in

Easy Integration

- XDM2140 provides all the module functionality with no embedded programming or complex configuration requirements
- XDM2140 interfaces is well designed and multi-functional
- High-level Data Link Control (HDLC) serial interface includes bi-directional flow control
- Industrial temperature range -40 to +85 °C
- XDM2140P version for plug in installation, XDM2140C version for solder reflow

XDM2140 Transceiver Modules				
Product No.	Frequency	Transmit Power	Channels	Data Rate
XDM2140C	2.4 GHz	10 mW	15	250 Kbps
XDM2140P	2.4 GHz	10 mW	15	250 Kbps
XDM2140P version for plug in installation, XDM2140C version for solder reflow				

Development Kits	
Product No.	Description
XDM2140DK	Development kit for the XDM2140 module including 4 XDM2140 modules, 4 XDM2140 development boards, 1 XG2400E gateway, 1 Ethernet and 5 Serial cables, 9V batteries and wall-mount power supplies, Antennas and RF cables, Program CD with software, manuals, and Quick Start Guide

Gateways				
Product No.	Frequency	Transmit Power	Channels	Data Rate
XG2400E	2.4 GHz	10 mW	15	250 Kbps

Long-Range Wireless Industrial Telemetry

Proprietary FHSS (Frequency Hopping Spread Spectrum) OEM RF Modules & Dev Kits

FHSS offers greater transmission range than is afforded by 802.11 making these products appropriate for outdoor applications where nodes may be separated by several miles. RFM FHSS modules have demonstrated 20+ mile range with omni-directional antennas, and are ready to integrate into your product application providing fast, robust, and secure communications. And their fast, error-free delivery of data makes them popular in mission-critical applications.

WIT (900 MHz – 2.4 GHz)

RFM WIT-series wireless FHSS products are especially well-suited to industrial and factory settings, where they ensure long-range data throughput despite electrical noise and multipath fading and can be configured in point-to-point and point-to-multipoint network topologies.

WIT modules operate in either a TDMA mode with dynamic, automatic bandwidth allocation support up to 62 remotes or a CSMA mode that supports up to 1024 remotes. The TDMA mode is used where guaranteed bandwidth and latency are required. The CSMA mode is used where large numbers of remotes are needed. Latencies of the TDMA mode are as low as 5 msec.

2.4GHz modules have a variety of hopping patterns allowing them to avoid interfering with 802.11 radios and meeting various countries' regulatory requirements. 900MHz modules provide limited spectrum options to support Australian and New Zealand regulatory requirements.

WIT modules consume a sufficiently low amount of power to allow 8+ hours of battery operation.

Errorless data reception is further assured by CRC error checking and ARQ (automatic repeat-request) schemes for auto-retransmission of bad packets.

FCC Certified Modules

RFM WIT modules are FCC certified so designs that incorporate these modules need not repeat type approval. RFM FHSS modules are deployed in factory automation, supervisory control and data acquisition (SCADA), medical telemetry, mining vehicle control, and fleet management applications.

WIT 900 MHz Modules (WIT910)

- **High-speed wireless data** — Up to 172.8 Kbps data rate for extended range applications such as SCADA.
- **Superior transmission range** — 1000' indoors; 20+ miles outdoors with omni-directional antennas.
- **Network flexibility** — Point-to-point and point-to-multipoint networks enable highly flexible network deployments.
- **Store-and-forward repeating** — Forwards data meant for another module while also acting as an end device.

WIT 2.4 GHz Modules (WIT2410, WIT2411, WIT2450)

- **High-speed wireless data** — Up to 1.23 Mbps throughput serves virtually any data need.
- **Superior transmission range** — 900' indoors; over 5 miles outdoor range with gain antennas.
- **Globally license-free operation** — 2.4GHz WIT OEM modules operate in the 2.4 GHz industrial, scientific, and medical (ISM) band.

FHSS Modules				
Product No.	Frequency	Transmit Power	Channels	Data Rate
WIT910M	900 MHz	10/100mW/1W	54	172.8 Kbps
WIT2450M2	2.4 GHz	40/100/250 mW	95	460.8 Kbps
WIT2410M4G	2.4 GHz	10/100mW	75	460.8 Kbps
WIT2410S4G	2.4 GHz	10/100mW	75	460.8 Kbps
WIT2411D	2.4 GHz	10/100mW	43	1.23 Mbps

FHSS Development Kits	
Product No.	Description
WIT910DK	WIT910 Developer Kit containing 2 HN-591 units each with flow control indicators, RS-232 interface, battery pack, power supply and dipole antenna, plus 2 WIT910M modules, RF cables, antennas and programming software.
WIT2410DK	WIT2410 Developer Kit containing 2 WIT2410 evaluation units each with flow control indicators, RS-232 interface, battery pack, power supply and dipole antenna, plus 2 WIT2410M4G modules, RF cables, antennas and programming software.
WIT2410SDK	WIT2410 Developer Kit containing 2 WIT2410 evaluation units each with flow control indicators, RS-232 interface, battery, power supply and dipole antenna, plus 1 SNAP2410 10BaseT access point, 2 WIT2410M4G modules, RF cables, antennas and programming software.
WIT2411DK	WIT2411 Developer Kit containing 2 HN-511 units each with flow control indicators, RS-232 and USB interfaces, battery, power supply and dipole antenna, plus 2 WIT2411 modules, RF cables, antennas and programming software.
WIT2411SDK	WIT2411 Developer Kit containing 2 HN-511 units each with flow control indicators, RS-232 and USB interfaces, battery, power supply and dipole antenna, plus 1 SNAP2411 10BaseT access point, 2 WIT2411 modules, RF cables, antennas and programming software.
WIT2450DK	WIT2450 Developer Kit containing 2 HN-550 units each with flow control indicators, RS-232 interface, battery pack, power supply and dipole antenna, plus 2 WIT2450M2 modules, RF cables, antennas and programming software.

Long-Range Wireless Industrial Telemetry

Proprietary FHSS (Frequency Hopping Spread Spectrum) RF Modules & Dev Kits

DNT900 900 MHz Frequency Hopping Multi-Function Module

The DNT900 series transceivers provide highly reliable wireless connectivity for either point-to-point or point-to-multipoint applications. Frequency hopping spread spectrum (FHSS) technology ensures maximum resistance to multipath fading and robustness in the presence of interfering signals, while operation in the 900 MHz ISM band allows license-free use in the US, Canada, South America, Israel, Australia and New Zealand. The DNT900 supports all standard serial data rates for host communications from 1.2 to 460.8 kb/s. On-board data buffering and an error-correcting air protocol provide smooth data flow and simplify the task of integration with existing applications. Key DNT900 features include:

- Multipath fading resistant frequency hopping technology with up to 50 frequency channels (902 to 928 MHz).
- Selectable 1, 10, 100, 250, 500 or 1000 mW transmit power with a firmware interlock of 85 mW maximum for 500 kb/s operation.
- Support for point-to-point or point-to-multipoint applications.
- AES encryption provides protection to eavesdropping
- FCC 15.247 certified for license-free operation.
- Nonvolatile memory stores DNT900 configuration when powered off
- 40 mile plus range with omni-directional antennas (antenna height dependent).
- Dynamic TDMA slot assignment that maximizes throughput and CSMA modes that maximizes network size.
- Transparent ARQ protocol with data buffering ensures data integrity
- Simple serial interface handles both data and control at up to 460.8 kb/s

XDM2140 Transceiver Modules				
Product No.	Frequency	Transmit Power	Channels	Data Rate
DNT900	900 MHz	1 mW to 1 W	50	38.4 to 500 Kbps
DNT2400	2.4 GHz	1 mW to 100mW	50	38.4 to 500 Kbps



Development Kits	
Product No.	Description
DNT900DK	<p>Kit Contains</p> <ul style="list-style-type: none"> • Two DNT900P radios installed in DNT900 interface boards (labeled Base and Remote) • Two 2 dBi dipole antennas with two U.FL coaxial jumper cables • Two 9 V wall-plug power suppliers, 120/240 VAC, plus two 9 V batteries (not shown above) • Two RJ-45/DB-9F cable assemblies, one RJ-11/DB-9F cable assembly, two A/B USB cables • One DNT900DK documentation and software CD
DNT2400DK	<p>Kit Contains</p> <ul style="list-style-type: none"> • Two DNT2400 modules with pins • Two DNT2400 development boards • Two USB and 2 Serial Cables • 9V Batteries and Wall-mount Power Supplies • Antennas and RF Cables • Program CD with software and manuals • Quick Start Guide



Long-Range Wireless Industrial Telemetry

Proprietary FHSS Modems

HN-series Wireless Modems (900 MHz – 2.4 GHz)

Built on the RFM WIT-series OEM modules, the versatile RFM HN-series wireless modems employ the RFM proprietary FHSS and are well-suited for any industrial or commercial application needing complete, reliable, long-range, serial modems. Whether paired with RFM WIT-series OEM modules or used standalone, HN wireless modems are ideal for fixed wireless network applications in a range of indoor, outdoor, and harsh environments.

They are available in 900 MHz and 2.4 GHz versions, support data rates of 172.8 Kbps to 1.23 Mbps, are Class I Div 2 certified, and support Modbus, DNP3, and DF1 protocols. HN wireless modems come in a variety of enclosures including NEMA 4X and I.P. 66 rated enclosures with an effective operating temperature range of -30°C to +70°C.

900 MHz Modems

The HN-591 desktop wireless modems are right at home in the relative comfort of a plant foreman's office, while the HN-291 modems deliver indoor / outdoor SCADA flexibility.

2.4 GHz Modems

In addition to SCADA applications, RFM HN-210, 211, 214, 250, 510, 550, 1010, and 1510 modems are ideal for use with industrial remote controls. Each HN-D Series is a DIN rail mount, low-cost modem with a remote mounted radio in a NEMA 4X/ I.P.66 enclosure with an internal 6dB patch antenna or with a reverse TNC antenna connector. A standard RS-232 interface connects to the device to be networked. The 2.4 GHz HN-series radios have over-the-air data rates of 460.8 kbps or 1.23 Mbps.

RFM HN-1010, 2010, and 3010 modems are equally at home in a more challenging or dangerous industrial setting. Each features a rugged NEMA 4X- and IP 66-rated enclosure suitable for a variety of tough operating environments.

Combining HN-series Wireless Modems with SNAP Serial to Ethernet Access Points

Add SNAP Wireless Serial to Ethernet Access Points as a base station for both WIT OEM modules and HN modems, which allow non-Ethernet serial devices to operate as nodes on an Ethernet network.

900MHz 172.8Kbps Long Range HN-91 Series Standalone Wireless Modems				
Product No.	Frequency	Transmit Power	Channels	Data Rate
All HN-91 Series products are based on the WIT910 and can be used as base stations. All features and modes of the WIT910 are supported in the HN-series products.				
HN-291	900 MHz	1 W	54	172.8 Kbps
HN-291X	900 MHz	1 W	54	172.8 Kbps
HN-591	900 MHz	1 W	54	172.8 Kbps

2.4GHz 460.8Kbps Low Cost HN-50 Series Standalone Wireless Modems				
Product No.	Frequency	Transmit Power	Channels	Data Rate
All HN-50 Series products are based on the WIT2450 and can be used as base stations. All features and modes of the WIT2450 are supported in the HN-50 products.				
HN-250	2.4 GHz	40mW/100mW/250mW	93	460.8 Kbps
HN-250U	2.4 GHz	40mW/100mW/250mW	93	460.8 Kbps
HN-550	2.4 GHz	40mW/100mW/250mW	93	460.8 Kbps

2.4GHz 460.8Kbps HN-10 Series Standalone Wireless Modems				
Product No.	Frequency	Transmit Power	Channels	Data Rate
All HN-10 and -14 Series products below are based on the WIT2410 and can be used as base stations. All features and modes of the WIT2410 are supported in the HN-series products. The HN-210D/X products also support Modbus operation. The HN-11 Series are based on the 1.23 Mbps WIT2411. HN 2 series products include an internal 6dB patch antenna. HN 2X series products provide a reverse TNC antenna connector.				
HN-210	2.4 GHz	100 mW	75	460.8 Kbps
HN-210D	2.4 GHz	100 mW	75	460.8 Kbps
HN-210X	2.4 GHz	100 mW	75	460.8 Kbps
HN-210DX	2.4 GHz	100 mW	75	460.8 Kbps
HN-211R	2.4 GHz	100 mW	43	1.23 Mbps
HN-211RX	2.4 GHz	100 mW	43	1.23 Mbps
HN-211U	2.4 GHz	100 mW	43	1.23 Mbps
HN-211UX	2.4 GHz	100 mW	43	1.23 Mbps
HN-214	2.4 GHz	100 mW	75	460.8 Kbps
HN-214D	2.4 GHz	100 mW	75	460.8 Kbps
HN-214X	2.4 GHz	100 mW	75	460.8 Kbps
HN-214DX	2.4 GHz	100 mW	75	460.8 Kbps
HN-510	2.4 GHz	100 mW	75	460.8 Kbps
HN-1010	2.4 GHz	100 mW	75	460.8 Kbps
HN-1510	2.4 GHz	100 mW	75	460.8 Kbps
HN-2010	2.4 GHz	100 mW	75	460.8 Kbps
HN-3010	2.4 GHz	100 mW	75	460.8 Kbps

Long-Range Wireless Industrial Telemetry

Proprietary FHSS Serial-to-Ethernet Access Points

SNAP Wireless Serial to Ethernet Access Points (900 MHz – 2.4 GHz)

As the base station for RFM WIT-series 900 MHz and 2.4 GHz OEM modules (WIT910, WIT2410, WIT2411, and WIT2450) and RFM HN-series modems, SNAP access points provide seamless serial-to-Ethernet connectivity, with remote wireless nodes transmitting unformatted data to a server-based application running on the SNAP Ethernet network. The SNAP removes the need for the remote devices to handle the TCP/IP protocol.

Certified by the FCC and CE marked on 2.4 GHz products, the SNAP family offers license-free use.

- **RFM FHSS technology** — Patented FHSS technology provides reliable communications in high noise floor environments, superior jamming and interference immunity. CRC checking and automatic repeat request (ARQ) deliver error-free data. Certified by the FCC and CE marked on 2.4 GHz products, the SNAP family offers license-free use.
- **Serial to Ethernet connectivity** — Allows transparent communication with remote devices and network-based applications. Allows limited intelligence and legacy serial devices to appear as nodes on an Ethernet network.
- **Customizable operation** — All parameters are configurable under software control. Even transmit power can be selected through a straightforward command set.
- **Suited to tough environments** — Both the SNAP2410 and SNAP2411 are available in "D" DIN rail mount versions and "X" versions which are NEMA IP rated aluminum enclosures for harsh and outdoor use.

SNAP Wireless Access Points for Ethernet Network				
Product No.	Frequency	Transmit Power	Channels	Data Rate
SNAP910X	900 MHz	1 Watt	54	172 Kbps
SNAP910D	900 MHz	1 Watt	54	172 Kbps
SNAP2410	2.4 GHz	100 mW	75	460 Kbps
SNAP2410X	2.4 GHz	100 mW	75	460 Kbps
SNAP2410D	2.4 GHz	100 mW	75	460 Kbps
SNAP2410DX	2.4 GHz	100 mW	75	460 Kbps
SNAP2411	2.4 GHz	100 mW	43	1.23 Mbps
SNAP2411X	2.4 GHz	100 mW	43	1.23 Mbps
SNAP2411D	2.4 GHz	100 mW	43	1.23 Mbps
SNAP2411DX	2.4 GHz	100 mW	43	1.23 Mbps

SNAP Cables, Antennas, and Accessories
RFM offers a full line of cable, antennas and accessories for use with the SNAP family of products. See the RFM CD catalog or go to www.RFM.com for detailed listings of accessories.

Long-Range Wireless Industrial Telemetry

Proprietary FHSS Wireless Ethernet Bridges

SEM Wireless Spread Spectrum Ethernet Bridges (900 MHz – 2.4 GHz)

RFM SEM-series wireless Ethernet bridges provide high-speed wireless connectivity between distant Ethernet nodes where cable runs are impractical. All SEMs feature the company's patented FHSS technology. Typical SEM uses include Ethernet bridging, SCADA networking, PLC networking, and other industrial automation or data collection applications. SEMs can function as a high speed bridge between two 10/100BaseT Ethernet networks; they can also provide wireless connectivity between an Ethernet base station and multiple Ethernet remote modems. Highly complex networks and extended coverage can be achieved by combining point-to-point or point-to-multipoint configurations with RFM repeaters.

The RFM SEM Ethernet Bridges are Class I, Div. 2 certified in both the 900 MHz and 2.4 GHz bands. SEM bridges include a standard 10/100 Base-T Ethernet port, antenna, and power connectors. Five LEDs indicate power status and data activity. Class I Div 1 versions are available by special order.

The SEM "D" model Ethernet radio is a DIN rail mount version, and the SEM "X" models use a remote, weatherproof, wireless Ethernet radio housed in a NEMA 4X / IP 66 enclosure.

900 MHz SEM Ethernet Bridges

RFM SEM wireless 900 MHz Ethernet bridge is a high speed/long range wireless networking product that provides 172.8 kbps over-the-air data rate and over 20 miles demonstrated communications range with 3 dB omni-directional antenna. Uses for a SEM wireless 900 MHz Ethernet bridge include SCADA networks, PLC networking, and other industrial automation or data collection applications.

2.4 GHz SEM Ethernet Bridges

The SEM2410 and SEM2411 link Ethernet nodes in an industrial communication hierarchy up to 5 miles apart (with gain antennas). The over-the-air data rate for the SEM2410 is 460 Kbps and 1.23 Mbps for the SEM2411. RFM patented FHSS assures reliable performance even in high-multipath and noisy RF environments.

Ethernet Radio Security

RFM SEM wireless Ethernet bridges provide multiple levels of security. First, their communications use RFM proprietary frequency hopping spread spectrum (FHSS) protocol, which is understood only by other SEM Ethernet radio devices configured to use the same hopping pattern (out of 64 possibilities). To ensure that the SEM master communicates only with its intended SEM slaves, the SEM master can be configured to define the precise number of slaves (up to 62) that can register on the network, and can also be configured to authenticate an ID and password from each SEM slave prior to granting registration. Finally, SEM Ethernet radios include password protection for both console port and Telnet sessions, and can be configured to allow the opening of Telnet sessions only from specified IP addresses.

SEM: Spread Spectrum Wireless Ethernet Bridge				
Product No.	Frequency	Transmit Power	Channels	Data Rate
SEM910	900 MHz	1 Watt	54	172.8 Kbps
SEM910D DIN-rail Mount	900 MHz	1 Watt	54	172.8 Kbps
SEM910X Remote Radio	900 MHz	1 Watt	54	172.8 Kbps
SEM910DX	900 MHz	1 Watt	54	172.8 Kbps
SEM2410	2.4 GHz	100 mW	75	460.8 Kbps
SEM2410D DIN-rail Mount	2.4 GHz	100 mW	75	460.8 Kbps
SEM2410DX	2.4 GHz	100 mW	75	460.8 Kbps
SEM2410X Remote Radio	2.4 GHz	100 mW	75	460.8 Kbps
SEM2411	2.4 GHz	100 mW	43	1.23 Mbps
SEM2411D DIN-rail Mount	2.4 GHz	100 mW	43	1.23 Mbps
SEM2411DX	2.4 GHz	101 mW	43	1.23 Mbps
SEM2411X Remote Radio	2.4 GHz	100 mW	43	1.23 Mbps
SEM2411LC Remote Bridge	2.4 GHz	100 mW	43	1.23 Mbps

Long-Range Wireless Industrial Telemetry

Proprietary FHSS I/O Modems

HNIO HN-series I/O Modems (900 MHz – 2.4 GHz)

RFM HNIO modems feature bidirectional transmission and the company's patented FHSS technology. The product line includes the HNIO-091R and HNIO-241R relay modems, which operate at 900 MHz and 2.4 GHz respectively, and two analog/digital modems, the 900 MHz HNIO-091A and 2.4 GHz HNIO-241A. The relay modems provide four 250VAC 5A relays, and the analog/digital modems provide two 4-20mA receivers and transmitters along with two digital I/O channels.

Unlike wireless data transceivers, which transmit serial data streams, wireless I/O modems transmit voltage or digital signals. Analog/digital models are typically used to relay key levels of sensor data, while relay units control the state of such equipment as light fixtures, alarms, and locks. Line of sight range extends beyond 20 miles for the 900 MHz I/O modems and up to seven miles for the 2.4 GHz units, depending upon the antenna used. The modems can operate over an input voltage range of +9Vdc to +30Vdc, making them suitable for battery and solar power sources. Class I Div 2 certification allows the modems to be deployed in hazardous locations. All are DIN-rail mountable.

I/O modems and relays for analog/relay input/output				
Product No.	Frequency	Transmit Power	Channels	Data Rate
HNIO-091A	900 MHz	1 Watt	54	172.8 Kbps
HNIO-091AR	900 MHz	1 Watt	55	172.8 Kbps
HNIO-091AX	900 MHz	1 Watt	56	172.8 Kbps
HNIO-091R	900 MHz	1 Watt	57	172.8 Kbps
HNIO-091RR	900 MHz	1 Watt	58	172.8 Kbps
HNIO-091RX	900 MHz	1 Watt	59	172.8 Kbps
HNIO-241A	2.4 GHz	100 mW	75	460.8 Kbps
HNIO-241AR	2.4 GHz	100 mW	76	460.8 Kbps
HNIO-241AX	2.4 GHz	100 mW	77	460.8 Kbps
HNIO-241R	2.4 GHz	100 mW	78	460.8 Kbps
HNIO-241RR	2.4 GHz	100 mW	79	460.8 Kbps
HNIO-241RX	2.4 GHz	100 mW	80	460.8 Kbps

HNIO Cables, Antennas, and Accessories
RFM offers a full line of cable, antennas and accessories for use with the HNIO family of products. See the RFM CD catalog or go to www.RFM.com for detailed listings of accessories.

Long-Range Wireless Industrial Telemetry

802.11b/g OEM Modules, Eval Kits, Industrial Bridges, Serial-to-Ethernet Bridges, and Ethernet-to-Ethernet Bridges

802.11b/g Wireless LAN Module (2.4 GHz)

RFM offers a selection of industrial 802.11b/g modules, to which it adds antenna technology, integration, and applications support. Our offering for OEM use is the Airborne 802.11b/g wireless LAN module, which includes a radio, a base-band processor, an application processor, and software for a drop-in Web-enabled WiFi solution.

Since there's no need to develop the software, or to develop the RF and communications expertise in-house, OEMs can realize reduced product development costs and a quick time-to-market. Airborne modules provide instant LAN and Internet connectivity, and connect through standard serial interfaces to a wide variety of applications.

- **Small footprint** — easily embedded into new or existing designs.
- **Interoperates with standard 802.11b/g access points** — Low-cost infrastructure for connections.
- **Built-in TCP/IP stack, RTOS and application software** — Provides embedded devices with instant LAN and Internet connectivity without special programming of the module.
- **Integrated Web server** — Easy to remotely monitor and control any device using a standard browser
- **Drop-in WiFi solution** – Reduces time to market and development costs.
- **Complete Developer Kit** – Everything a designer needs to evaluate the 802.11 wireless communications system.

802.11b/g Modules				
Product No.	Frequency	Transmit Power	Channels	Data Rate
WSN802G	2.4 GHz	10 mW	14	1 or 2 Mbps
WLNG-AN-DP101	2.4 GHz	100 mW	13	54 Mbps
WLNG-ET-DP101	2.4 GHz	100 mW	13	54 Mbps
WLNG-SE-DP101	2.4 GHz	100 mW	13	54 Mbps
WLNG-RA-DP101	2.4 GHz	100 mW	13	54 Mbps

802.11b/g Evaluation Kits	
Product No.	Description
WSN802GDK	WSN802G Module Evaluation Kit containing development/prototyping board with module, Serial and USB cables, power supplies and utility software
WLNG-EK-DP001	WLN Module Evaluation Kit containing development/prototyping board with module, 802.11b access point w/antenna, 2dB dipole antenna, power supplies and utility software
WLNG-EK-DP003	WLN Module Evaluation Kit without access point containing development/prototyping board with module, 2dB dipole antenna, power supplies and utility software

Industrial 802.11b/g Bridges				
Product No.	Frequency	Transmit Power	Channels	Data Rate
HN-208E	2.4 GHz	100 mW	13	54 Mbps

Serial to 802.11b/g Ethernet Bridges				
Product No.	Frequency	Transmit Power	Channels	Data Rate
ABDG-SE-DP101	2.4 GHz	100 mW	13	54 Mbps
ABDG-SE-DP103	2.4 GHz	100 mW	13	54 Mbps
ABDG-SE-DP104	2.4 GHz	100 mW	13	54 Mbps
ABDG-SE-DP106	2.4 GHz	100 mW	13	54 Mbps
ABDG-SE-DP107	2.4 GHz	100 mW	13	54 Mbps
ABDG-SE-DP109	2.4 GHz	100 mW	13	54 Mbps

802.11b/g Ethernet to Ethernet Bridges				
Product No.	Frequency	Transmit Power	Channels	Data Rate
ABDG-ET-DP101	2.4 GHz	100 mW	13	54 Mbps
ABDG-ET-DP102	2.4 GHz	100 mW	13	54 Mbps
ABDG-ET-DP103	2.4 GHz	100 mW	13	54 Mbps

802.11b/g Evaluation Kits				
Product No.	Frequency	Transmit Power	Channels	Data Rate
ABEG-SE-DP101	2.4 GHz	100 mW	13	54 Mbps
ABEG-SE-DP102	2.4 GHz	100 mW	13	54 Mbps
ABEG-ET-DP101	2.4 GHz	100 mW	13	54 Mbps
ABEG-ET-DP102	2.4 GHz	100 mW	13	54 Mbps

Long-Range Wireless Industrial Telemetry

Bluetooth OEM RF Modules, Dev Kits, and Access Servers available only in U.S.

BlueGiga Bluetooth Modules (2.4 GHz)

In the U.S. RFM resells Bluetooth modules made by Bluegiga Technologies. For OEM use, we offer three Bluegiga WRAP THOR™ modules.

OEM Data Modules

The WT11-series is a revolutionary Class 1, *Bluetooth* 2.0+EDR (Enhanced Data Rate 3Mbps) module operating at 40mW transmit power. The WT12 is a next-generation Class 2, *Bluetooth* 2.0+EDR module operating at 1.5mW transmit power. Both the WT11- and the WT12-series introduce three times faster data rates compared to existing *Bluetooth* 1.2 modules with even lower power consumption.

The WT11- and WT12-series are highly integrated Bluetooth modules, containing all the necessary elements from Bluetooth® radio to antenna with a fully implemented protocol stack, and full certifications. The WT12-series is ideal for applications that do not need the range of a Class 1 module but rather need to conserve as much power as possible.

The WT11- and WT12-series are designed for products that need medium range and high capacity wireless connections including Point-of-Sale systems, bar code and RFID scanners, medical measurement and data transfer systems, automotive inspection and measurement systems, telemetry and machine-to-machine interfaces, special purpose PDAs and PCs, and industrial PCs and Laptops.

OEM Audio Modules

The W32-series Audio Modules combine Bluetooth radio technology with embedded DSP, stereo codec and battery charger functions for seamless integration into mono and stereo audio applications. DSP echo cancellation, noise reduction and advanced audio decoding provide excellent audio clarity in difficult environments. The W32-series modules are designed to operate over -40 to + 85 C, providing reliable operation in demanding industrial and mobile applications. W32-series modules are Bluetooth 2.1+EDR compliant and provide Class 2 Bluetooth range performance on a very low power budget for extended battery life.

Access Servers

Bluegiga Access Servers are cutting edge wireless Bluetooth routers, supporting the latest Bluetooth 2.0 Enhanced Data Rate standards and several other communication standards including Ethernet, Wi-Fi, and GSM/GPRS enabling full media-independent TCP/IP connectivity. Bluegiga Access Servers are easy to deploy and manage in existing wired and wireless networks without compromising reliability, speed or security. The device can be conveniently managed and remotely upgraded over encrypted links using Bluegiga Solution Manager Software.

Bluegiga Access Servers are widely used from mission-critical applications to high-volume marketing applications, and are ideal for content and application distribution to mobile phones and PDAs, point-of-sales systems, logistics and transportation systems, Bluetooth-to-TCP/IP networking, telemetry and machine-to-machine systems, medical and health care systems, fitness and sport telemetry systems, cable replacement, and as network access points. Bluegiga Access Server are targeted at system integrators and original equipment manufacturers wanting to deploy a secure, cost effective, low power wireless network for Bluetooth-equipped devices.

Bluetooth Surface Mount Modules				
Product No.	Frequency	Transmit Power	Channels	Data Rate
WT11-A-AI	2.4 GHz	40 mW	79	1/2/3 Mbps
WT11-A-HCI	2.4 GHz	40 mW	79	1/2/3 Mbps
WT11-E-AI	2.4 GHz	40 mW	79	1/2/3 Mbps
WT11-E-HCI	2.4 GHz	40 mW	79	1/2/3 Mbps
WT12-A-AI	2.4 GHz	1.5 mW	79	1/2/3 Mbps
WT12-A-HCI	2.4 GHz	1.5 mW	79	1/2/3 Mbps
WT32-A-AI	2.4 GHz	1.5 mW	79	1/2/3 Mbps
WT32-E-AI	2.4 GHz	1.5 mW	79	1/2/3 Mbps

Bluetooth Evaluation Kits	
Product No.	Description
EKWT12-A	WT12 Evaluation Kit with 2 eval boards and Onboard Installation Kit
EKWT11-A	WT11 Evaluation Kit with 2 eval boards and Onboard Installation Kit
EKWT11-E	WT11 Evaluation Kit with 2 eval boards antenna cables, antennas, and Onboard Installation Kit
EBWT32-A	WT32 Evaluation Board including stereo headset, onboard installation kit, USB / Serial cable
THOR inst kit	WRAP THOR On-Board Installation kit **

Bluetooth Access Servers	
Product No.	Description
2291	7 connections, 1 BT Radio, 56 Bit BT Encryption
2293	21 connections 3 BT Radios, 56 Bit BT Encryption
2291-128	7 connections, 1 BT Radio, 128 Bit BT Encryption
2293-128	21 connections 3 BT Radios, 128 Bit BT Encryption
2291-56-EXT	7 connections, 1 BT Radio, 56 Bit BT Encryption, SMA ant.
2291-128-EX	7 connections, 1 BT Radio, 128 Bit BT Encryption
2293-56-EXT	21 connections, 3 BT Radios, 56 Bit BT Encryption, SMA ant.
2293-128-EXT	21 connections, 3 BT Radios, 128 Bit BT Encryption, SMA ant.
229X-M	21 connections 3 BT Radios, 128 Bit BT Encryption, SMA ant.
2290-WLAN	Mounting Accessory for wall and ceiling
2290-GPRS	WLAN CF Card for 229x Access Server
W9SDK	GPRS CF Card for 229x Access Server
W9SWCD	WRAP Access Server SDK including WRAP2293 Access Server

©2009 RF Monolithics, Inc. All rights reserved.

TRADEMARKS: RF Monolithics, Aleier, ASH, Virtual Wire, MiniMESH and VersaMESH are all registered trademarks of RFM. The stylized logos RFM, and Aleier are also registered trademarks of RFM. All other trademarks (such as ZigBee, BlueTooth, Airborne Technologies, BlueGiga, etc.) are the property of their respective owners. The specifications and availability of the components described in this publication are subject to change without notice. Every effort has been made to ensure the accuracy of this publication. However, RF Monolithics, Inc. does not assume responsibility for inaccuracies or changes. "Typical" specifications are based on measurements made on representative samples. These values may vary from lot to lot and are not guaranteed. They are provided only as a reference for the circuit designer. Many products utilizing the components described in this publication require approval by the government of the destination country prior to sale. Buyers of these components assume all responsibility for compliance, testing and authorization by the appropriate government agencies. RF Monolithics, Inc. makes no warranty, representation, or guarantee regarding the suitability of these products for any particular purpose. None of these devices are intended for surgical implants or any other application that may provide life support or other critical function necessary for the support or protection of life, property, or business interests. The user assumes responsibility for use of any of these products in any such application. RF Monolithics, Inc. shall not be liable for losses due to failure of any of these devices beyond the RFM commercial warranty, limited to the original purchase price. Many of the devices described in this publication are patented. RF Monolithics, Inc. does not convey any license under its patent rights or the rights of others.

Revised July 2009



How to Buy

RFM has a global network of distributors, sales representatives and stocking representatives.

- Contact a regional sales representative or distributor for product pricing and availability.
- Go to www.rfm.com/reps/howtobuy.shtml to purchase online.