



STEVAL-TDR011V1

2-stage RF power amplifier with LPF based on the PD85006L-E and STAP85050 RF power transistors

Features

- Excellent thermal stability
- Frequency: 400 - 470 MHz
- Supply voltage: 13.6 V
- Output power: 50 W
- Current: < 10 A
- Input power: 20 dBm
- Harmonics level < -45 dBc
- Output low-pass filter
- Power detection
- Temperature sensor

Description

The STEVAL-TDR011V1 demonstration board is a two-stage 50 W RF power amplifier which includes an output LPF (low-pass filter) for harmonics rejection. It also features power detection and a temperature sensor.

The main purpose of the board is to demonstrate the functioning and performance of the PD85006L-E and the STAP85050 devices from the LdmoST plastic family of RF power transistors.

The application is specifically designed for 2-way analog and digital mobile radios.

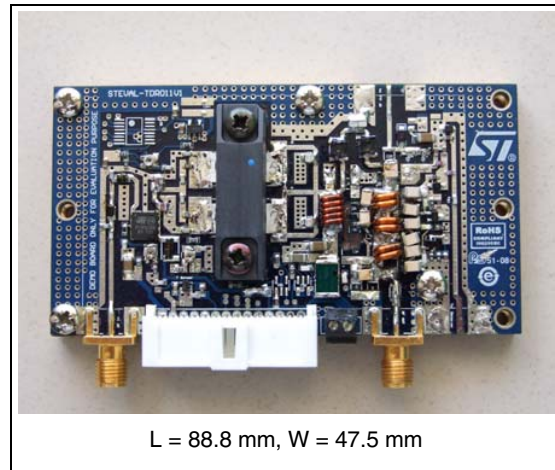

Table 1. Device summary

Order code
STEVAL-TDR011V1

Contents

1	Electrical data	3
	1.1 Maximum ratings	3
	1.2 Electrical characteristics	3
2	Typical performance	4
3	Circuit layout	9
4	Schematic diagram	10
5	Revision history	11

1 Electrical data

1.1 Maximum ratings

Table 2. Absolute maximum ratings

Symbol	Parameter	Value	Unit
V_{DD}	Supply voltage ⁽¹⁾	16	V
I_D	Drain current	12	A
T_{CASE}	Operating case temperature	-10 to +85	°C
T_A	Max. ambient temperature	+55	°C

1. Value related to the voltage regulator LD2980ABM50TR used in the application.

1.2 Electrical characteristics

$T_A = +25\text{ °C}$, $V_{DD} = 13.6\text{ V}$, V_{APC} adjusted

Table 3. Electrical specifications

Symbol	Test conditions	Min.	Typ.	Max.	Unit
Freq.	Frequency range	400		470	MHz
P_{IN}	@ $P_{OUT} = 50\text{ W}$		20		dBm
I_{TOTAL}	@ $P_{OUT} = 50\text{ W}$			10	A
Gain	@ $P_{OUT} = 50\text{ W}$		27		dB
Harmonics	@ $P_{OUT} = 50\text{ W}$		-50 / -74		dBc

2 Typical performance

Figure 1. Output power and drain current vs. frequency **Figure 2. Gain vs. frequency**

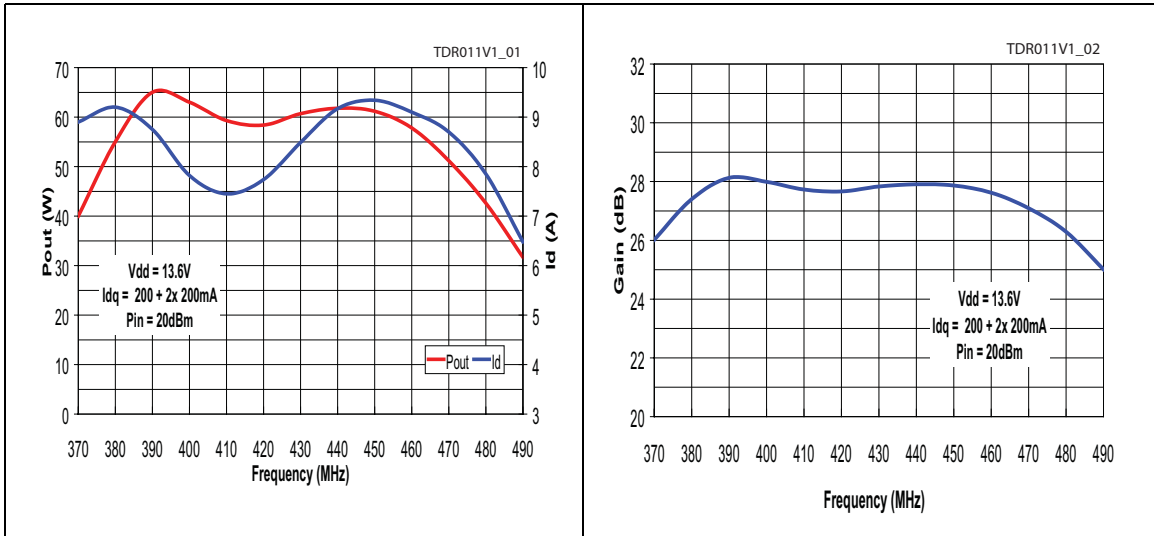

Figure 3. Efficiency vs. frequency **Figure 4. Input return loss vs. frequency**

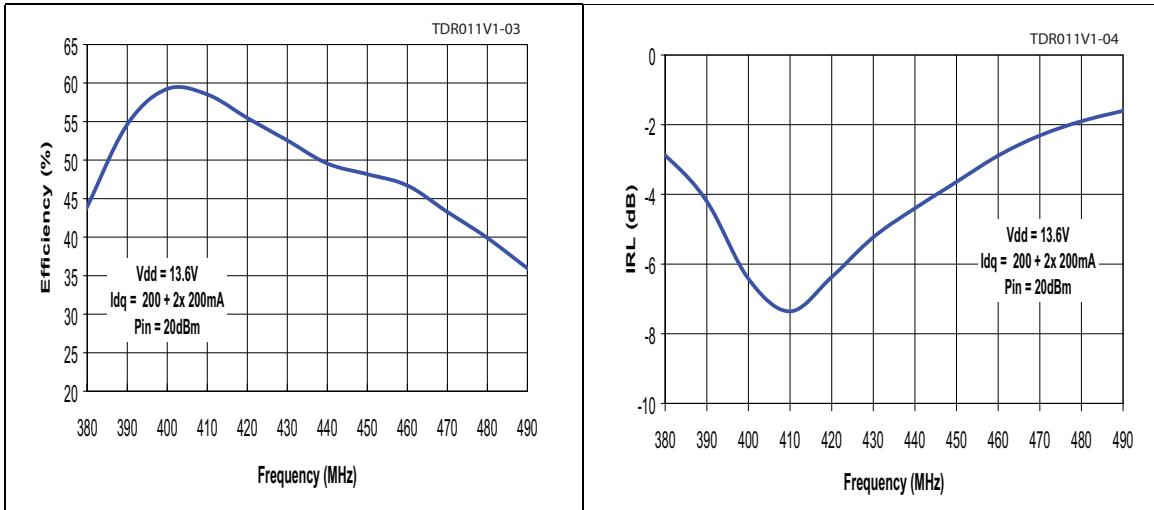

Figure 5. Gain vs. output power

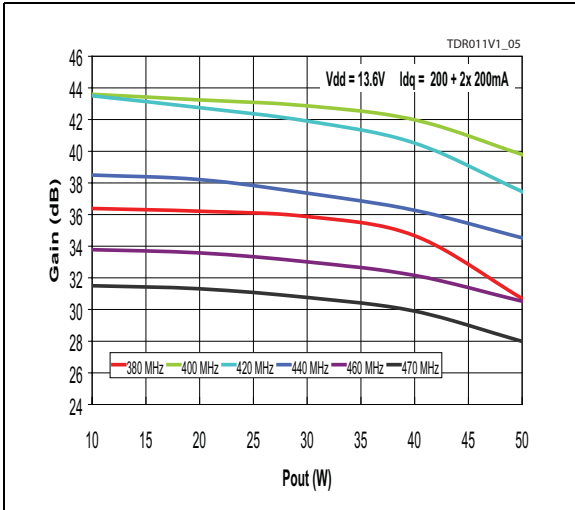

Figure 6. Harmonics

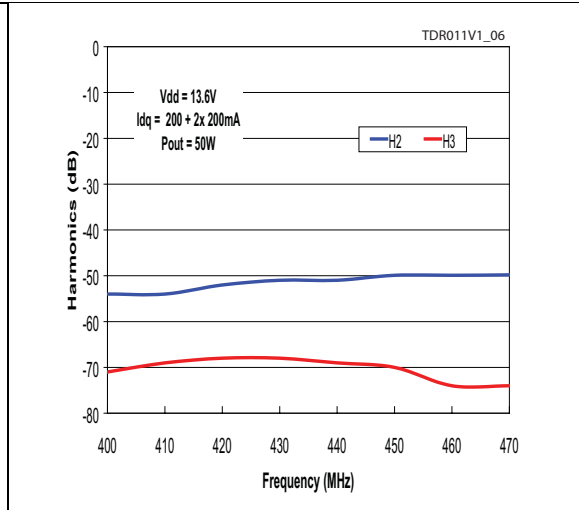

Figure 7. Vp1-Vp2 vs. output power

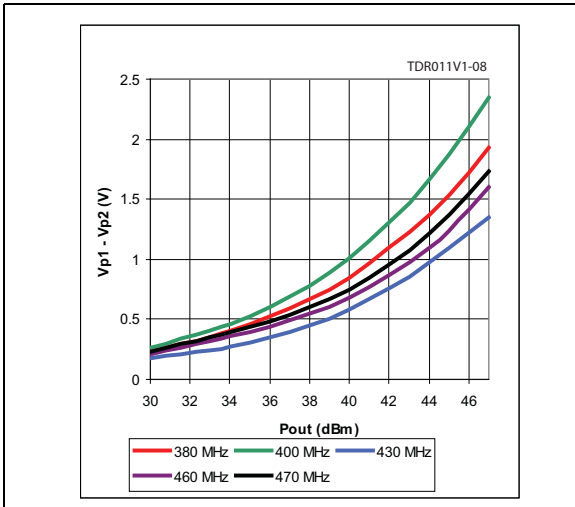

Figure 8. Vp1-Vp2 vs. output power

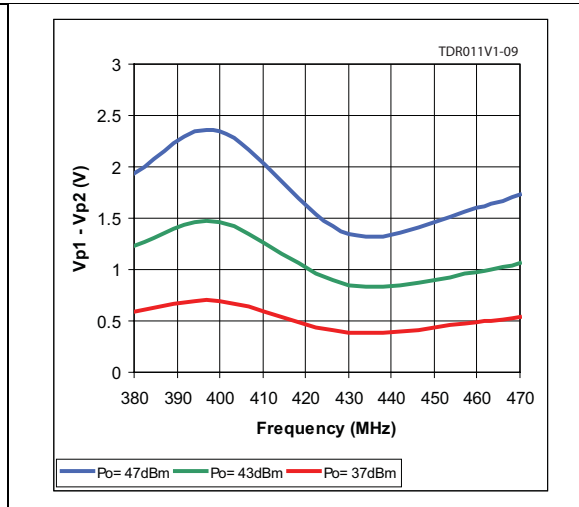

Figure 9. Drain current and temperature record on PCB surface

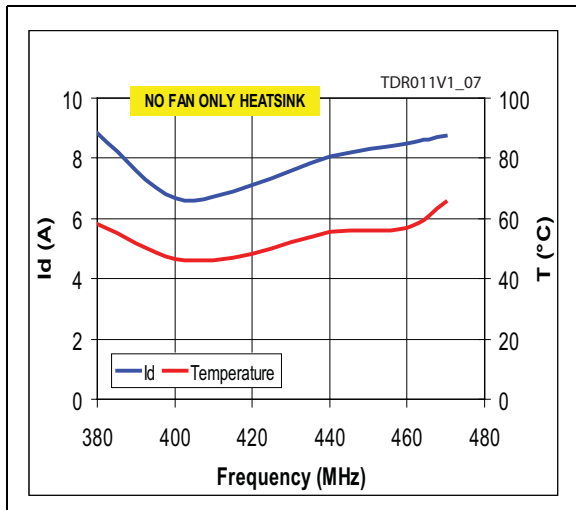

Table 4. Component list

Designator	Value	Qty	Manufacturer	Order code	Size/package
C1	10 μ F	1	Murata	GRM31CR61E106KA12	1206
C1f, C2f, C3f	3.9 pF	3	ATC	ATC 100B 3R9JW	1111
C1p, C2p	5 pF	2	Murata	GRM1885C1H5R0CZ01	0603
C1t	10 pF	1	Murata	GRM1885C1H100JA01	0603
C2	100 pF	1	Murata	GRM42-6 COG 101J 50	1206
C2a, C3a, C5a, C6a	1 pF	4	Murata	GRM1885C1H1R0CZ01	0603
C2t	0.1 μ F	1	Murata	GRM1885C1H101JA01	0603
C3	0.1 μ F	1	Murata	GRM188F5H1104ZA01	0603
C3p, C5p	1 pF	2	ATC	ATC 100B 1R0JW	1111
C4, C9	0.1 μ F	2	Murata	GRM188F5H1H04ZA01	0603
C4p, C6p	9.1 pF	2	ATC	ATC 100B 9R1JW	1111
C5, C8, C8a, C10, C11, C12	100 pF	6	Murata	GRM1885C1H101JA01	0603
C5f, C6f	5.6 pF	2	ATC	ATC 100B 5R6JW	1111
C6, C7	47 pF	2	Murata	GRM1885C1H470JA01	0603
C9a	4.7 μ F	1	Murata	GRM31CF51H475ZA01	1206
C13	18 pF	1	Murata	GRM1885C1H180JA01	0603
C14	15 pF	1	Murata	GRM1885C1H150JA01	0603
C14a, C14b	18 pF	2	Murata	GRM1885C1H180JZ01B	0603
C15	5.6 pF	1	Murata	GRM1885C1H5R6DZ01	0603
C16	39 pF	1	Murata	GRM1885C1H390JA01	0603

Table 4. Component list (continued)

Designator	Value	Qty	Manufacturer	Order code	Size/package
C17, C18	150 pF	2	Murata	GRM1885C1H151JA01	0603
C19, C20	39 pF	2	Murata	ERF1DM5C1H390JD01B	0505
C21	33 pF	1	Murata	MA59C0G330J150	0505
C22a	12 pF	1	Murata	ERF1DM5C1H120JD01B	0505
C22b	4.7 pF	1	Murata	MA59C0G4R7C150	0505
Caf	100 pF	1	ATC	ATC 100B 101JW	1111
Ci	2.2 μ F	1	Murata	GRM188R71A225KE15	0603
Co	1 μ F	1	Murata	GRM188R71C105KA12D	0603
CS1		1	Integration Associates, Inc	IA2410	SOT-23 5-pin
CS2		1	Integration Associates, Inc	IA4210	SOT-23 5-pin
D1a, D2a		2	MACOM	MA4P7101F-1072T	
D1p, D2p		2	STMicroelectronics	BAS70-04WFILM	SOT-323
D3a		1	STMicroelectronics	MA4P7436-1141T	SOD-323
D4a		1	MACOM	MA4P275-1141T	SOD-323
DB		1	MACOM	IA4910	TSSOP 16-pin
J1		1	Integration Associates, Inc	55935-1410	14-pin, single row
Jb		1	Molex	L04220211000	2-pin, 3.5 mm pitch
JP	2 pins - step 2.54mm -90°	1	LMI	5-826947-0	
L1	33 nH	1	Tyco Electronics	AS080447-33N	
L1a	470 nH	1	Korin Electronics	0805LS-471X_BC	0805LS
L1f, L2f, L3f	9.3 nH	3	Coilcraft	AS120252-9R3N	
L2	12.55 nH	1	Korin Electronics	1606-10	1606
L2a, L3a	6.8 nH	2	Coilcraft	0603HC-6N8X_BW	0603HC
L3	5.4 nH	1	Coilcraft	0906-5	0906
L4	5.4 nH	1	Coilcraft	0906-4	0906
L5, L6	5 nH	2	Korin Electronics	A02T	
PD1, PD2		2	STMicroelectronics	STAP85050 (or 2x PD85035S-E)	PSO-10
PD85006L-E		1	STMicroelectronics	PD85006L-E	PFLAT
TL1		1			W=0.9 mm, L=2 mm
TL2		1			W=0.9 mm, L=5 mm

Table 4. Component list (continued)

Designator	Value	Qty	Manufacturer	Order code	Size/package
TL3, TL15		2			W=0.9 mm, L=8 mm
TL4, TL6, TL16		3			W=0.9 mm, L=4 mm
TL5		1			W=0.9 mm, L=1.2 mm
TL9		1			W=0.9 mm, L=5.7 mm
TL10, TL11, TL18		3			W=0.9 mm, L=6 mm
TL12, TL13		2			W=0.9 mm, L=6.5 mm
TL14, TL17		2			W=0.9 mm, L=2.5 mm
R1, R8, R9	220 Ω	3	Tyco Electronics		0603
R1a, R2, R7, R10	1 k Ω	4	Murata	PVZ2A102C04B00	
R1p, R2p, R3p, R4p	20 k Ω	4	Tyco Electronics		0603
R1t	100 k Ω	1	Tyco Electronics		0603
R3, R6, R11	2.2 k Ω	3	Tyco Electronics		0603
R4, R5	15 k Ω	2	Tyco Electronics		0603
R5p, R6p, R7p, RG3, RG4	50 Ω	5	Tyco Electronics		0603
R12	330 Ω	1	Tyco Electronics		0603
R13, R14	1 Ω	2	Tyco Electronics		0603
RF ant, RF in, RF out PA, to receiver			Johnson	142-0701-801	60 Mils
RG1, RG2	200 Ω	2	Tyco Electronics		0603
RO1	5 k Ω	2	Tyco Electronics		0603
RO2	2 k Ω	2	Tyco Electronics		0603
Thermal Sensor		1	STMicroelectronics	STLM20	SOT323-5
Voltage regulator		1	STMicroelectronics	LD2980ABM50TR	SOT-23-5

3 Circuit layout

Figure 10. Test fixture component layout

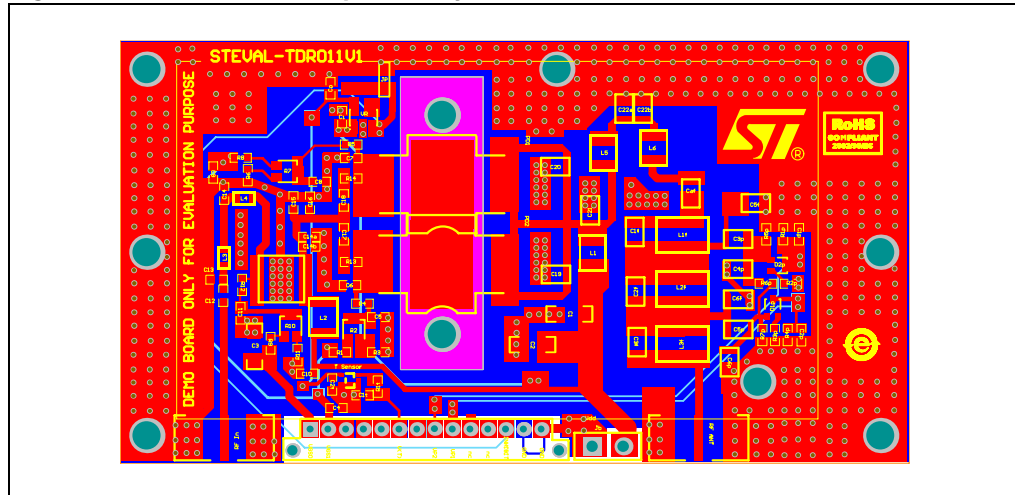

4 Schematic diagram

Figure 11. STEVAL-TDR011V1 schematic diagram

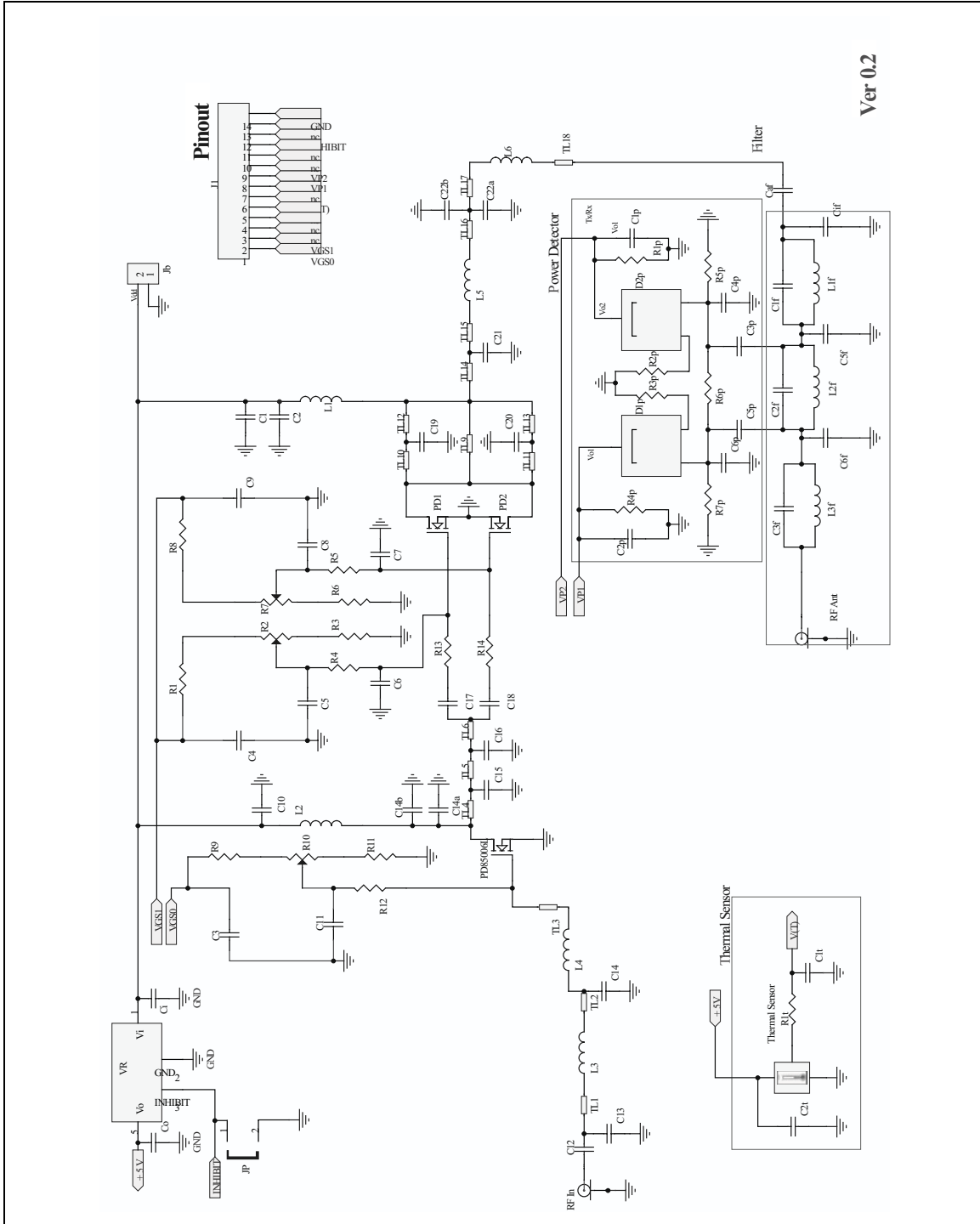

5 Revision history

Table 5. Document revision history

Date	Revision	Changes
31-Mar-2010	1	Initial release.

Please Read Carefully:

Information in this document is provided solely in connection with ST products. STMicroelectronics NV and its subsidiaries ("ST") reserve the right to make changes, corrections, modifications or improvements, to this document, and the products and services described herein at any time, without notice.

All ST products are sold pursuant to ST's terms and conditions of sale.

Purchasers are solely responsible for the choice, selection and use of the ST products and services described herein, and ST assumes no liability whatsoever relating to the choice, selection or use of the ST products and services described herein.

No license, express or implied, by estoppel or otherwise, to any intellectual property rights is granted under this document. If any part of this document refers to any third party products or services it shall not be deemed a license grant by ST for the use of such third party products or services, or any intellectual property contained therein or considered as a warranty covering the use in any manner whatsoever of such third party products or services or any intellectual property contained therein.

UNLESS OTHERWISE SET FORTH IN ST'S TERMS AND CONDITIONS OF SALE ST DISCLAIMS ANY EXPRESS OR IMPLIED WARRANTY WITH RESPECT TO THE USE AND/OR SALE OF ST PRODUCTS INCLUDING WITHOUT LIMITATION IMPLIED WARRANTIES OF MERCHANTABILITY, FITNESS FOR A PARTICULAR PURPOSE (AND THEIR EQUIVALENTS UNDER THE LAWS OF ANY JURISDICTION), OR INFRINGEMENT OF ANY PATENT, COPYRIGHT OR OTHER INTELLECTUAL PROPERTY RIGHT.

UNLESS EXPRESSLY APPROVED IN WRITING BY AN AUTHORIZED ST REPRESENTATIVE, ST PRODUCTS ARE NOT RECOMMENDED, AUTHORIZED OR WARRANTED FOR USE IN MILITARY, AIR CRAFT, SPACE, LIFE SAVING, OR LIFE SUSTAINING APPLICATIONS, NOR IN PRODUCTS OR SYSTEMS WHERE FAILURE OR MALFUNCTION MAY RESULT IN PERSONAL INJURY, DEATH, OR SEVERE PROPERTY OR ENVIRONMENTAL DAMAGE. ST PRODUCTS WHICH ARE NOT SPECIFIED AS "AUTOMOTIVE GRADE" MAY ONLY BE USED IN AUTOMOTIVE APPLICATIONS AT USER'S OWN RISK.

Resale of ST products with provisions different from the statements and/or technical features set forth in this document shall immediately void any warranty granted by ST for the ST product or service described herein and shall not create or extend in any manner whatsoever, any liability of ST.

ST and the ST logo are trademarks or registered trademarks of ST in various countries.

Information in this document supersedes and replaces all information previously supplied.

The ST logo is a registered trademark of STMicroelectronics. All other names are the property of their respective owners.

© 2010 STMicroelectronics - All rights reserved

STMicroelectronics group of companies

Australia - Belgium - Brazil - Canada - China - Czech Republic - Finland - France - Germany - Hong Kong - India - Israel - Italy - Japan - Malaysia - Malta - Morocco - Philippines - Singapore - Spain - Sweden - Switzerland - United Kingdom - United States of America

www.st.com