



ConnectPort™ X Family User's Guide

ConnectPort™ X Family Products:

ConnectPort X2

ConnectPort X2 XTend™/XStream® variants

ConnectPort X4

ConnectPort X4 H

ConnectPort X8

©Digi International Inc. 2010. All Rights Reserved.

The Digi logo, Digi Connect, iDigi, ConnectPort, Digi SureLink, Digi Dialserv are trademarks or registered trademarks of Digi International, Inc.

All other trademarks mentioned in this document are the property of their respective owners.

Information in this document is subject to change without notice and does not represent a commitment on the part of Digi International.

Digi provides this document “as is,” without warranty of any kind, either expressed or implied, including, but not limited to, the implied warranties of fitness or merchantability for a particular purpose. Digi may make improvements and/or changes in this manual or in the product(s) and/or the program(s) described in this manual at any time.

This product could include technical inaccuracies or typographical errors. Changes are periodically made to the information herein; these changes may be incorporated in new editions of the publication.

Contents

| | |
|--|-----------|
| Contents | 3 |
| About this guide | 6 |
| Purpose | 6 |
| Audience..... | 6 |
| Scope | 6 |
| Where to find more information..... | 6 |
| Digi contact information | 7 |
| Chapter 1: Introduction | 8 |
| Important Safety Information | 8 |
| ConnectPort X Family products | 9 |
| Wireless carrier certifications..... | 9 |
| Features | 10 |
| User interfaces..... | 10 |
| Quick reference for configuring features | 11 |
| Hardware features | 17 |
| Network interface features | 17 |
| Configurable network services..... | 17 |
| IP protocol support | 18 |
| Mobile/Cellular features and protocol support..... | 22 |
| RealPort software | 23 |
| Alarms | 23 |
| Modem emulation | 24 |
| Security features | 24 |
| Configuration management | 25 |
| Customization capabilities | 25 |
| Supported connections and data paths in Digi devices | 26 |
| Interfaces for configuring, monitoring, and administering Digi devices | 29 |
| Configuration capabilities | 29 |
| Configuration interfaces | 29 |
| Monitoring capabilities and interfaces | 36 |
| Device administration | 37 |
| Chapter 2: Hardware installation | 38 |
| Hardware installation for ConnectPort X4 H..... | 39 |
| Connector pinouts | 39 |
| Cable fittings | 42 |
| Antenna options and connectors | 43 |

| | |
|--|------------|
| SIM card slots..... | 44 |
| Power cable fitting | 45 |
| Optional Ethernet hub feature | 46 |
| Chapter 3: Configure Digi devices..... | 47 |
| Default IP address and methods for assigning an IP address | 48 |
| Configure an IP address using DHCP | 48 |
| Configure an IP address using Auto-IP | 48 |
| Configure an IP address from the command-line interface..... | 49 |
| IP addresses and the iDigi Platform | 49 |
| Test the IP address configuration | 49 |
| Configuration through the iDigi Platform | 50 |
| Create an Account on iDigi.com | 50 |
| Add the Digi device to the idigi.com Device List..... | 51 |
| iDigi Platform views for configuring and managing Digi devices | 53 |
| Configuration through the web interface..... | 58 |
| Open the web interface..... | 58 |
| Organization of the web interface | 60 |
| Change the IP address from the web interface, as needed | 63 |
| Network configuration settings | 64 |
| Mobile (cellular) settings | 108 |
| XBee network settings | 131 |
| Serial port settings..... | 141 |
| Camera settings | 150 |
| Alarms | 151 |
| System settings..... | 155 |
| Remote management settings..... | 161 |
| Security settings | 166 |
| Position (GPS support)..... | 169 |
| Applications | 171 |
| Configuration through the command line | 178 |
| Access the command line..... | 178 |
| Verify device support of commands | 178 |
| Configuration through Simple Network Management Protocol (SNMP)..... | 181 |
| Batch capabilities for configuring multiple devices..... | 181 |
| Chapter 4: Monitor and manage Digi devices | 182 |
| Monitoring capabilities from the iDigi Platform..... | 183 |
| Monitor/manage XBee networks | 183 |
| Monitoring capabilities in the web interface..... | 184 |
| Display system information | 184 |
| Manage connections and services | 202 |

| | |
|---|------------|
| Monitoring capabilities from the command line | 205 |
| Commands for displaying device information and statistics | 205 |
| Commands for managing connections and sessions | 207 |
| Commands for managing XBee networks and nodes | 208 |
| Monitoring Capabilities from SNMP | 209 |
| Chapter 5: Digi device administration | 210 |
| Administration from the web interface | 210 |
| File management | 211 |
| X.509 Certificate/Key Management | 212 |
| Backup/restore device configurations | 215 |
| Update firmware and Boot/POST Code | 216 |
| Restore a device configuration to factory defaults | 217 |
| Display system information | 220 |
| Reboot the Digi device | 220 |
| Enable/disable access to network services | 220 |
| Administration from the command-line interface | 221 |
| Chapter 6: Specifications and certifications | 222 |
| Hardware specifications | 223 |
| ConnectPort X2 specifications | 223 |
| ConnectPort X4 specifications | 225 |
| ConnectPort X4 H specifications | 226 |
| ConnectPort X8 specifications | 227 |
| Wireless networking features | 228 |
| Regulatory information and certifications | 230 |
| FCC certifications and regulatory information (USA only) | 230 |
| Industry Canada (IC) certifications | 231 |
| Safety statements | 232 |
| International EMC (Electromagnetic Emissions/Immunity/Safety) standards | 234 |
| Chapter 7: Troubleshooting | 235 |
| Troubleshooting Resources | 235 |
| System status LEDs | 236 |
| ConnectPort X2 LEDs and buttons | 236 |
| ConnectPort X4 LEDs and buttons | 238 |
| ConnectPort X4 H LEDs | 239 |
| ConnectPort X8 LEDs and buttons | 242 |
| Glossary | 245 |

About this guide

Purpose

This guide describes and shows how to install, provision, configure, monitor, and administer Digi devices.

Audience

This guide is intended for those responsible for setting up Digi devices. It assumes some familiarity with networking concepts and protocols. A glossary is provided with definitions for networking terms and features discussed in the content.

Scope

This guide focuses on configuration, monitoring, and administration of Digi devices. It does not cover hardware details beyond a certain level, application development, or customization of Digi devices.

Where to find more information

In addition to this guide, find additional product and feature information in the these documents:

- Online help and tutorials in the web interface for the Digi device
- Quick Start Guides
- RealPort[®] Installation Guide
- Cellular 101 Tutorial
- Digi Connect Family Customization and Integration Guide
- iDigi tutorials and user's guides
- Release Notes
- Cabling Guides
- Product information available on the Digi website, **www.digi.com**, and Digi's support site at **www.digi.com/support**, including, Support Forums, Knowledge Base, Data sheets/product briefs, application/solution guides, and carrier-specific documents
- Python developer Wiki

Digi contact information

For more information about Digi products, or for customer service and technical support, contact Digi International.

| To Contact Digi International by: | Use: |
|--|---|
| Mail | Digi International 11001 Bren Road East Minnetonka, MN 55343 U.S.A. |
| World Wide Web: | http://www.digi.com/support/ |
| email | http://www.digi.com/contactus/email.jsp/ |
| Telephone (U.S.) | (952) 912-3444 or (877) 912-3444 |
| Telephone (other locations) | +1 (952) 912-3444 or (877) 912-3444 |

Introduction

C H A P T E R 1

This chapter introduces Digi devices and their product families, types of connections and data paths in which Digi devices can be used, and the interface options available for configuring, monitoring, and administering Digi devices.

Important Safety Information



To avoid contact with electrical current:

- Never install electrical wiring during an electrical storm.
- Never install an Ethernet connection in wet locations unless that connector is specifically designed for wet locations.
- Use caution when installing or modifying lines.
- Use a screwdriver and other tools with insulated handles.
- Wear safety glasses or goggles.
- Do not place Ethernet wiring or connections in any conduit, outlet or junction box containing electrical wiring.
- Installation of inside wire may bring you close to electrical wire, conduit, terminals and other electrical facilities. Extreme caution must be used to avoid electrical shock from such facilities. Avoid contact with all such facilities.
- Ethernet wiring must be at least 6 feet from bare power wiring or lightning rods and associated wires, and at least 6 inches from other wire (antenna wires, doorbell wires, wires from transformers to neon signs), steam or hot water pipes, and heating ducts.
- Do not place an Ethernet connection where it would allow a person to use an Ethernet device while in a bathtub, shower, swimming pool, or similar hazardous location.
- Protectors and grounding wire placed by the service provider must not be connected to, removed, or modified by the customer.
- Do not touch uninsulated Ethernet wiring if lightning is likely!
- External Wiring: Any *external* communications wiring installed needs to be constructed to all relevant electrical codes. In the United States this is the National Electrical Code Article 800. Contact a licensed electrician for details.
- For ConnectPort X4 H only: the plug serves as a disconnect device, and must be easily accessible after the device is installed.

ConnectPort X Family products

The ConnectPort X Family of products is intended to provide gateway functionality between various network technologies such as Ethernet, cellular, Wi-Fi, and XBee. In addition to providing IP network connectivity between cellular, Wi-Fi and Ethernet networks and devices; ConnectPort X Family products are designed to provide remote connectivity to XBee networks as well as other devices connected to local ports: USB, 1-Wire, RabbitNet, and asynchronous serial. ConnectPort X Family products act as a coordinator for a mesh network. As with the Connect and Cellular product families, ConnectPort X Family products are supported by the iDigi platform, which can be used to remotely manage gateway devices and mesh networks.

Key features of ConnectPort X Family include:

- Network flexibility: gateway functionality for a variety of networks
- XBee-PRO Radio
- Currently Freescale-based, primarily 802.15.4
- Ember-250/XBee-based
- Commercial/Industrial Grade
- iDigi Platform: High-level and detailed views of XBee networks and nodes
- Personal Area Network (PAN) connectivity and management
- Support of Python programming language, for creating a variety of embedded programs and applications
- Remote help desk support through a WatchPort[®] Camera connection to a USB host port
- Security
- For some models, an internal GPS

Wireless carrier certifications

Digi devices are being certified around the world with major carriers supporting these technologies. For a current list of carrier certifications for your Digi product, go to digi.com and go to the product pages for your product. Click the Specs tab of the product pages. Carrier certifications are listed under **Mobile Certifications** or **Carrier Certifications**.

Features

This is an overview of key features in Digi devices. Software features are covered in more detail in the next three chapters. Hardware specifications and are covered in Chapter 6, "Specifications and certifications"

User interfaces

There are several user interfaces for configuring and monitoring Digi devices, including the following.

- The iDigi Platform
- A web-based interface for configuring, monitoring, and administering Digi devices. For Digi devices that ship with a default IP address, simply connecting a laptop computer to the Ethernet port of these products allows direct access to the web interface for configuration.
- A command-line interface available via local serial port, telnet or SSH.
- Simple Network Management Protocol (SNMP).

Quick reference for configuring features

This guide primarily focuses on configuring, monitoring, and administering Digi devices from the web interface. This table provides a quick reference for configuring features and performing device tasks, and where to find the features and settings in the web interface and this guide. Click the page number in the Page column to jump to instructions on configuring or using the feature. Some features are configurable from the command line interface only. In those cases, the commands that configure the feature are noted. The command descriptions are in the *Digi Connect Family Command Reference*.

| Feature/task | Path to feature in the web interface | See page |
|--|--|----------|
| Administration/Configuration management: | | |
| <ul style="list-style-type: none"> ■ File management: uploading and downloading files, such as applet files, and custom splash screens. | Administration > File Management See also the <i>Digi Connect Family Customization and Integration Guide</i> for information on uploading and downloading files used to customized a Digi device's look-and-feel. | 211 |
| <ul style="list-style-type: none"> ■ Python program file management. | Applications > Python | 171 |
| <ul style="list-style-type: none"> ■ Backup/restore a configuration from a TFTP server on the network | Administration > Backup/Restore | 215 |
| <ul style="list-style-type: none"> ■ Update firmware | Administration > Update Firmware | 216 |
| <ul style="list-style-type: none"> ■ Reset configuration to factory defaults | Administration > Factory Default Settings | 217 |
| <ul style="list-style-type: none"> ■ System information, including device identifiers and statistics | Administration > System Information | 220 |
| <ul style="list-style-type: none"> ■ Reboot the Digi device | Administration > Reboot | 220 |
| <ul style="list-style-type: none"> ■ Certificate and key management, including X.509, VPN, SSL, SSH | Administration > X.509 Certificate and Key Management | 212 |
| Alarms | Configuration > Alarms | 151 |
| Autoconnection: automatically connect a user to a server or network device | Configuration > Serial Ports > port > Profile Settings > TCP Sockets > Automatically establish TCP connections | 143 |
| Camera settings | Configuration > Camera | 150 |

| Feature/task | Path to feature in the web interface | See page |
|--|--|-----------------|
| Connection management: | | |
| ■ Manage serial port connections | Management > Serial Ports | 202 |
| ■ Manage Virtual Private Network (VPN) connections | Management > Connections > Virtual Private Network (VPN) Settings | 202 |
| ■ Manage active system connections | Management > Connections > Active System Connections | 202 |
| ■ Manage network services | Management > Network Services (Currently only DHCP server settings managed from here) | 203 |
| Domain Name System (DNS): | | |
| ■ DNS Client | Configuration > Network > Advanced Network Settings | 103 |
| ■ Dynamic DNS (DDNS) update | Configuration > Network > Dynamic DNS Update Settings | 78 |
| Dynamic Host Configuration Protocol (DHCP) server | To configure a DHCP server: Configuration > Network > DHCP Server Settings To start and stop and show status of a DHCP server: Management > Network Services > DHCP Server Management | 71 |
| Ethernet settings | Configuration > Network > Advanced Network Settings | 103 |
| Event logging for the Digi device | Management > Event Logging | 202 |
| Help on configuring features | Help button on each page. | |
| Host name for a device | Configuration > Network > Advanced Network Settings > Host Name | 103 |
| Industrial Automation (IA) | Configuration > Serial Ports > Select Port Profile > Industrial Automation The Industrial Automation port profile should address most configuration scenarios. To fine-tune your IA settings, use the “set ia” command from the command line. See the set ia command description in the <i>Digi Connect Family Command Reference</i> . For additional information on configuring Industrial Automation, see this web site: http://www.digi.com/support/ia | 177 |
| IP address settings | Configuration > Network > IP Settings Configuration > Network > Advanced Settings | 48, 66, 71, 103 |
| IP filtering / access control | Configuration > Network > IP Filtering Settings | 81 |

| Feature/task | Path to feature in the web interface | See page |
|--|---|----------|
| IP forwarding: Network Address Translation (NAT) and port forwarding configuration/static routes | Configuration > Network > IP Forwarding Settings | 82 |
| IP pass-through | Configuration > Network > IP Pass-through | 90 |
| Mobile (cellular) settings: | | |
| <ul style="list-style-type: none"> ■ Provisioning the cellular modules | <p>Configuration > Mobile</p> <p>For Digi Cellular product that have a cellular module, provisioning must be performed once.</p> <p>To launch a wizard for provisioning the module, go to Configuration > Mobile. Under Mobile Service Provider Settings, click the Provision Device button.</p> <p>Provisioning can also be performed from the command line:</p> <ul style="list-style-type: none"> ■ To provision the CDMA module: provision ■ To display existing provisioning parameters: display provisioning | 110 |
| <ul style="list-style-type: none"> ■ Mobile service provider and connection settings | <p>Configuration > Mobile</p> <p>Settings displayed vary by mobile service provider.</p> | 109, 116 |
| <ul style="list-style-type: none"> ■ SureLink™ settings | Configuration > Mobile > SureLink Settings. | 116 |
| <ul style="list-style-type: none"> ■ Short Message Service (SMS) settings | Configuration > Mobile > Short Message Service (SMS) Settings | 121 |
| Modem emulation | <p>Configuration > Serial Ports > Port Profile Settings > Modem Emulation</p> <p>See the <i>Connect Family Command Reference</i> for modem emulation commands.</p> | 145 |
| Port profiles: sets of preconfigured serial-port settings for a particular connection and use scenario | Configuration > Serial Ports > Port Profile Settings | 141 |
| Python support: loading and running custom programs authored in the Python programming language. | <p>Applications > Python</p> <p>For more information on writing and running Python programs, see the <i>Digi Python Programming Guide</i>.</p> | 171 |
| RealPort (COM port redirection) configuration | <p>Configuration > Serial Ports > port > Port Profile Settings > RealPort</p> <p>See also the <i>RealPort Installation Guide</i>.</p> | 142 |
| Remote device management | Configuration > Remote Management | 161 |
| Reverting configuration settings | Administration > Factory Default Settings | 217 |

| Feature/task | Path to feature in the web interface | See page |
|---|--|----------|
| Security/access control features: | | |
| <ul style="list-style-type: none"> ■ Control access to inbound ports | Configuration > Serial Ports > <i>port</i> > Port Profile Settings > TCP Sockets or UDP Sockets or Custom port profile | 141 |
| <ul style="list-style-type: none"> ■ Secure Shell Server (SSH) | Configuration > Security > Enable SSH public key authentication Network > Network Services > Enable Secure Shell Server (SSH) | 168, 76 |
| <ul style="list-style-type: none"> ■ Establish/change user name for a user | Configuration > Security | 166 |
| <ul style="list-style-type: none"> ■ Issue a new/changed password to a user | Configuration > Security | 166 |
| Serial port configuration: | | |
| <ul style="list-style-type: none"> ■ Basic serial port settings | Configuration > Serial Ports > Basic Serial Settings | 146 |
| <ul style="list-style-type: none"> ■ Advanced serial port settings | Configuration > Serial Ports > Advanced Serial Settings | 147 |
| <ul style="list-style-type: none"> ■ Port profiles: associate a serial port with a set of preconfigured port settings for a specific use | Configuration > Serial Ports > Port Profile Settings | 141 |
| <ul style="list-style-type: none"> ■ RCI over serial mode | Configuration > Serial Ports > Advanced Serial Settings | 147 |
| <ul style="list-style-type: none"> ■ RTS Toggle | Configuration > Serial Ports > Advanced Serial Settings | 147 |
| <ul style="list-style-type: none"> ■ TCP serial connections | Configuration > Serial Ports > <i>port</i> > Port Profile Settings > TCP Sockets port profile | 143 |
| <ul style="list-style-type: none"> ■ UDP serial characteristics | Configuration > Serial Ports > <i>port</i> > Port Profile Settings > UDP Sockets port profile | 144 |

| Feature/task | Path to feature in the web interface | See page |
|---|--|----------|
| Simple Network Management Protocol (SNMP): | | |
| <ul style="list-style-type: none"> ■ Configure SNMP through the web interface | Configuration > System > Simple Network Management Protocol (SNMP) Settings | 158 |
| <ul style="list-style-type: none"> ■ Enable/disable SNMP service | Configuration > Network > Network Services | 75 |
| <ul style="list-style-type: none"> ■ Enable/disable SNMP alarm traps | Configuration > Alarms > alarm > Send SNMP trap to following destination when alarm occurs | 153, 154 |
| <ul style="list-style-type: none"> ■ Use SNMP as primary configuration interface | Basic network and serial settings configurable through standard and Digi-specific Management Information Blocks (MIBs). More advanced settings must be set through the web or command-line user interfaces, and sending alarms as SNMP traps must be configured through the web interface, on the pages listed above. | 35181 |
| System information: assign system-identifying information to a device | Configuration > System > Device Identity Settings | 155 |
| Socket Tunnel Settings | Configuration > Network > Socket Tunnel Settings | 89 |
| Statistics for Digi devices | Administration > System Information | 184 |
| Status of Digi devices | Management > Serial Ports, Connections, Network Services | 202 |
| VPN (Virtual Private Network) | To configure VPN: Configuration > Network > Virtual Private Network (VPN) Settings To manage VPN: Management > Connections > Virtual Private Network (VPN) Connections | 90 |
| Wi-Fi (wireless LAN) devices: | | |
| Wireless LAN Settings | Configuration > Network > WiFi LAN Settings | 67 |
| Wireless Security Settings | Configuration > Network > WiFi Security Settings | 68 |
| Wireless 802.1x Authentication Settings | Configuration > Network > WiFi 802.1x Settings | 70 |

| Feature/task | Path to feature in the web interface | See page |
|---|--|----------|
| XBee wireless network configuration and management: | | |
| <ul style="list-style-type: none"> ■ XBee network configuration through web UI | Configuration > XBee Network | 131 |
| <ul style="list-style-type: none"> ■ XBee network configuration through the iDigi Platform | In the iDigi Platform, the XBee Networks view | 53 |
| <ul style="list-style-type: none"> ■ XBee network monitoring/management through web UI | Administration > System Information > XBee Network See also the iDigi Platform's XBee Networks view and detailed view of network nodes. | 197 |
| <ul style="list-style-type: none"> ■ XBee network monitoring/management through command line | set xbee display xbee info zigbee_sockets xbee | 183 |

Hardware features

A summary of hardware features, including power-supply information, is in "Hardware specifications" on page 223.

Network interface features

A detailed list of network interface features is in Chapter 6, "Specifications and certifications". See also the data sheet for your Digi product.

Configurable network services

Access to network services can be enabled and disabled. This means that a device's use of network services can be restricted to those strictly needed by the device. To improve device security, non-secure services, such as Telnet, can be disabled.

Network services that can be enabled or disabled include:

- Advanced Digi Discovery Protocol (ADDP): can enable or disable ADDP, but cannot change its network port number.
- RealPort
- Encrypted RealPort
- HTTP/HTTPS
- Line Printer Daemon (LPD)
- Remote Login (rlogin)
- Remote Shell (rsh)
- Simple Network Management Protocol (SNMP)
- Telnet

In the web interface, access to network services is enabled and disabled on the Network Services page of Network Configuration. For more information, see "Network services settings" on page 75. In the command-line interface, network services are enabled and disabled through the **set service** command. See the *Digi Connect Family Command Reference* for the **set service** command description.

IP protocol support

All Digi devices include a Robust on-board TCP/IP stack with a built-in web server. Supported protocols include, unless otherwise noted:

- Transmission Control Protocol (TCP)
- User Datagram Protocol (UDP)
- Dynamic Host Configuration Protocol (DHCP)
- Simple Network Management Protocol (SNMP)
- Secure Sockets Layer (SSL)/Transport Layer Security (TLS)
- Telnet Com Port Control Option (Telnet) including support of RFC 2217 (ability to control serial port through Telnet). See "Serial data communication over TCP and UDP" on page 19 for additional information.
- Remote Login (rlogin)
- Line Printer Daemon (LPD)
- HyperText Transfer Protocol (HTTP)/HyperText Transfer Protocol over Secure Socket Layer (HTTPS)
- Simple Mail Transfer Protocol (SMTP)
- Internet Control Message Protocol (ICMP)
- Internet Group Management Protocol (IGMP)
- Address Resolution Protocol (ARP)
- Advanced Digi Discovery Protocol (ADDP)
- Point to Point Protocol (PPP)
- Network Address Translation (NAT)/Port Forwarding
- Secure Shell (SSHv2)
- Generic Routing Encapsulation (GRE) Passthrough
- IPSec Encapsulating Security Payload (ESP) on most models
- ESP Passthrough

Following is an overview of some of the services provided by these protocols.

Serial data communication over TCP and UDP

Digi devices support serial data communication over TCP and UDP. Key features include:

- Serial data communication over TCP, also known as autoconnect and tcpserial can automatically perform the following functions:
 - Establish bidirectional TCP connections, known as autoconnections, between the serial device and a server or other network device. Autoconnections can be made based on data and or serial hardware signals.
 - Control forwarding characteristics based on size, time, and pattern
 - Allow incoming raw, Telnet, and SSL/TLS (secure-socket) connections
 - Support RFC 2217, an extension of the Telnet protocol
- Serial data communication over UDP, also known as udpserial, can automatically perform the following functions:
 - Digi Connect products can automatically send serial data to one or more devices or systems on the network using UDP sockets. Options for sending data include whether specific data is on the serial line, a specific time period has elapsed, or after the specified number of bytes has been received on the serial port.
 - Control forwarding characteristics based on size, time, and patterns.
 - Support incoming datagrams from multiple destinations.
 - Support outgoing datagrams sent to multiple destinations.
- TCP/UDP forwarding characteristics.
- Extended communication control on TCP/UDP data paths.
 - Timeout
 - Hangup
 - User-configurable Socket ID string (text string identifier on autoconnect only)

Dynamic Host Configuration Protocol (DHCP)

Dynamic Host Configuration Protocol (DHCP) can be used to automatically assign IP addresses, deliver TCP/IP stack configuration parameters such as the subnet mask and default router, and provide other configuration information. For further details, see "Configure an IP address using DHCP" on page 48.

Auto-IP

Auto-IP is a protocol that will automatically assign an IP address from a reserved pool of standard Auto-IP addresses to the computer on which it is installed. For Digi devices are set to obtain its IP address automatically from a DHCP server and the DHCP server is unavailable or nonexistent, Auto-IP will assign the device an IP address. For further details, see "Configure an IP address using Auto-IP" on page 48.

Simple Network Management Protocol (SNMP)

Simple Network Management Protocol (SNMP) is a protocol for managing and monitoring network devices. SNMP architecture enables a network administrator to manage nodes--servers, workstations, routers, switches, hubs, etc.--on an IP network; manage network performance, find and solve network problems, and plan for network growth. Digi devices support SNMP Versions 1 and 2. For more information on SNMP as a device-management interface, see "Simple Network Management Protocol (SNMP)" on page 35. For a list of supported Request for Comments (RFCs) and Management Information Bases (MIBs), see page 158.

Secure Sockets Layer (SSL)/Transport Layer Security (TLS)

Secure Sockets Layer (SSL)/Transport Layer Security (TLS) are used to provide authentication and encryption for Digi devices. For more information, see "Security features" on page 24.

Telnet

Digi devices support the following types of Telnet connections:

- Telnet Client
- Telnet Server
- Reverse Telnet, often used for console management or device management
- Telnet Autoconnect
- RFC 2217, Telnet Com Port Control Option, an extension of the Telnet protocol

For more information on these connections, see "Supported connections and data paths in Digi devices" on page 26. Access to Telnet network services can be enabled or disabled.

Remote Login (rlogin)

Users can perform logins to remote systems (rlogin). Access to rlogin service can be enabled or disabled.

Line Printer Daemon (LPD)

The Line Printer Daemon (LPD) allows network printing over a serial port. Each serial port has a dedicated LPD server that is independently configurable. Access to LPD service can be enabled or disabled.

HyperText Transfer Protocol (HTTP)***HyperText Transfer Protocol over Secure Socket Layer (HTTPS)***

Digi devices provide web pages for configuration that can be secured by requiring a user login.

Internet Control Message Protocol (ICMP)

ICMP statistics can be displayed, including the number of messages received, bad messages received, and destination unreachable messages received.

Point-to-Point Protocol (PPP)

The Point-to-Point Protocol (PPP) transports multi-protocol packets over point-to-point links. PPP encapsulates the data packet, allows the server to inform the dial-up client of its IP address (or client to request the IP address), authenticates the exchange, negotiates multiple protocols, and reassembles the data packet for network communication. ConnectPort X Family devices support PPP as the connection protocol from the Digi device to the cellular IP network with NAT (Network Address Technology).

Network Address Translation (NAT)/Port Forwarding

Network Address Translation (NAT) reduces the need for a large amount of publicly known IP addresses by creating a separation between publicly known and privately known IP addresses.

Advanced Digi Discovery Protocol (ADDP)

The Advanced Digi Discovery Protocol (ADDP) runs on any operating system capable of sending multicast IP packets on a network. ADDP allows the system to identify all ADDP-enabled Digi devices attached to a network by sending out a multicast packet. The Digi devices respond to the multicast packet and identify themselves to the client sending the multicast.

ADDP communicates with the TCP/IP stack using UDP. The TCP/IP stack should be able to receive multicast packets and transmit datagrams on a network.

Not all Digi devices support ADDP. Access to ADDP service can be enabled or disabled, but the network port number for ADDP cannot be changed from its default.

***Generic Routing Encapsulation (GRE) Passthrough
Encapsulating Security Payload (ESP)
ESP Passthrough***

Generic Routing Encapsulation (GRE) and Encapsulating Security Payload (ESP) are routing protocols that are used to route (tunnel) various types of information between networks.

GRE applies to the encapsulation of IP datagrams tunneled through the internet. The encapsulation includes security, typically in the form of IPSec (IP security), and is most commonly found in VPN (Virtual Private Network) implementation. RFC (Request For Comment) 1701 and 1702 define these standards. Similarly, ESP is used in conjunction with IPsec as a possible way of carrying IP packets for a Virtual Private Network (VPN) setup. ESP is defined in RFC 2406.

In ESP Passthrough and GRE Passthrough, inbound IPsec ESP or GSP protocol traffic is forwarded from to a VPN device connected to the Digi device's Ethernet port.

Note: If an Auto-key Internet Key Exchange (IKE)-based VPN is used, UDP port 500 must also be forwarded.

Mobile/Cellular features and protocol support

Key cellular features in cellular-enabled Digi devices include:

- GSM: GPRS, EDGE, UMTS, HSPA, SMS
- CDMA: 1xRTT, Ev-DO (Revs 0 and A)
- IPSec ESP / IKE
- IP Pass-through, also known as bridge mode
- 3-5 Volt SIM card
- Signal-strength LEDs

Provisioning wizard

For Digi devices equipped with a Code-Division Multiple Access (CDMA)-based cellular modem, the Mobile Device Provisioning Wizard is available in the web interface to properly configure the Digi device with the required configuration used to access the mobile network. The wizard allows for both automatic and manual provisioning for a variety of mobile service providers.

Digi SureLink™

Digi Connect Family, Digi Cellular Family, and ConnectPort X Family products support the Digi SureLink™ feature. Digi SureLink provides an “always-on” mobile network connection to ensure that a Digi device is in a state where it can connect to the network. It does this through hardware reset thresholds and periodic tests of the connection.

Mobile/Cellular protocols

Mobile/cellular protocols supported include, unless otherwise noted:

- Global System for Mobile communication (GSM)
- General Packet Radio Service (GPRS)
- Enhanced Data Rates for GSM Evolution (EDGE)
- Universal Mobile Telecommunications Service (UMTS)
- High Speed Packet Access (HSPA)
- Code-Division Multiple Access (CDMA)
- Evolution-Data Optimized (EV-DO, EVDO, or 1xEV-DO)
- Short Message Service (SMS), currently for GSM cellular products only. Digi cellular gateways implement an SMS-based protocol that allows managing devices by sending SMS commands from anywhere SMS messages can be sent. See "Short Message Service (SMS) settings" on page 121.

RealPort software

Digi devices use the patented RealPort COM/TTY port redirection for Microsoft Windows. RealPort software provides a virtual connection to serial devices, no matter where they reside on the network. The software is installed directly on the host PC and allows applications to talk to devices across a network as though the devices were directly attached to the host. Actually, the devices are connected to a Digi device somewhere on the network.

RealPort is unique among COM port re-directors because it is the only implementation that allows multiple connections to multiple ports over a single TCP/IP connection. Other implementations require a separate TCP/IP connection for each serial port. Unique features also include full hardware and software flow control, as well as tunable latency and throughput.

Access to RealPort services can be enabled or disabled.

Encrypted RealPort

Digi devices also support RealPort software with encryption. Encrypted RealPort offers a secure Ethernet connection between the COM or TTY port and a device server or terminal server. Encryption prevents internal and external snooping of data across the network by encapsulating the TCP/IP packets in a Secure Sockets Layer (SSL) connection and encrypting the data using Advanced Encryption Standard (AES), one of the latest, most efficient security algorithms. Access to Encrypted RealPort services can be enabled or disabled.

Digi's RealPort with encryption driver has earned Microsoft's Windows Hardware Quality Lab (WHQL) certification. Drivers are available for a wide range of operating systems, including Microsoft Windows Server 2003, Windows XP, Windows 2000, Windows NT, Windows 98, Windows ME; SCO Open Server; Linux; AIX; Sun Solaris SPARC; Intel; and HP-UX. It is ideal for financial, retail/point-of-sale, government or any application requiring enhanced security to protect sensitive information.

Alarms

Digi devices can be configured to issue alarms, in the form of email message or SNMP traps, when certain device events occur. These events include certain data patterns being detected in the data stream, and cellular alarms for signal strength and amount of cellular traffic for a given period of time. Receiving alarms about these conditions provides the advantage of notifications being issued when events occur, rather than having to monitor the device on an ongoing basis to determine whether these events have occurred. Alarms can also be forwarded to the iDigi platform for display and management in that platform. For more information on configuring alarms, see "Alarms" on page 151.

Modem emulation

Digi devices include a configuration profile that allows the device to emulate a modem. Modem emulation sends and receives modem responses to a serial device over TCP/IP (including Ethernet and Cellular instead of Public Switched Telephone Network (PSTN)). The modem emulation profile allows maintaining a current software application but using it over the less expensive Ethernet network. In addition, Telnet processing can be enabled or disabled on the incoming and outgoing modem-emulation connections. The modem-emulation commands supported in Digi devices are documented in the *Digi Connect Family Command Reference*.

Security features

Security-related features in Digi devices include:

Secure access and authentication

- One password, one permission level.
- Can issue passwords to device users.
- Can selectively enable and disable network services such as ADDP, RealPort, Encrypted RealPort, HTTP/HTTPS, LPD, Remote Login, Remote Shell, SNMP, and Telnet.
- Can control access to inbound ports.
- Secure sites for configuration: HTML pages for configuration have appropriate security.
- Can control access to specific devices, IP addresses, or networks through IP filtering.

Encryption

- Strong Secure Sockets Layer (SSL) V3.0/ Transport Layer Security (TLS) V1.0-based encryption: DES (64-bit), 3DES (192-bit), AES (128-/192-/256-bit), IPsec ESP: DES, 3DES, AES.
- Encrypted RealPort offers encryption for the Ethernet connection between the COM/TTY port and the Digi device. Encryption prevents internal and external snooping of data across the network by encapsulating the TCP/IP packets in a Secure Sockets Layer (SSL) connection and encrypting the data using the Advanced Encryption Standard (AES) security algorithm.

SNMP security

- Authorization: Changing public and private community names is recommended to prevent unauthorized access to the device.
- SNMP “set” commands can be disabled to make use of SNMP read-only.

Configuration management

Once a Digi device is configured and running, configuration-management tasks need to be periodically performed, such as:

- Upgrading firmware
- Copying configurations to and from a remote host
- Software and factory resets
- Rebooting the device
- Memory management
- File management

For more information on these configuration-management tasks, see Chapter 5, "Digi device administration".

Customization capabilities

Several aspects of using Digi devices can be customized. For example:

- The look-and-feel of the device interface can be customized, to use a different company logo or screen colors.
- Custom applications written in Python can be executed.
- Custom factory defaults to which devices can be reverted can be defined.

The *Digi Connect Family Customization and Integration Guide* (Part Number 90000734; available with the Digi Connect Integration Kit) describes customization and integration tools and processes. Contact Digi International for more information on the Digi Connect Integration Kit customization tools and resources and for assistance with customization efforts.

Supported connections and data paths in Digi devices

Digi devices allow for several kinds of connections and paths for data flow between the Digi device and other entities. These connections can be grouped into two main categories:

- *Network services*, in which a remote entity initiates a connection to a Digi device.
- *Network/serial clients*, in which a Digi device initiates a network connection or opens a serial port for communication.

This discussion of connections and data paths may be helpful in understanding the effects of enabling certain features and choosing certain settings when configuring Digi products.

Network services

A network service connection is one in which a remote entity initiates a connection to a Digi device. There are several categories of network services:

- Network services associated with specific serial ports
- Network services associated with serial ports in general
- Network services associated with the command-line interface (CLI)

Network services associated with specific serial ports

- Reverse Telnet: A telnet connection is made to a Digi device, in which data is passed transparently between the telnet connection and a named serial port.
- Reverse raw socket: A raw TCP socket connection is made to a Digi device, in which data is passed transparently between the socket and a named serial port.
- Reverse TLS socket: An encrypted raw TCP socket is made to a Digi device, in which data is passed transparently to and from a named serial port.
- LPD: A TCP connection is made to a named serial port, in which the Digi device interprets the LPD protocol and sends a print job out of the serial port.
- Modem emulation, also known as Pseudo-modem (pmodem): A TCP connection is made to a named serial port, and the connection will be “interpreted” as an incoming call to the pseudo-modem.

Network services associated with serial ports in general

- RealPort: A single TCP connection manages (potentially) multiple serial ports.
- Modem emulation, also known as pseudo-modem (pool): A TCP connection to the “pool” port is interpreted as an incoming call to an available pseudo-modem in the “pool” of available port numbers.
- rsh: Digi devices support a limited implementation of the Remote shell (rsh) protocol, in that a single service listens to connections and allows a command to be executed. Only one class of commands is allowed: a single integer that specifies which serial port to connect to. Otherwise, the resulting connection is somewhat similar to a reverse telnet or reverse socket connection.
- DialServ: Connecting a DialServ device to the serial port. DialServ simulates a public switched telephone network (PSTN) to a modem and forwards the data to the serial port. The Digi device sends and receives the data over an IP network.

Network services associated with the command-line interface

- Telnet: A user can Telnet directly to a Digi device’s command-line interface.
- rlogin: A user can perform a remote login (rlogin) to a Digi device’s command-line interface.

Network/serial clients

A network/serial client connection is one in which a Digi device initiates a network connection or opens a serial port for communication. There are several categories of network/serial client connections:

- Autoconnect behavior client connections
- Command-line interface (CLI)-based clients
- Modem emulation (pseudo-modem) client connections

Autoconnect behavior client connections

In client connections that involve autoconnect behaviors, a Digi device initiates a network connection based on timing, serial activity, or serial modem signals. Autoconnect-related client connections include:

- Raw TCP connection: The Digi device initiates a raw TCP socket connection to a remote entity.
- Telnet connection: The Digi device initiates a TCP connection using the Telnet protocol to a remote entity.
- Raw TLS encrypted connection: The Digi device initiates an encrypted raw TCP socket connection to a remote entity.
- Rlogin connection: The Digi device initiates a TCP connection using the rlogin protocol to a remote entity.

Command-line interface (CLI)-based client connections

Command-line interface based client connections are available for use once a user has established a session with the Digi device's CLI. CLI-based client connections include:

- telnet: A connection is made to a remote entity using the Telnet protocol.
- rlogin: A connection is made to a remote entity using the Rlogin protocol.
- connect: Begin communicating with a local serial port.

Modem emulation (pseudo-modem) client connections

When a port is in the modem-emulation or pseudo-modem mode, it can initiate network connections based on AT command strings received on the serial port. The AT commands for modem emulation are documented in the *Digi Connect Family Command Reference*.

Interfaces for configuring, monitoring, and administering Digi devices

There are several interfaces for configuring, monitoring, and administering Digi devices. These interfaces are covered in more detail later in this guide.

Configuration capabilities

Device configuration involves setting values and enabling features for such areas as:

- Network configuration: Specifying the device's IP address settings, network-service settings, and advanced network settings.
- Mobile (cellular) configuration: Specifying the mobile service provider and mobile connection settings for the device.
- Serial port configuration: Specifying the serial port characteristics for the device.
- Alarms: Defining whether alarms should be issued, the conditions that trigger alarms, and how the alarms should be delivered.
- Security/Users configuration: Configuring security features, such as whether password authentication is required for device users.
- System configuration: Specifying system-identifying information, such as a device description, contact person, and physical location.

Configuration interfaces

Several interfaces are available for configuring Digi devices, including:

- The Digi Device Discovery Utility, which locates Digi devices on a network, and allows opening the web interface for the devices.
- The iDigi platform, a configuration interface to fine-tune or monitor devices. The iDigi Platform cannot assign an IP address but it can change one.
- A web-based interface embedded with the product, providing device configuration profiles for quick serial-port configuration and other settings.
- A command-line interface (CLI).
- Remote Command-line Interface (RCI) protocol
- Simple Network Management Protocol (SNMP).

Digi Device Discovery utility

The Digi Device Discovery utility locates Digi devices on a network and allows for opening the web interface for discovered devices, configuring network settings, and rebooting the device. It uses a Digi International-proprietary protocol, Advanced Digi Discovery Protocol (ADDP), to discover the Digi devices on a network, and displays the discovered devices in a list, for example:

| IP Address | MAC Address | Name | Device |
|--------------|-------------------|------|------------------------------|
| 10.8.16.10 | 00:04:F3:01:D8:CF | | ConnectPort X5 R ZB GPRS5 |
| 10.8.16.12 | 00:40:9D:32:E1:F7 | | ConnectPort X8 |
| 10.8.16.14 | 00:40:9D:3C:1E:0F | | ConnectPort X4 |
| 10.8.16.20 | 00:40:9D:3A:41:C8 | | ConnectPort X2 |
| 10.8.16.31 | 00:40:9D:3D:23:E0 | | Connect WAN 3G (RS232 serial |
| 10.8.16.35 | 00:40:9D:23:87:8B | | PortServer TS 16 |
| 10.8.16.40 | 00:40:9D:3C:52:EC | | ConnectPort X2 |
| 10.8.16.46 | 00:40:9D:29:78:E6 | | ConnectPort X8 |
| 10.8.16.55 | 00:40:9D:29:8D:33 | | Digi Connect E5 8 5B |
| 10.8.16.57 | 00:40:9D:3B:98:AC | | ConnectPort X2 |
| 10.8.16.66 | 00:40:9D:3B:98:AF | | ConnectPort X2 |
| 10.8.16.76 | 00:40:9D:3B:98:B2 | | ConnectPort X2 |
| 10.8.16.85 | 00:40:9D:29:95:0D | | Digi Connect ME4 |
| 10.8.113.25 | 00:40:9D:33:40:9C | | ConnectPort X8 |
| 10.8.115.11 | 00:40:9D:29:8D:4A | | ConnectPort X4 NEMA |
| 10.8.115.242 | 00:40:9D:28:55:02 | | PortServer TS 16 Rack |
| 10.8.117.8 | 00:40:9D:23:25:A7 | | PortServer TS 2 H |
| 10.8.127.34 | 00:40:9D:23:00:5C | | PortServer TS 4 MEI |
| 10.8.128.5 | 00:40:9D:28:ED:AD | | PortServer TS 16 Rack |

Digi Device Discovery quickly locates Digi devices and basic device information, such as the device's address, firmware revision, and whether it has been configured. It runs on any operating system that can send multicast IP packets to a network. It sends out a User Datagram Protocol (UDP) multicast packet to all devices on the network. Devices supporting ADDP reply to this UDP multicast with their configuration information. Even devices that do not yet have an IP address assigned or are misconfigured for the subnet can reply to the UDP multicast packet and be displayed in device discovery results.

Not all Digi devices support ADDP. Note that Device discovery responses can be blocked by personal firewalls, Virtual Private Network (VPN) software, and certain network equipment. Firewalls will block UDP ports 2362 and 2363 that ADDP uses to discover devices.

Digi Device Discovery is available for downloading from the Digi Support site. After installation, it is available from the **Start** menu. Access to the ADDP service can be enabled or disabled, but the network port number for ADDP cannot be changed from its default. For more information on the Digi Device Discovery utility, see page 58.

iDigi™ Platform interface

The iDigi Platform provides remote network management of all connected hardware. In contrast to the one-user-to-one device model of other Digi device interfaces, the iDigi Platform uses a one-user-to-many-devices interface model. By providing a central point of access to remote devices or groups of devices, the iDigi Platform makes it easier for you to manage many devices. Using a standard Web browser, from the iDigi Platform, you can configure network hardware; track device performance; remotely set filters and alarms; monitor connections, device status and statistics; reboot devices; reset defaults, and remotely upgrade firmware. Because you can diagnose and solve problems from a central site, resulting in fewer maintenance trips to remote locations, iDigi Platform helps you reduce maintenance costs.

| MAC Address | Device ID | IP Address | Device Type | Description | Status | Firmware Level |
|---------------|-------------------|---------------|----------------------|-----------------------|--------------|----------------|
| 00409D-338406 | 00409DFF-FF338406 | ... | Unknown | ... | Disconnected | ... |
| 00409D-295B4C | 00409DFF-FF295B4C | ... | Digi Connect WAN VPN | ... | Disconnected | ... |
| 00409D-282856 | 00409DFF-FF282856 | ... | Digi Connect WAN | ... | Disconnected | ... |
| 00409D-3B98B2 | 00409DFF-FF3B98B2 | ... | ConnectPort X2 | ... | Disconnected | ... |
| 00409D-33875D | 00409DFF-FF33875D | 192.168.1.105 | ConnectPort X8 | Brad's X8 | Disconnected | 2.9.0.7 |
| 00409D-3C1E0F | 00409DFF-FF3C1E0F | 10.8.16.14 | ConnectPort X4 | Light control gateway | Connected | 2.9.1.0 |

The iDigi Platform is a particularly attractive platform for configuring managing XBee devices behind the gateway. It displays all nodes on the XBee network with the ability to query for node profiles, node descriptors, connected endpoints, radio configuration settings radio statistics, bindings, and more.

| Network Gateway | Node Address | Node ID | Module Type | Product Type | Type | Role | Network Address |
|-------------------|-------------------------|---------|-------------|--------------|---------|------|-----------------|
| 00409DFF-FF33875D | 00.13 a2 00 40 0a 38 0a | ... | XBee ZB | X8 Gateway | 0x30001 | ... | 0x0 |
| 00409DFF-FF3C1E0F | 00.13 a2 00 40 0a 53 75 | ... | XBee ZB | X4 Gateway | 0x30002 | ... | 0x0 |

For more information on the iDigi Platform as an remote management interface, see these resources:

- "Remote management settings" on page 161. This section shows how to configure settings within Digi devices so that they can be handled through a remote device manager such as the iDigi Platform.
- "Configuration through the iDigi Platform" on page 50.
- "Monitoring capabilities from the iDigi Platform" on page 183
- iDigi tutorials and guides

Web interface

A web interface is provided as an easy way to configure and monitor Digi devices. Configurable features are grouped into several categories. These categories vary by product; examples include Network, Serial Port, Alarms, System, Remote Management, Security. Most of the configurable features are arranged by most basic settings on a page, with associated and advanced settings accessible from that page. Serial-port configurations are classified into port profiles, or configuration scenarios that best represents the environment in which the Digi device will be used. Selecting a particular port profile configures the serial port parameters that are needed.

To access the web interface, enter the Digi device's IP address or host name in a browser's URL window. The main menu of the web interface is displayed. For more information, see "Configuration through the web interface" on page 58. The web interface has a tutorial, accessed from the Home page, and online help, accessed from the Help link on each page.

Not all settings provided by the command-line interface are displayed in the web interface.

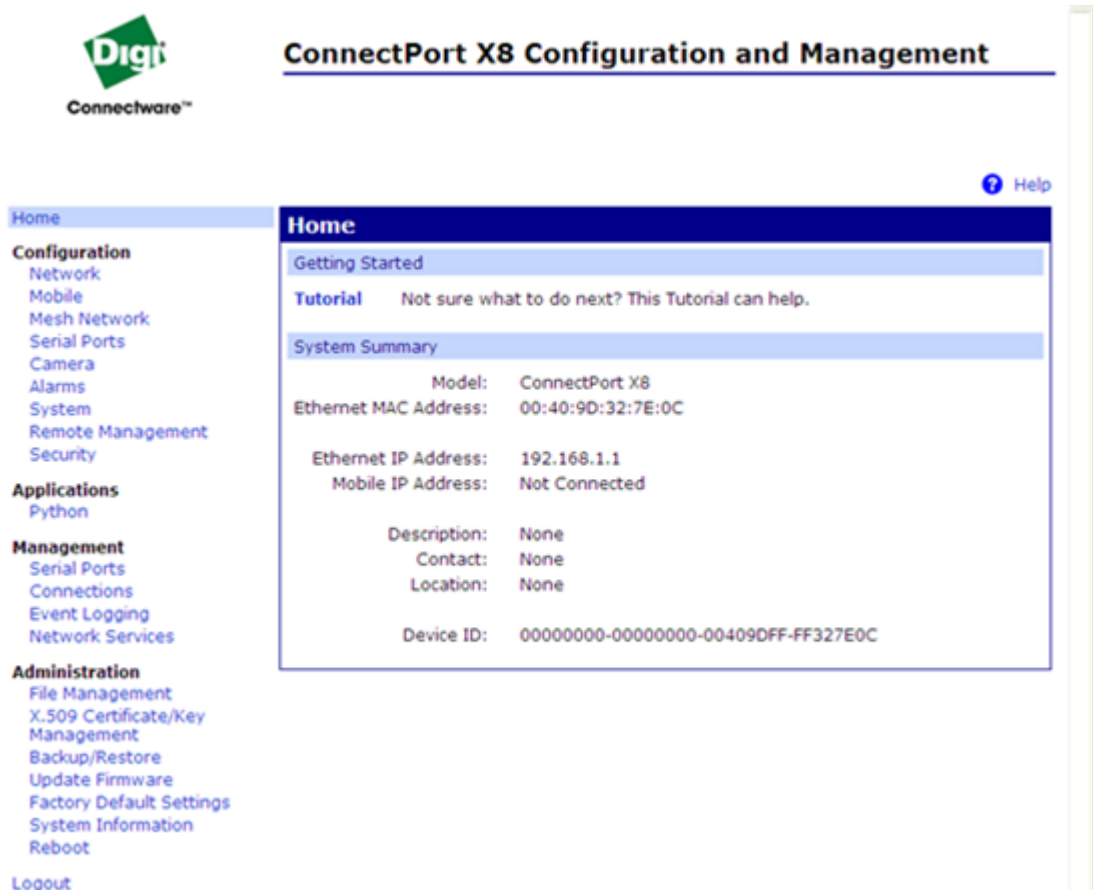

The screenshot displays the web interface for a Digi ConnectPort X8 device. The page title is "ConnectPort X8 Configuration and Management". The Digi logo and "Connectware™" are visible in the top left. A "Help" link is in the top right. The left navigation menu includes sections for Configuration (Network, Mobile, Mesh Network, Serial Ports, Camera, Alarms, System, Remote Management, Security), Applications (Python), Management (Serial Ports, Connections, Event Logging, Network Services), Administration (File Management, X.509 Certificate/Key Management, Backup/Restore, Update Firmware, Factory Default Settings, System Information, Reboot), and Logout. The main content area is titled "Home" and contains a "Getting Started" section with a "Tutorial" link and a "System Summary" section with the following details:

| | |
|-----------------------|-------------------------------------|
| Model: | ConnectPort X8 |
| Ethernet MAC Address: | 00:40:9D:32:7E:0C |
| Ethernet IP Address: | 192.168.1.1 |
| Mobile IP Address: | Not Connected |
| Description: | None |
| Contact: | None |
| Location: | None |
| Device ID: | 00000000-00000000-00409DFF-FF327E0C |

However, the configuration settings in the web interface should be sufficient for most users. If necessary, settings can be modified later from the command line.

Command-line interface

Digi devices can be configured by issuing commands from the command line. The command-line interface allows communication directly without a graphical interface. To access the command line from the Digi Device Discovery utility, click **Telnet to command line**.

For example, here is a command issued from the command line to assign the IP address to the Ethernet interface:

```
#> set network ip=192.168.1.1
```

The command-line interface provides flexibility for making precise changes to device configuration settings and operation. It does require users to have experience issuing commands, and access to command documentation.

The command line is available through Telnet or SSH TCP/IP connections, or through serial port using terminal emulation software such as Hyperterminal. Access to the command line from serial ports depends on the port profile in use by the port. By default, serial port command-line access is allowed.

See "Configuration through the command line" on page 178 for more information on this interface. See the *Digi Connect Family Command Reference* for command descriptions and examples of entering configuration commands from the command-line interface. In addition, online help is available for the commands, through the help and '?' commands.

Remote Command Interface (RCI)

Remote Command Interface (RCI) is a programmatic interface for configuring and controlling Digi devices. RCI is an XML-based request/response protocol that allows a caller to query and modify device configurations, access statistics, reboot the device, and reset the device to factory defaults. Unlike other configuration interfaces that are designed for a user, such as the command-line or web interfaces, RCI is designed to be used by a program. RCI access consists of program calls. A typical use of RCI is in a Java applet that can be stored on the Digi device to replace the web interface with a custom browser interface. Another example is a custom application running on a PC that monitors and controls an installation of many Digi devices.

As RCI is designed to be used by a program, it is useful for creating a custom configuration user interface, or utilities that configure or initialize devices through external programs or scripts.

RCI uses HTTP as the underlying transport protocol. Depending on the network configuration, use of HTTP as a transport protocol could be blocked by some firewalls.

RCI is quite complex to use, requiring users to phrase configuration requests in Extensible Markup Language (XML) format. It is a "power-user" option, intended more for users developing their own user interfaces, or for users implementing embedded control (and thus potentially using RCI over serial) than for end-users with limited knowledge of device programming.

Not all actions in the web interface have direct equivalents in RCI. Therefore, it may not be easy for some end-users to determine what needs to be sent through XML for a particular style of request.

For more details on RCI, see the Digi Connect Integration Kit and the *Remote Command Interface (RCI) Specification*.

Simple Network Management Protocol (SNMP)

Simple Network Management Protocol (SNMP) is a protocol for managing and monitoring network devices. The SNMP architecture enables a network administrator to manage nodes-- servers, workstations, routers, switches, hubs, etc.--on an IP network; manage network performance, find and solve network problems, and plan for network growth. Digi devices support SNMP Versions 1 and 2.

SNMP is easy to implement in extensive networks. Programming new variables and “dropping in” new devices in a network are easy. SNMP is widely used. It is a standard interface that integrates well with network management stations in an enterprise environment. While its capabilities are limited to device monitoring and display of statistics in Digi devices, read/write capabilities are expected to be added to Digi devices in future releases.

However, because device communication is UDP-based, the communication is not secure. If more secure communications with a device are required, use an alternate device interface. SNMP does not allow for certain task that can be performed from the web interface, such as file management, uploading firmware, or backing up and restoring configurations. Compared to the web or command-line interfaces, SNMP is limited in its ability to set specific parameters, such as set port profile, is not possible.

Accessing the SNMP interface requires a tool, such as a network management station. The management station relies on an agent at a device to retrieve or update the information at the device, including Device configuration, status, and statistical information. This information is viewed as a logical database, called a Management Information Base (MIB). MIB modules describe MIB variables for a variety of device types and computer hardware and software components.

A variety of resources about SNMP are available, including reference books, overviews, and other files on the Internet. For an overview of the SNMP interface and the components of MIB-II, go to <http://www.rfc-editor.org/rfcsearch.html>, and search for MIB-II. From the results, locate the text file describing the SNMP interface, titled Management Information Base for Network Management of TCP/IP-based internets: MIB-II. The text of the Digi enterprise MIBs can also be displayed.

For additional discussion of using SNMP as a device monitoring interface, see "Monitoring Capabilities from SNMP" on page 209.

Monitoring capabilities and interfaces

Monitoring Digi devices includes such tasks as checking device status, checking runtime state, viewing serial port operations, and reviewing network statistics, and managing their connections. There are several interfaces for monitoring Digi devices and managing their connections.

As with device configuration, there are several interfaces available for monitoring Digi devices, including, the web interface embedded with the product, SNMP, command-line interface, and the iDigi Platform. These interfaces are covered in more detail in Chapter 4, "Monitor and manage Digi devices"

The iDigi Platform

In the iDigi Platform, monitoring capabilities can be sorted by the server and the devices managed by the server. The information is available in logs and can be generated into reports. When available, the reports post linked totals that can be drilled back to the original devices that make up the activity of the report.

The iDigi Platform is well-suited to managing ConnectPort X Family devices and the networks in which the devices reside. Advantages include the ability to view an entire network, and multiple networks, at once, and ease in viewing signal strength, link quality, and alarms

Web interface

The web interface has several screens for monitoring Digi devices:

- Network Status
- Mobile connection status
- Serial Port Management: for each port, the port's description, current profile, and current serial configuration.
- Connections Management: A display of all active system connections.
- System Information: general device information; serial port information for each port, including the port's description, current profile, and current serial configuration (the same information displayed by choosing Serial Port Management); and network statistics.

Command-line interface

Several commands can be issued from the command line to monitor devices. For a review of these commands and what they can provide from a device-monitoring perspective, see "Monitoring capabilities from the command line" on page 205.

SNMP

Monitoring capabilities of SNMP include managing network performance, gathering device statistics, and finding and solving network problems. For more information on using SNMP for device-monitoring purposes, see "Monitoring Capabilities from SNMP" on page 209.

Device administration

Periodically, administrative tasks need to be performed on Digi devices, such as uploading and managing files, changing the password for logging onto the device, backing up and restoring device configurations, updating firmware, restoring the configuration to factory defaults, and rebooting.

As with configuration and monitoring, administration can be done from a number of interfaces, including the web interface, command line, and the iDigi Platform. See Chapter 5, "Digi device administration" for more information and procedures.

Hardware installation

.....

C H A P T E R 2

This section details requirements and recommendations for installing ConnectPort X Family products.

Hardware installation for ConnectPort X4 H

Connector pinouts

The ConnectPort X4 H has three connectors.

- The 2-pin power connector is properly wired before shipping.
- The 9-pin RS-232, RS-422, and RS-485 connector must be wired by the customer according to the wiring diagram and pinout table.
- The 14-pin input/output connector must also be wired by the customer according to the wiring diagram and pinout table. If you have purchased a 2-analog 2-digital input version of this product, Input/Output 1 and Input/Output 2 are the two analog inputs, and Input/Output 3 and Input/Output 4 are the two digital inputs. Pins 13 and 14 provide power and ground for an optional Ethernet hub.

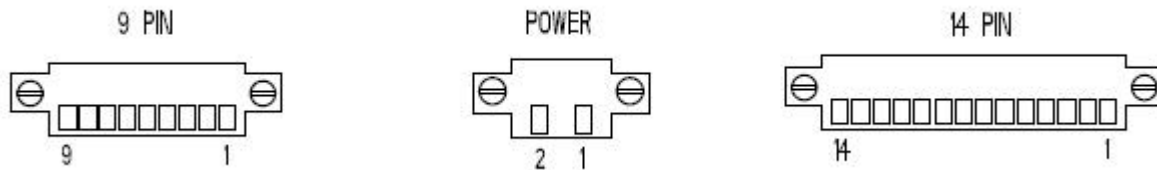

2-pin power connector pinouts

| Pin | Function |
|-----|----------------|
| 1 | +9 to 30 VDC N |
| 2 | GND |

9-pin RS-232, RS-422, and RS-485 connector pinouts

| RS-232 | | RS-422 | | RS-485 | |
|--------|---------------------------|--------|---------------------------|--------|---------------------------|
| Pin | Function | Pin | Function | Pin | Function |
| 1 | CD | 1 | CTS(-) | 1 | CTS(-) |
| 2 | RXD | 2 | RXD(+) | 2 | 485(+) |
| 3 | TXD | 3 | TXD(+) | 3 | N/A |
| 4 | DTR | 4 | RTS(-) | 4 | RTS(-) |
| 5 | GND | 5 | GND | 5 | GND |
| 6 | DSR | 6 | RXD(-) | 6 | 485(-) |
| 7 | RTS | 7 | RTS(+) | 7 | RTS(+) |
| 8 | CTS | 8 | CTS(+) | 8 | CTS(+) |
| 9 | RI | 9 | TXD(-) | 9 | N/A |
| 9 | +12VDC switched power out | 9 | +12VDC switched power out | 9 | +12VDC switched power out |

14-pin input/output connector

| Pin | Function |
|------------|----------------------------|
| 1 | +24VDC sensor power |
| 2 | GND |
| 3 | Input/Output 1 |
| 4 | +24VDC sensor power |
| 5 | GND |
| 6 | Input/Output 2 |
| 7 | +24VDC sensor power |
| 8 | GND |
| 9 | Input/Output 3 |
| 10 | +24VDC sensor power |
| 11 | GND |
| 12 | Input/Output 4 |
| 13 | +24VDC for auxiliary power |
| 14 | GND for auxiliary power |

Cable fittings

To route serial, Ethernet or sensor cables outside the enclosure, and maintain IP66 rating, the three hole plugs can be replaced with cable grips, available in different diameters. These can be purchased separately from Digi.

To wire sensors through cable grips:

- 1 Locate cord grip to attach sensor. Different diameter cord grips are available for different sensors, please contact Digi for purchase.
- 2 Wire sensor to the 14-pin connector plug using the pinout guide provided in the enclosure or in the pinout section on page 39. Up to 4 sensors can be wired into the 14-pin connector.

Note Make sure that all cord grips are tightened and all empty holes are plugged before use to maintain environmental rating.

Antenna options and connectors

ConnectPort X4 H has two antenna connectors, one for cellular networks and the other for XBee networks. Connect the antennas that come with the unit you purchased.

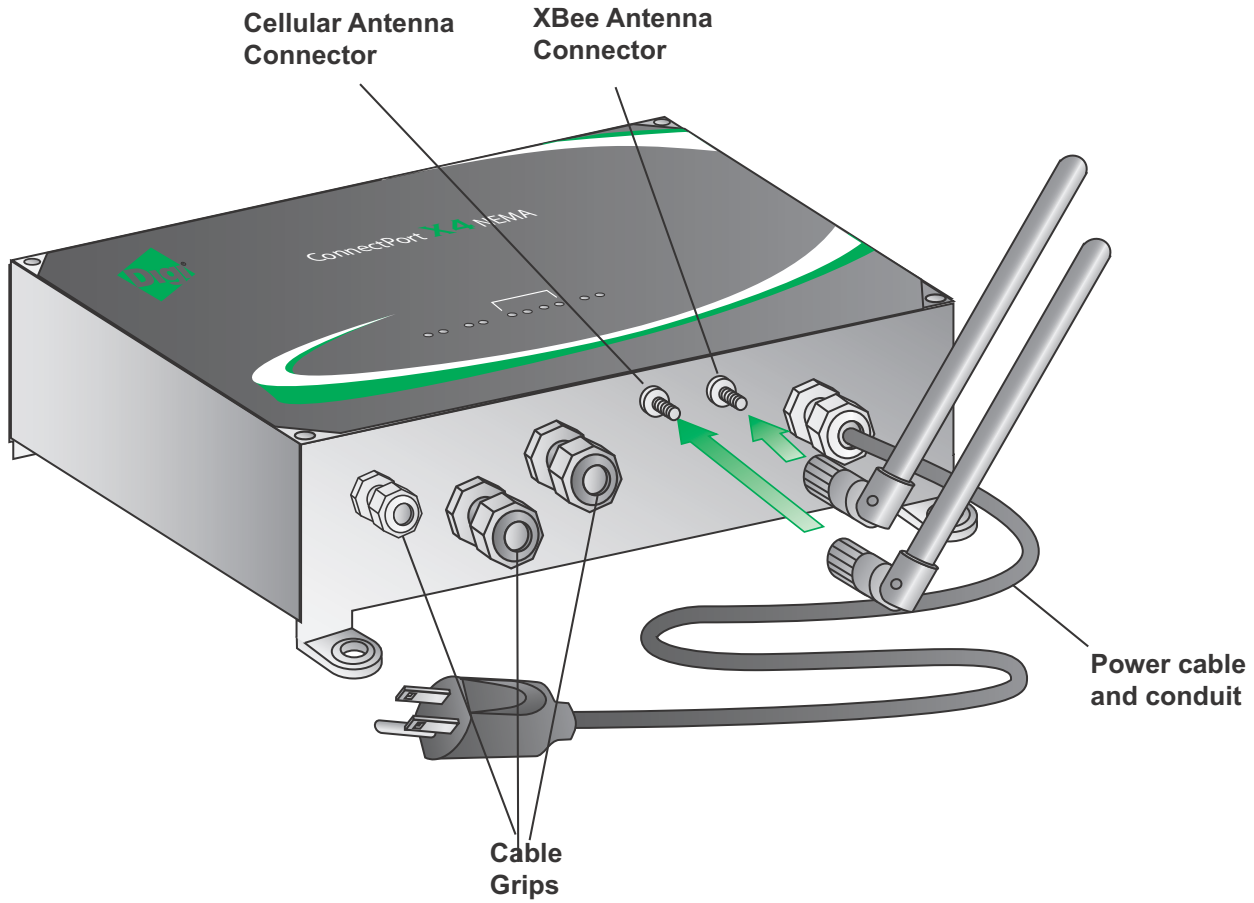

SIM card slots

There are two SIM card slots on the circuit board. If you are only using one SIM, insert it into the primary SIM slot (lower slot).

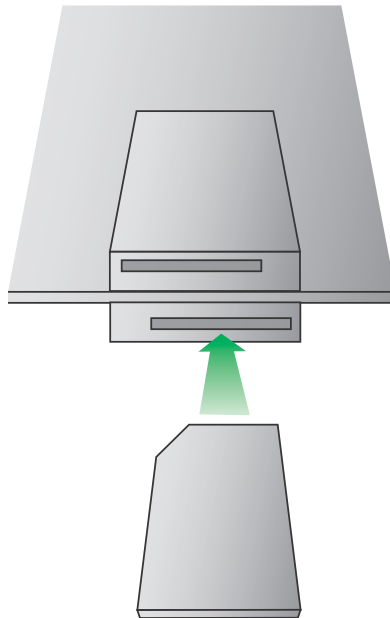
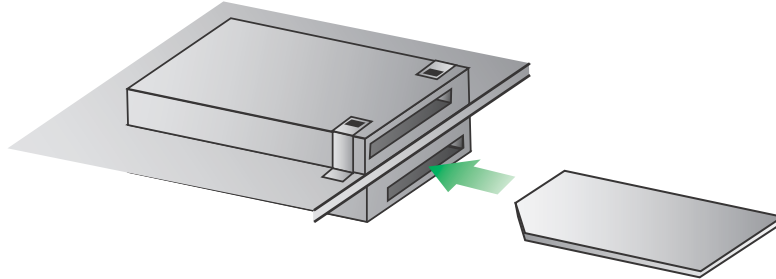

Power cable fitting



Class 1, Div 2 units

Warning Do not plug in or apply power to the unit until all connections are made to the unit in the following steps.

For customers who have purchased a C1D2-approved unit with cable and conduit to wire into the main power supply:

- 1 Make sure that the mains power to the junction box where the cable is to be wired into is off.
- 2 Wire the exposed end of the cable into the junction box using approved C1D2 wiring regulations per National Electrical Code Article 501 (if located in the United States) and other regulations applicable to the locality where it is installed.

See the Power cable wiring table below for information on wiring this cable to the junction box. The mains voltage for this unit needs to be between 100VAC and 240VAC, 50Hz to 60 Hz, and be able to supply a minimum of 24 Watts.

Power cable wiring

| Function | Cable Wire Color | Power Supply Phoenix Connector Pin Number |
|-------------------|------------------|--|
| Frame Ground (FG) | Green | 1 |
| Neutral (N) | White | 2 |
| Line (L) | Black | 3 |

The blue reset button inside the unit can be used to disconnect/reconnect power for units that are hard-wired to power.

Non-Class 1, Div 2 units

For customers who have purchased a non-C1D2 approved unit with a standard power cord with a plug on the end:

The unit can be plugged into a standard matching wall outlet that has an output between 100VAC to 240VAC, 50Hz to 60Hz, and capable of supplying at least 24 Watts.

There are three power-cord options available: U.S.A 120V, European 240V, and U.K. 240V.

Optional Ethernet hub feature

The Ethernet hub for the ConnectPort X4 H is pre-wired to pins 13 and 14 of the 14-pin Phoenix sensor connector for power and ground. It also comes with an Ethernet cable connecting one of the five Ethernet ports to the Ethernet connector in the main board (any port can be used). The remaining four ports can be used as desired.

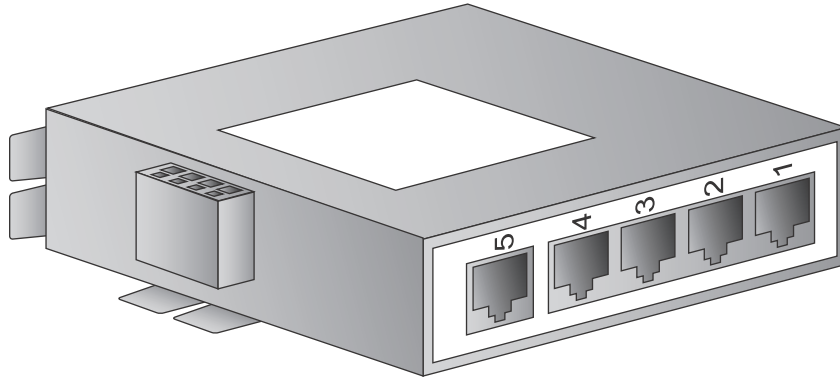

Configure Digi devices

C H A P T E R 3

This chapter describes how to configure a Digi device. It covers these topics:

- Identifying the predefined static IP address for your Digi device on page 48
- "Default IP address and methods for assigning an IP address" on page 48
- "Configuration through the iDigi Platform" on page 50
- "Configuration through the web interface" on page 58
-
- "Configuration through the command line" on page 178
- "Configuration through Simple Network Management Protocol (SNMP)" on page 181
- "Batch capabilities for configuring multiple devices" on page 181

Default IP address and methods for assigning an IP address

All products that have a cellular (WAN) interface ship with static IP address for the Ethernet port of 192.168.1.1 and DHCP *server* enabled by default. Therefore, simply connecting a laptop computer to the Ethernet port of these products allows direct access to the web interface for configuration. The Ethernet port of the laptop should be configured to automatically receive an IP address and DNS server address.

All products that only have an Ethernet or Wi-Fi (LAN) interface ship with DHCP *client* enabled by default. Accessing the web interface on these products is most easily done by connecting it to a LAN that has a DHCP server.

To discover which IP address has been assigned to the device, use the Device Discovery Utility for Windows, available on the Digi Support site. See installation instructions on page 58.

There are several ways to assign an IP address to a Digi device, described on the following pages:

- Use Dynamic Host Configuration Protocol (DHCP) from the web interface.
- Use the command-line interface.
- Use Automatic Private IP Addressing (APIPA), also known as Auto-IP.

Configure an IP address using DHCP

An IP address can also be configured using Dynamic Host Configuration Protocol (DHCP). DHCP is an Internet protocol for automating the configuration of computers that use TCP/IP. DHCP can be used to automatically assign IP addresses and deliver TCP/IP stack configuration parameters.

As mentioned previously, all products that have a cellular (WAN) interface ship with static IP address for the Ethernet port of 192.168.1.1 and DHCP *server* enabled by default. All products that only have an Ethernet or Wi-Fi (LAN) interface ship with DHCP *client* enabled by default.

If desired, set up a permanent entry for the Digi device on a DHCP server. While this is not necessary to obtain an IP address via DHCP, setting up a permanent entry means the IP address is saved when the device is rebooted.

For more information on DHCP server configuration, see "DHCP server settings" on page 71.

Configure an IP address using Auto-IP

The standard protocol Automatic Private IP Addressing (APIPA or Auto-IP) automatically assigns the IP address from a group of reserved IP addresses to the device on which Auto-IP is installed. Use Digi Device Discovery or DHCP to find the Digi device and assign it a new IP address that is compatible with your network. Once the unit is plugged in, Auto-IP automatically assigns the IP address. Auto-IP addresses are typically in the 169.254.x.x address range.

Configure an IP address from the command-line interface

The **set network** command configures an IP address from the command line. Include the following parameters:

- **ip=*device ip***: The IP address for the device.
- **gateway=*gateway***: The network gateway IP address.
- **submask=*device submask***: The device subnet mask.
- **dhcp=off**: Turns off use of the Dynamic Host Configuration Protocol (DHCP), so that the IP address assigned is permanent.
- **static=on**: Specifies that the IP address is static, and will remain as the specified IP address, gateway, and submask.

For example:

```
set network ip=10.0.0.100 gateway=10.0.0.1
submask=255.255.255.0 dhcp=off static=on
```

IP addresses and the iDigi Platform

From the iDigi Platform interface the Ethernet/LAN address for a Digi device can be changed only; an address cannot be assigned. The mobile/cellular device is typically provided by the mobile service provider; check with your mobile service provider on how they handle addresses. To change the IP address, open the web interface for based on the IP address the device has and navigate to **Configuration > Network > IP Settings**. On the IP Settings page, enter the new IP address, subnet mask, and gateway.

Test the IP address configuration

Once the IP address is assigned, make sure it works as configured.

- 1 Access the command line of a PC or other networked device.
- 2 Issue the following command:

```
ping ip-address
```

where *ip-address* is the IP address assigned to the Digi device. For example:

```
ping 192.168.2.2
```

Configuration through the iDigi Platform

The iDigi Platform is an on-demand service. After creating an iDigi account, you can connect to the iDigi Platform. There are no infrastructure requirements. Remote devices and enterprise business applications connect to the iDigi Platform via standards-based Web Services.

Create an Account on iDigi.com

To get started using iDigi, set up an account on the iDigi Platform.

- 1 Navigate to <http://www.idigi.com>.
- 2 Click on the iDigi Platform Login button.
- 3 Click on the **Are you a new user?** link and create your account.



Log in to the iDigi Platform

User Name:

Password:

[Forgot your user name or password?](#)
[Are you a new user?](#)

[Privacy Policy](#) | [Contact us](#)

 iDigi is a [Digi International](#) brand. Copyright © 1996-2009 Digi International Inc. All rights reserved.

Add the Digi device to the iDigi.com Device List

To add your Digi device to the device list, follow these steps:

- 1 Log into the iDigi.com user portal using the username and password you just created. The iDigi Platform interface is displayed.

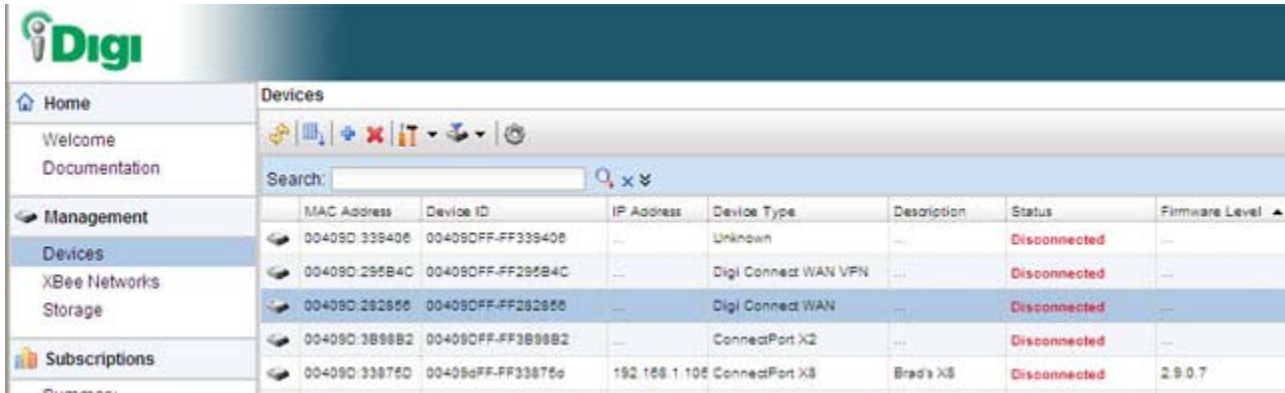

- 2 In the **Devices** list, Click the **+** button on the toolbar to display the **Add Devices** dialog. Locate and select your device from the list of locally discovered devices and click the **OK** button. If your device was not found in the list, check that it is turned on and connected to the same local network as your PC and click the **Refresh** button. Adding your device through automatic discovery informs iDigi about the device and configures that device to connect to the iDigi Connectivity server.

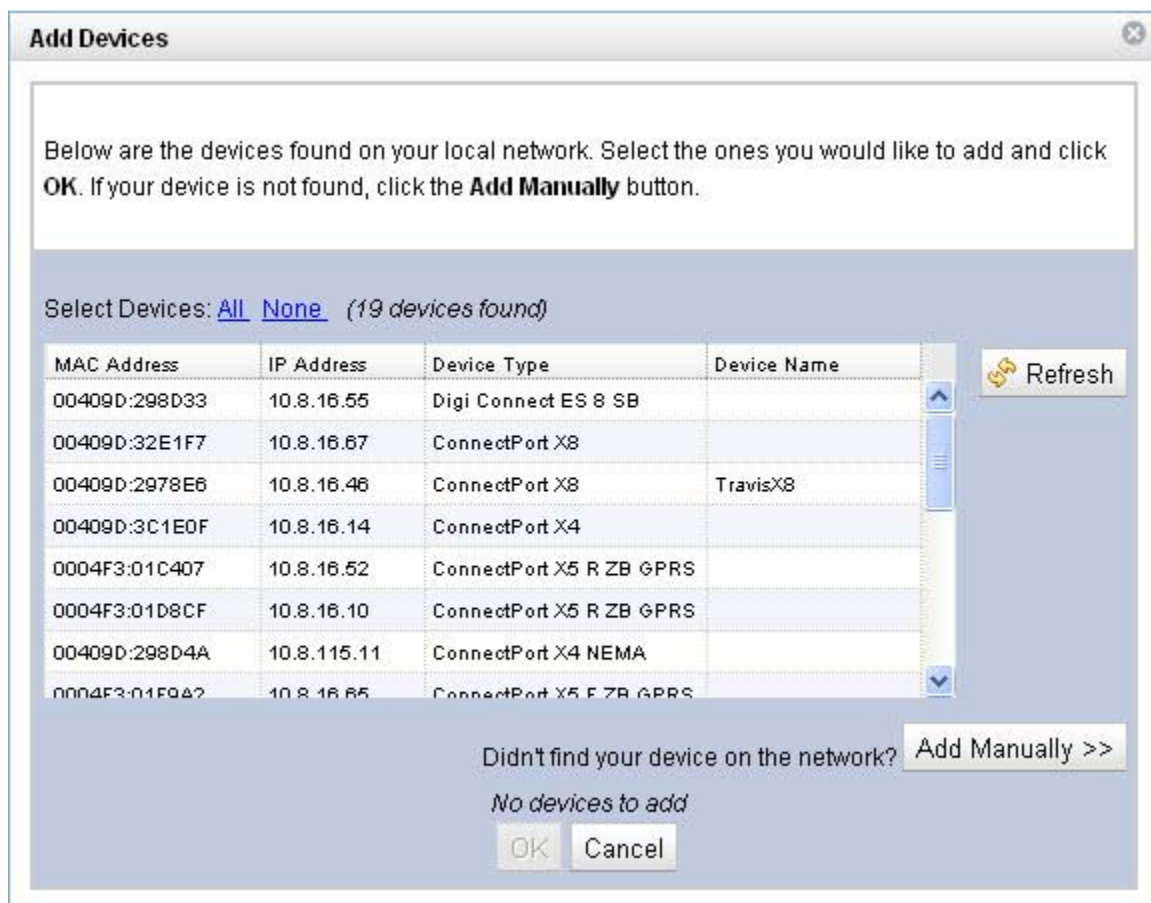

Note If the device is not locally accessible or cannot be automatically discovered, you can still add it by clicking the **Add Manually** button and enter the MAC address found on the bottom of the device. If you manually add your device however, you must also configure the device to connect to the iDigi Connectivity Server. See “Manually configure a Digi device to connect to the iDigi Platform” on page 165.

- 3 Wait a few moments and click the **Refresh** button to ensure that your device status is now Connected.
- 4 Select your device and double-click it, or right-click and select **Properties**.
- 5 Your device information will load into the iDigi Device Manager.

The screenshot displays the iDigi Device Manager interface. On the left is a navigation sidebar with sections: Home (Welcome, Documentation), Management (Devices, XBee Networks, Storage), Subscriptions (Summary, Details), and Administration (My Account, Users, Messages, Operations). The main area is titled 'Devices' and shows a tree view with categories: Home, Ethernet (eth0), Network (XBee, Python), Serial, File Management, Customization, Advanced Configuration, and System Information. A device with MAC address 00409DFF-FF3C1E0F is selected. A 'Properties' window is open on the right, showing the following details:

| | |
|--------------|---|
| Model: | ConnectPort X4 |
| MAC Address: | 00:40:9D:3C:1E:0F |
| Description: | Light control gateway |
| Contact: | BradC |
| Location: | Brad's office |
| Device ID: | 0x00000000000000000000000000409dfff3c1e0f |

At the bottom of the Properties window are buttons for 'Save', 'Export...', 'Refresh', and 'Close'. The status bar at the bottom of the application shows 'Ready' on the left and 'Properties for 00409DFF-FF3C1E0F' on the right.

iDigi Platform views for configuring and managing Digi devices

The iDigi Platform has several views for configuring and managing network devices.

Device list

The iDigi device list displays all the devices in your network. This view allows for viewing and accessing devices regardless of their physical location, even devices behind firewalls. From this view, you can filter and sort device list information, customize the device information displayed, refresh the information, view messages, select one or more devices to configure, manage, and monitor., and add/remove devices and groups.

| MAC Address | Device ID | IP Address | Device Type | Description | Status | Firmware Level |
|---------------|-------------------|---------------|----------------------|-----------------------|--------------|----------------|
| 00409D:339408 | 00409DFF-FF339408 | --- | Unknown | --- | Disconnected | --- |
| 00409D:295B4C | 00409DFF-FF295B4C | --- | Digi Connect WAN VPN | --- | Disconnected | --- |
| 00409D:262856 | 00409DFF-FF262856 | --- | Digi Connect WAN | --- | Disconnected | --- |
| 00409D:3B88B2 | 00409DFF-FF3B88B2 | --- | ConnedPort X2 | --- | Disconnected | --- |
| 00409D:33875D | 00409dFF-FF33875d | 192.168.1.105 | ConnedPort X8 | Brad's X8 | Disconnected | 2.9.0.7 |
| 00409D:3C1E0F | 00409DFF-FF3C1E0F | 10.8.16.14 | ConnedPort X4 | Light control gateway | Connected | 2.9.1.0 |

Device operations menu

In the device list, right-clicking on a selected device displays the device operations menu for performing key device-management tasks, such as file management, restoring the device to factory defaults, updating firmware, and displaying device properties. The image shows the operations menu and the operations available under **Administration** and **Firmware**.

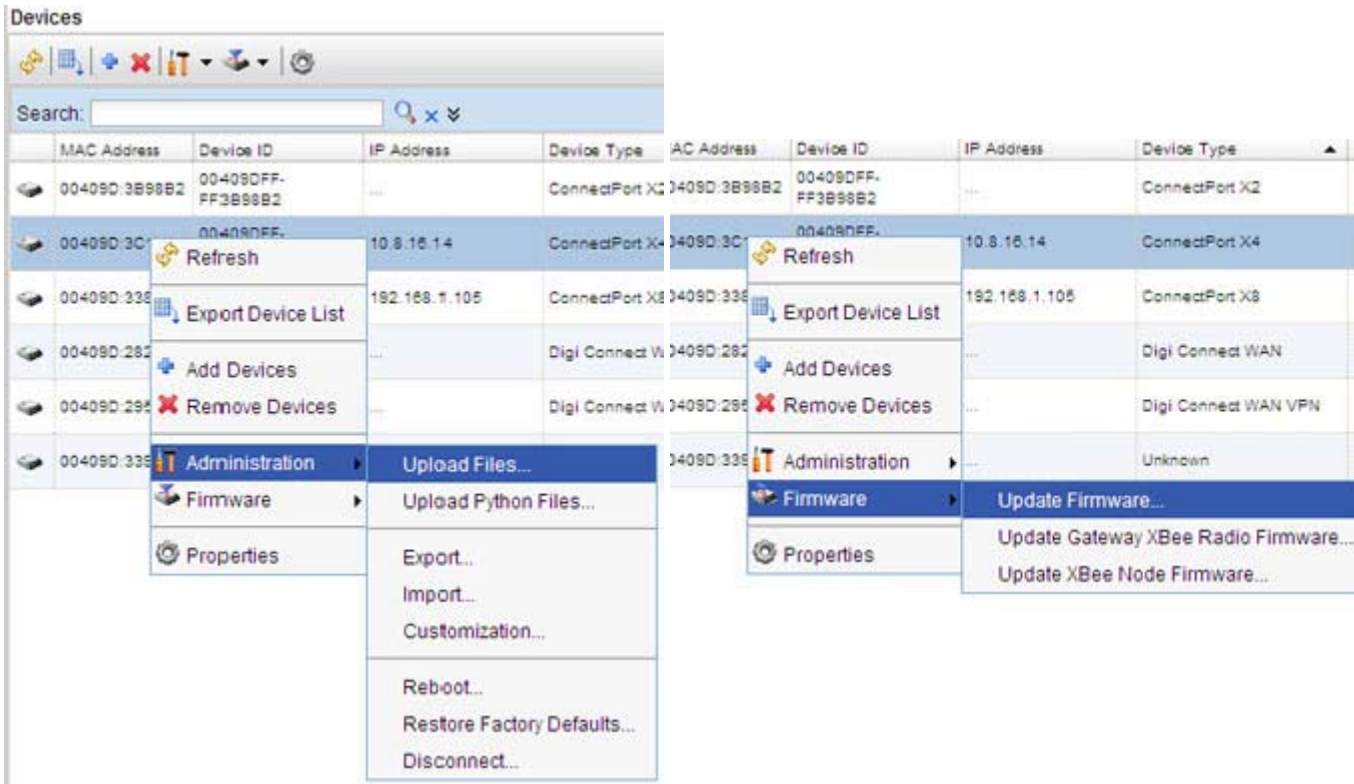

Device properties view

Selecting **Properties** from the device operations menu displays a system summary of the selected device, and a menu of configuration settings, similar to the menu on the home page of the web interface for a Digi device.

Ready Properties for 00409DFF-FF3C1E0F

XBee Networks view

The iDigi Platform is a particularly attractive platform for configuring managing XBee devices behind the gateway. The **XBee Networks** view displays nodes in the context of their XBee network, including their node ID, the network to which they belong, physical addresses, their role in the XBee network (coordinator, router, or end node), their defined parent in the network, and their current status.

This view has a Search function that allows you to search for any device in the network associated with any gateway, a convenient function when managing multiple XBee networks with many nodes.

| Network Gateway | Node Address | Node ID | Module Type | Product Type | Type | Role | Network Address |
|-------------------|-------------------------|---------|-------------|--------------|---------|------|-----------------|
| 00409dFF-FF3387E0 | 00 13 a2 00 40 0a 38 0a | --- | XBee ZB | X8 Gateway | 0x30001 | --- | 0x0 |
| 00409dFF-FF3C1E0F | 00 13 a2 00 40 0a 53 75 | --- | XBee ZB | X4 Gateway | 0x30002 | --- | 0x0 |

Node View

From the **XBee Network** view, click **Basic**, **Advanced**, or **Summary** to view details about nodes. The **Basic** view shows the basic configuration settings for a node.

The screenshot shows the 'Basic' configuration view for a node. The left sidebar has 'Basic' selected. The main area displays the following settings:

| Parameter | Value | Unit |
|-------------------------|----------------|------------|
| Node identifier: | Brad's Gateway | |
| Node discovery timeout: | 60 | x 100 msec |
| Scan channels: | 0x1ffe | |
| Scan duration: | 3 | exponent |
| Transmit power level: | 4 | |
| Node join time: | 255 | sec |
| Broadcast radius: | 0 | |

The **Advanced** view shows more detailed configuration settings for a node.

The screenshot shows the 'Advanced' configuration view for a node. The left sidebar has 'Advanced' selected. The main area displays the following settings:

| Parameter | Value | Unit |
|---------------------------------|---------------------|-----------|
| Aggregation route notification: | 255 | x 10 sec |
| Encryption enable: | 0 | |
| Encryption options: | 0x0 | |
| Extended PAN identifier: | 0x00000000000000a43 | |
| Initial PAN identifier: | 0xffff | |
| Join notification: | 0 | |
| Join verification: | 0 | |
| Link encryption key: | | |
| Maximum hops: | 30 | |
| Network encryption key: | | |
| Network watchdog timeout: | 0 | min |
| Power mode: | 1 | |
| Peripheral sleep count: | 1 | |
| Cyclic sleep period: | 500 | x 10 msec |
| ZigBee stack profile: | 0 | |

The **Summary** view displays running-state and status information for a node.

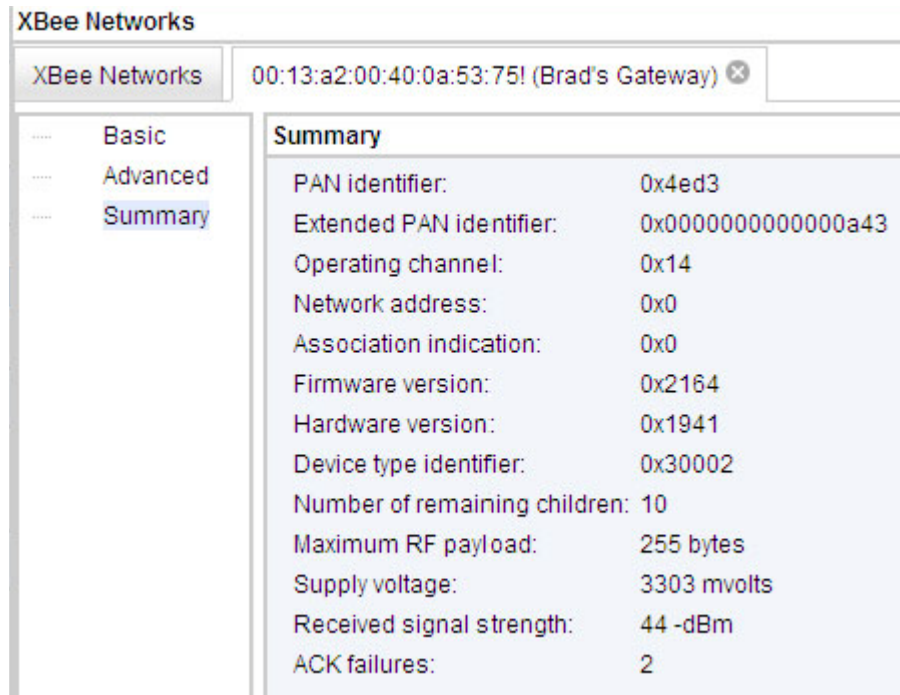

The screenshot shows the 'XBee Networks' interface. At the top, there is a tab labeled 'XBee Networks' and a dropdown menu showing the selected network: '00:13:a2:00:40:0a:53:75! (Brad's Gateway)'. Below this, there are three tabs: 'Basic', 'Advanced', and 'Summary'. The 'Summary' tab is selected, displaying a list of network parameters and their values.

| Summary | |
|-------------------------------|---------------------|
| PAN identifier: | 0x4ed3 |
| Extended PAN identifier: | 0x00000000000000a43 |
| Operating channel: | 0x14 |
| Network address: | 0x0 |
| Association indication: | 0x0 |
| Firmware version: | 0x2164 |
| Hardware version: | 0x1941 |
| Device type identifier: | 0x30002 |
| Number of remaining children: | 10 |
| Maximum RF payload: | 255 bytes |
| Supply voltage: | 3303 mvolts |
| Received signal strength: | 44 -dBm |
| ACK failures: | 2 |

For more information on iDigi Platform

To learn more about the iDigi Platform and the services it provides, see the *iDigi Device Management and Web Services Tutorial*.

Configuration through the web interface

Open the web interface

To open the web interface, either enter the Digi device's URL in a web browser and log on to the device, if required, or use the Digi Device Discovery utility to locate it and open its web interface.

By entering the Digi device's IP address in a web browser

- 1 In the URL address bar of a web browser, enter the IP address of the device.
- 2 If security has not been enabled for the Digi device, the Home page of the web interface is displayed. If security has been enabled for the Digi device, a login dialog will be displayed. Enter the user name and password for the device. The default username is **root** and the default password is **dbps**. If these defaults do not work, contact the system administrator who set up the device. Then the Home page of the web interface is displayed. See "Organization of the web interface" on page 60 for an overview of using the Home page and other linked pages.

Note The idle timeout automatically logs users out of the web interface after 5 minutes of inactivity if password authentication has been enabled for the device.

By using the Digi Device Discovery utility

Alternatively, use the Digi Device Discovery Utility to locate the Digi device and open its web interface.

Install and run the Digi Device Discovery utility

The Digi Device Discovery Utility is available for downloading from the Digi Support site.

If this utility is not already available on your computer, follow these steps.

- 1 From a browser, go to **www.digi.com**.
- 2 Click the **Support** link and select **Diagnostics, Utilities and MIBs**.
- 3 Under **Select Your Product for Support**, select your Digi device from the product list and click **Submit**.
- 4 Under **Active Products**, select your Digi device from the product list.
- 5 Under **OS Specific Diagnostics, Utilities and MIBs**, select the operating system for your computer from the list.
- 6 Select either **Device Discovery Utility for Windows - Standalone version** or **Device Discovery Utility for Windows - Installable version**. The standalone version runs the utility immediately after the download is complete. The installable version installs the utility on your computer and adds it to a program group named Digi in the Start menu.
- 7 Click **Run** on the two dialogs. The standalone version of the utility starts immediately. For the installable version, an installation wizard is displayed. Follow the prompts to complete the installation. To start the utility, select **Start > Programs > Digi > Digi Device Discovery > Digi Device Discovery**

Discover devices

From the start menu, select **Start > Programs > Digi Connect > Digi Device Discovery**. The Digi Device Discovery application is displayed.

Locate the device in the list of devices, and double-click it, or select the Digi device from the list and select **Open web interface** in the **Device Tasks** list.

| IP Address | MAC Address | Name | Device |
|--------------|-------------------|----------|--------------------------|
| 10.8.16.10 | 00:04:F3:01:D8:CF | | ConnectPort X5 R ZB GPRS |
| 10.8.16.14 | 00:40:9D:3C:1E:0F | | ConnectPort X4 |
| 10.8.16.35 | 00:40:9D:23:87:8B | | PortServer TS 16 |
| 10.8.16.40 | 00:40:9D:3C:52:EC | | ConnectPort X2 |
| 10.8.16.46 | 00:40:9D:29:78:E6 | TravisX8 | ConnectPort X8 |
| 10.8.16.55 | 00:40:9D:29:8D:33 | | Digi Connect ES 8 SB |
| 10.8.16.57 | 00:40:9D:3B:98:AC | | ConnectPort X2 |
| 10.8.16.65 | 00:04:F3:01:F9:A2 | | ConnectPort X5 F ZB GPRS |
| 10.8.16.66 | 00:40:9D:3B:98:AF | | ConnectPort X2 |
| 10.8.16.67 | 00:40:9D:32:E1:F7 | | ConnectPort X8 |
| 10.8.16.76 | 00:40:9D:3B:98:B2 | | ConnectPort X2 |
| 10.8.16.80 | 00:40:9D:27:33:63 | | Digi Connect ME |
| 10.8.110.32 | 00:04:F3:01:D8:C3 | | ConnectPort X5 F ZB GPRS |
| 10.8.110.33 | 00:04:F3:01:D8:BB | | ConnectPort X5 R ZB GPRS |
| 10.8.115.11 | 00:40:9D:29:8D:4A | | ConnectPort X4 NEMA |
| 10.8.115.242 | 00:40:9D:28:55:02 | | PortServer TS 16 Rack |
| 10.8.117.8 | 00:40:9D:23:25:A7 | | PortServer TS 2 H |
| 10.8.127.34 | 00:40:9D:23:00:5C | | PortServer TS 4 MEI |
| 10.8.128.5 | 00:40:9D:28:ED:AD | | PortServer TS 16 Rack |

19 devices | My Device Network

Organization of the web interface

When the web interface is opened, the Home page is displayed.

Here is a home page for a ConnectPort X Family product.



ConnectPort X4 Configuration and Management

[Home](#)

Configuration

- [Network](#)
- [Mobile](#)
- [XBee Network](#)
- [Serial Ports](#)
- [Camera](#)
- [Alarms](#)
- [System](#)
- [Remote Management](#)
- [Security](#)
- [Position](#)

Applications

- [Python](#)
- [RealPort](#)
- [Industrial Automation](#)

Management

- [Serial Ports](#)
- [Connections](#)
- [Event Logging](#)
- [Network Services](#)

Administration

- [File Management](#)
- [X.509 Certificate/Key Management](#)
- [Backup/Restore](#)
- [Update Firmware](#)
- [Factory Default Settings](#)
- [System Information](#)
- [Reboot](#)

[Logout](#)

Home

[Getting Started](#)

Tutorial Not sure what to do next? This Tutorial can help.

System Summary

| | | |
|-----------------------|--------------|-------------------------------------|
| | Model: | ConnectPort X4 |
| Ethernet MAC Address: | | 00:40:9D:33:94:11 |
| Ethernet IP Address: | | 10.8.16.50 |
| Mobile IP Address: | | Not Connected |
| | Description: | DAQ Demo Test System |
| | Contact: | BradC |
| | Location: | Minnetrissa |
| | Device ID: | 00000000-00000000-00409DFF-FF339411 |

The Home page

The left side of the Home page has a menu of choices that display pages for configuration, management, and administration tasks, and to log out of the web interface. This chapter focuses on the choices under **Configuration** and **Applications**. For details on monitoring Digi devices and the choices under **Management**, see Chapter 4, "Monitor and manage Digi devices". For details on the tasks under **Administration**, see Chapter 5, "Digi device administration".

Clicking **Logout** logs out of a configuration and management session with a Digi device. It does not close the browser window, but displays a logout window. To finish logging out of the web interface and prevent access by other users, close the browser window. Or, log back on to the device by clicking the link on the screen. After 5 minutes of inactivity, the idle timeout also automatically performs a user logout.

The **Getting Started** section has a link to a tutorial on configuring and managing Digi device.

The **System Summary** section notes all available device-description information.

Configuration pages

The choices under **Configuration** in the menu display pages for configuring settings for various features, such as network settings, and serial port settings. Some of the configuration settings are organized on sets of linked screens. For example, the Network Configuration screen initially displays the IP Settings, and provides links to Network Services Settings, Advanced Settings, and other network settings appropriate to the Digi device.

Applications pages

Depending on the Digi device, there may be an **Applications** menu item for configuring various applications available for use in the device.

- **Python:** For loading and running custom programs authored in the Python programming language onto ConnectPort X Family devices.
- **Ekahau Client:** For Digi Connect wireless devices, configures Ekahau Client™ device-location software. See page 175.
- **RealPort:** Configures RealPort settings. See page 173.
- **Industrial Automation:** Configures the Digi device for use in industrial automation applications.

Apply and save changes

The web interface runs locally on the device, which means that the interface always maintains and displays the latest settings in the Digi device. On each screen, the **Apply** button is used to save any changes to the configuration settings to the Digi device.

Cancel changes

To cancel changes to configuration settings, click the **Refresh** or **Reload** button on the web browser. This causes the browser to reload the page. Any changes made since the last time the **Apply** button was clicked are reset to their original values.

Restore the Digi device to factory defaults

The device configuration can be reset to factory defaults as needed during the configuration process. See "Restore a device configuration to factory defaults" on page 217.

Online help

Online help is available for all screens of the web interface, and for common configuration and administration tasks. There is also tutorial available on the Home page.

Change the IP address from the web interface, as needed

Normally, IP addresses are assigned to Digi devices either through DHCP or the Digi Device Setup Wizard.

This procedure assumes that the Digi device already has an IP address and you simply want to change it.

- 1 Open a web browser and enter the Digi device's current IP address in the URL address bar.
- 2 If security is enabled for the Digi device, a login prompt is displayed. Enter the user name and password for the device. The default username is **root** and the default password is **dbps**. If these defaults do not work, contact the system administrator who set up the device.
- 3 Click **Network** to access the Network Configuration page.
- 4 On the IP Settings page, select **Use the following IP address**.
- 5 Enter an IP address (and other network settings), then click **Apply** to save the configuration.

Network configuration settings

The Network configuration pages include:

- **Ethernet IP settings:** For viewing IP address settings and changing as needed. See page 66.
- **WiFi IP settings:** For setting the IP address used for wireless LAN communication. See page 66.
- **WiFi LAN settings:** For setting basic options for wireless LAN devices such as network name and network connection options. See page 67.
- **WiFi Security settings:** For setting authentication and encryption options for wireless LAN devices. See page 68.
- **WiFi 802.1x Authentication settings:** Detailed authentication settings for IEEE 802.1x authentication for wireless LAN devices. See page 70.
- **DHCP Server settings:** For configuring a DHCP server to allow other devices or hosts on this network to be assigned dynamic IP addresses. See page 71.
- **Network Services settings:** Enable and disables access to various network services, such as ADDP, RealPort and Encrypted RealPort, Telnet, HTTP/HTTPS, and other services. See page 75.
- **Dynamic DNS Update settings:** For configuring a Dynamic DNS (DDNS) service that allows a user whose IP address is dynamically assigned to be located by a host or domain name. See page 78.
- **IP Filtering settings:** For configuring the Digi Cellular Family device to only accept connections from specific and known IP addresses or networks. See page 81.
- **IP Forwarding settings:** For configuring the Digi Cellular Family device to forward certain connections to other devices. This is also known as Network Address Translation (NAT) or Port Forwarding. See page 82.
- **IP Network Failover settings:** provides a dynamic method for selecting and configuring the default gateway for the Digi device using a set of rules and link tests to determine whether a particular network interface can be used to communicate with a specified destination. See page 85.
- **Socket Tunnel settings:** For configuring a socket tunnel, used to connect two network devices: one on the Digi Cellular Family device's local network and the other on the remote network. See page 89.
- **Virtual Private Network (VPN) settings:** For configuring Virtual Private Networks, which are used to securely connect two private networks together so that devices may connect from one network to the other network using secure channels. See page 90.

- **IP Pass-through settings:** Configures a Digi Cellular Family device to pass its mobile IP address directly through and to the Ethernet device (router or PC) to which it is connected through the Ethernet port. The Digi Cellular Family device becomes transparent (similar to the behavior of a cable or DSL modem) to provide a bridge from the mobile network directly to the end device attached to the Digi Cellular Family device. See page 90.
- **Host List settings:** Adds or removes entries from the host list. For DialServ, the host list provides a means to map a phone number (in the local name field) to a network destination, (in the “resolves_to” field). See page 101.
- **Virtual Router Redundancy Protocol (VRRP) settings:** For configuring a number of routers to represent a virtual router, which simplifies configuration of hosts on a network.
- **Advanced Network Settings:** Configures the Ethernet Interface speed and mode, TCP/IP settings, TCP keepalive settings, and DHCP settings. See page 103.

Alternatives for configuring network communications

There are three ways a Digi device can be configured on the network.

- **Using dynamic settings:** All network settings will be assigned automatically by the network, using a protocol called DHCP. Contact your network administrator to find out if a DHCP server is available.
- **Using static settings:** All network settings are set manually and will not change. The IP address and subnet mask are mandatory. The rest are not mandatory, but may be needed for some functions. Contact your network administrator for the required values.
- **Using Auto-IP:** Auto-IP assigns an IP address to the Digi device immediately after it is plugged in. If running DHCP or ADDP, the Auto-IP address is overridden and a network compatible IP address is assigned, or a static IP address can be assigned.

ConnectPort X Family products have two IP addresses: one for Ethernet and one for cellular. All ConnectPort X Family products have a pre-defined default Ethernet Port IP address of **192.168.1.1**.

Even if a DHCP server is available, the device configuration may work better with static settings. Once set, static settings will not change, so you and other network devices can always find the Digi device by its IP address. With dynamic settings, the DHCP server can change the IP address. This can happen frequently or infrequently depending on how your network administrator has configured the network.

When the IP address does change, you and other network devices configured to talk to the Digi device can no longer access the device. In this case, the Digi device must be located the Digi Device Discovery utility, and other network devices that need to communicate with the Digi device must be reconfigured.

Ethernet IP settings

The Ethernet IP Settings page configure how the IP address of the Digi device is obtained, either by DHCP or by using a static IP address, subnet mask, and default gateway. For more information about how these settings are assigned and used in your organization, contact your network administrator.

- **Obtain an IP address automatically using DHCP:** When the Digi device is rebooted, it will obtain new network settings. Use the Digi Device Setup Wizard to find the Digi device, since it will likely have a new address.
- **Use the following IP Address:** Choose this option to supply static settings. An IP address and Subnet mask must be entered. Other items are not mandatory, but may be needed for some functions (such as talking to other networks).
- **IP Address:** An IP address is like a telephone number for a computer. Other network devices talk to this Digi device using this ID.

The IP address is a 4-part ID assigned to network devices. IP addresses are in the form of 192.168.2.2, where each number is between 0 and 255.

- **Subnet Mask:** The Subnet Mask is combined with the IP address to determine which network this Digi device is part of. A common subnet mask is 255.255.255.0.
- **Default Gateway:** IP address of the computer that enables this Digi device to access other networks, such as the Internet.
- **Enable Auto assignment:** With AutoIP enabled, the Digi device will automatically self-configure an IP address when an address is not available from other methods, for example, when the Digi device is configured for DHCP and a DHCP server is not currently available.

WiFi IP settings

The WiFi IP settings configure how the IP address of a Wi-Fi-enabled Digi device is obtained. It has the same settings as the Ethernet IP settings page.

WiFi LAN settings

Digi devices with Wi-Fi (wireless LAN) capability contain a wireless network interface that may be used to communicate to wireless networks using 802.11b8 technology. Contact your administrator or consult wireless access point documentation for the settings required to setup the wireless LAN configuration. Settings include:

- **Network name:** The name of the wireless network to which the wireless device should connect. In situations with multiple wireless networks, this setting allows the device to connect to and associate with a specific network. The network name is referred to as the SSID (service set identifier). If the network name is left blank, the device will search for wireless networks and connect to the first available network. This is useful if a specific network name does not need to be used as the device will select the first available network.
- **Connection method:** The type of connection method this device uses to communicate on wireless networks. Choose from:
 - **Connect to any available wireless network:** Use this setting to allow the device to access any network. The device can either access point networks or peer-to-peer wireless networks.
 - **Connect to access point (infrastructure) networks only:** Use this setting if the wireless network that this device needs to connect to is composed of wireless access points. This is typically the most popular method for connecting to wireless networks.
 - **Connect to peer-to-peer (ad-hoc) networks only:** Use this setting if all devices on the wireless network connect to and communicate with each other. This is known as peer-to-peer in that there is no central server or access point. Each system communicates directly with each other system.
- **Country:** The country in which this wireless device is being used. The channel settings are restricted to the legal set for the selected country.
- **Channel:** The frequency channel that the wireless radio will use. Select Auto-Scan to have the device scan all frequencies until it finds one with an available access point or wireless network it can join.
- **Transmit Power:** The transmit power level in dBm.
- **Enable Short Preamble:** Enables transmission of wireless frames using short preambles. If Short Preamble is supported in the wireless network, enabling it can boost overall throughput.

WiFi security settings

The WiFi security settings specify the wireless security settings that the wireless network uses. Multiple security and authentication modes may be chosen depending on the configuration of the access point or wireless network. The wireless device will automatically select and determine the authentication and encryption methods to use while associating to the wireless network. If the wireless network does not use security and uses an *Open Network* architecture, these settings do not need to be modified.

Note that WPA settings require that the device communicate to Access Points and is not valid when the **Connection Method** is set to **Connect to wireless systems using peer-to-peer (ad-hoc)**. Also, WPA pre-shared key (WPA-PSK) security is only valid when a specific **Network Name** or SSID is being used.

- **Network Authentication:** The authentication method or methods used for wireless communications.
 - **Use any available authentication method:** Enables all of the methods. The actual method used will be determined by the capabilities of the wireless network.
 - **Use the following selected method(s):** Selects one or more authentication methods for wireless communications.

Open System: IEEE 802.11 open system authentication is used to establish a connection.

Shared Key: IEEE 802.11 shared key authentication is used to establish a connection. At least one WEP key must be specified in order to use shared key authentication.

WEP with 802.1x authentication: IEEE 802.1x authentication (EAP) is used to establish a connection with an authentication server or access point. Wired Equivalent Privacy (WEP) keys are dynamically generated to encrypt data over the wireless network.

WPA with pre-shared key (WPA-PSK): The Wi-Fi Protected Access (WPA) protocol is used with a pre-shared key (PSK). The PSK is calculated using a passphrase and the network SSID.

WPA with 802.1x authentication: The WPA protocol and IEEE 802.1x authentication (EAP) is used to establish a connection with an authentication server or access point. Encryption keys are dynamically generated to encrypt data over the wireless link.

Cisco LEAP: Lightweight Extensible Authentication Protocol (LEAP) is used to establish a connection with an authentication server or access point. Wired Equivalent Privacy (WEP) keys are dynamically generated to encrypt data over the wireless link. A user name and password must be specified to use LEAP.

- **Data Encryption:** Multiple encryption methods can be selected.
 - **Use any available encryption method:** enables all of the methods. The actual method used will be determined by the capabilities of the wireless network.
 - **Use the following selected method(s):** Selects one or more encryption methods.

Open System: No encryption is used over the wireless link. Open System encryption is valid only with Open System and Shared Key authentication.

WEP: Wired Equivalent Privacy (WEP) encryption is used over the wireless link. WEP encryption can be used with any of the above authentication methods.

TKIP: Temporal Key Integrity Protocol (TKIP) encryption is used over the wireless link. TKIP encryption can be used with WPA-PSK and WPA with 802.1x authentication.

CCMP: CCMP (AES) encryption is used over the wireless link. CCMP can be used WPA-PSK and WPA with 802.1x authentication.
- **WEP Keys**
 - **Transmit Key:** Specify the corresponding key of the encryption key that should be used when communicating with wireless networks using WEP security.

This device allows up to four wireless keys to be set of either 64-bit or 128-bit encryption. These keys allow the wireless network to traverse different wireless networks without having to change the wireless key. Instead, only the transmit key setting has to be changed to specify which wireless key to send.
 - **Encryption Keys:** Specify 1 to 4 encryption keys to be used when communicating with wireless networks using WEP security.

The encryption keys should be a set of 10 (64-bit) or 26 (128-bit) hexadecimal characters. The encryption key should only contain the characters A-F, a-f, or 0-9. Optionally, separator characters, such as '-', '_', or '.' may be used to separate the set of characters.
- **WPA PSK (Pre-Shared Key) Passphrase/Confirm:** The passphrase that the Wi-Fi network uses with WPA pre-shared keys. The pre-shared key is calculated using the passphrase and the SSID. Therefore, a valid network name must have been previously specified. In the **Confirm** field, reenter the passphrase.
- **Username/Password/Confirm:** The username and password combination used to authenticate on the network when using these authentication methods: WEP with 802.1x authentication, WPA with 802.1x authentication, or LEAP. In the **Confirm** field, reenter the password.

WiFi 802.1x authentication settings

These settings are not required based on the current Wi-Fi authentication settings. They are only configurable when **WEP with 802.1x authentication** or **WPA with 802.1x authentication** are enabled on the WiFi Security Settings tab.

- **EAP Methods:** These are the types of Extensible Authentication Protocols (EAP) or outer protocols that are allowed to establish the initial connection with an authentication server or access point. These are used with WEP with 802.1x authentication and WPA with 802.1x authentication.
 - **PEAP:** Stands for “Protected Extensible Authentication Protocol.” A username and password must be specified to use PEAP.
 - **TLS:** Stands for “Transport Layer Security.” A client certificate and private key must be installed in order to use TLS.
 - **TTLS:** Stands for “Tunneled Transport Layer Security.” A username and password must be specified to use TTLS.
- **PEAP/TTLS Tunneled Authentication Protocols:** These are the types of inner protocols that can be used within the encrypted connection established by PEAP or TTLS.

These **Extensible Authentication Protocols (EAP)** can be used with PEAP or TTLS.

- **GTC:** Generic Token Card
- **MD5:** Message Digest Algorithm.
- **MSCHAPv2:** Microsoft Challenge response Protocol version 2.
- **OTP:** One Time Password

These **non-EAP protocols** that can be used with TTLS.

- **CHAP:** Challenge Response Protocol
- **MSCHAP:** Microsoft Challenge response Protocol
- **TTLS MSCHAPv2:** TTLS Microsoft Challenge response Protocol version 2.
- **PAP:** Password Authentication Protocol

- **Client Certificate Use:** When the TLS is protocol is enabled, a client certificate and private key must be installed on the Digi device.
 - **Certificate:** Click **Browse** to select a client certificate file. Then click the next **Browse** to select a private key file.
 - **Private Key File:** If the private key file is encrypted, a password must be specified.
- **Trusted Certificates:** Adds and lists trusted certificates.
 - **Verify server certificates:** Enable to verify that certificates received from an authentication server or access point are signed by a trusted certificate authority (CA). Standard CAs are built in. Additional trusted certificates may be added.
 - **Trusted Certificate File:** To add additional trusted certificates, click **Browse** to select a certificate file to upload to the Digi device, then click **Upload**.
- **Installed Certificates:** Shows which client certificates have been added and are in use.

DHCP server settings

The DHCP server feature can be enabled in a Digi device to allow other devices or hosts on this network to be assigned dynamic IP addresses. This DHCP server supports a single subnetwork scope.

For the DHCP server to operate, the Digi device must be configured to use a static IP address. For information on how to configure static IP settings, see "Ethernet IP settings" on page 66.

DHCP terminology

Some key DHCP terms involved in configuring a DHCP server include:

scope

A scope is the full consecutive range of possible IP addresses for a network. A scope typically defines a single physical subnet on your network, to which DHCP services are offered. A scope is the primary way for the DHCP server to manage distribution and assignment of IP addresses and related configuration parameters to its clients on the network.

exclusion range

An exclusion range is a limited sequence of IP addresses within a scope, excluded from DHCP service offerings. Exclusion ranges assure that any addresses in these ranges are not offered by the server to DHCP clients on your network.

address pool

After the scope is defined and exclusion ranges are applied, the remaining addresses form the available address pool within the scope. The addresses in this pool are available for dynamic assignment by the server to DHCP clients on your network.

lease

A lease is the length of time that the DHCP server specifies, during which a client host can use an assigned IP address. When the DHCP server grants a lease to a client, the lease is active. Before the lease expires, the client typically needs to renew its address lease assignment with the DHCP server. A lease becomes inactive when it expires or it is deleted at the server, or if the client actively releases the lease. The duration of a lease determines when it will expire and how often the client needs to renew it with the DHCP server in order to retain the lease.

A DHCP server will never grant a lease to its own address. There is no need for its own address to be in the exclusion range; the DHCP server simply protects its address from being offered.

grace period

When a DHCP client actively releases a lease, or when the lease expires without being renewed by the client, the DHCP server does not immediately delete the lease record and return the associated IP address to the available address pool. A grace period is the interval of time for which the lease record is retained before the DHCP server automatically deletes the record from its lease list, thereby making the IP address available for lease assignment to another client. The grace period is not a configurable value. See also the discussion of the grace period and what it means when the DHCP server is running in "View and manage current DHCP leases" on page 203.

reservation

You may use a reservation to create a permanent address lease assignment by the DHCP server. Reservations assure that a specified hardware device on the subnet can always use the same IP address. Address lease reservations associate a specific IP address with a specific client's Ethernet MAC address.

options

Options are other client configuration parameters that the DHCP server can assign when serving leases to DHCP clients. Most options are defined in RFC 2132. The DHCP server in the Digi device supports a limited set of options:

- Option 3: Routers on Subnet
- Option 6: DNS Servers

Addresses in the DHCP server settings

The IP address and subnet mask of the DHCP server's scope are the static IP configuration settings for the Digi device itself.

The default gateway (router) provided to a client with the lease information is the IP address of the Digi device.

The DNS servers provided to a client with the lease information are the DNS server addresses configured in the Digi device. These addresses include any DNS server addresses that the Digi device acquires when it connects to the mobile network.

DHCP server configuration settings

Here are the configuration settings for the DHCP server. Typically, these settings can be modified without having to restart the DHCP server for the changes to become effective in the running server.

- **Enable Dynamic Host Configuration Protocol (DHCP) Server:** Enables the DHCP server feature on this Digi device. Note that for the DHCP server to operate, the Digi device must be configured to use a static IP address. For information on how to configure static IP settings, see "Ethernet IP settings" on page 66.
 - **Scope Name:** The name of the physical network interface associated with the subnet being served by the DHCP Server. Most Digi device models have a single network interface, so there is no choice for the scope name. For models that have multiple network interfaces, such as an Ethernet interface and a Wi-Fi (802.11) interface, this DHCP Server may be configured to provide services on either of those interfaces.
 - **IP Addresses:** The starting and ending IP addresses for the scope being served by this DHCP server. These addresses must be in the same subnet as the Digi device itself.
 - **Lease Duration:** The length of the leases for the scope being served by this DHCP server. The default lease duration is 24 hours. A DHCP client may request a lease duration other than this setting, and the DHCP server will grant that request if possible.
- **Wait specified delay before sending DHCP offer reply:** The interval of time in milliseconds to delay before offering a lease to a new client. The default delay is 500ms, and the range is 0 to 5000ms. Use of this delay permits this Digi device to reside on a network with other DHCP servers, yet not offer leases to new clients unless the other DHCP servers do not make such an offer. This provides a measure of protection against inadvertently connecting a Digi device to a network that is running its own DHCP server(s), and offering leases to clients in a manner inconsistent with that network.
- **Check that an IP address is not in use before offering it:** When a DHCP client requests a new IP address lease, before offering an IP address to that client, use "ping" to test whether that IP address is already in use by another host on the network but is unknown to the DHCP server. If an IP address is determined to be in use, it is marked as **Unavailable** for a period of time, and it will not be offered to any client while in this state. Enabling this test adds approximately one second of delay before the IP address is offered to the client, since the "ping" test must not receive a valid reply for that test to successfully determine that the IP address is not already in use. This option is off (disabled) by default. This option does not apply to Static Lease Reservations, since the "ping" test is not used for them.

- **Send the DHCP Server IP address as a DNS Proxy Server:** This option configures the DHCP Server to send its IP address to a DHCP client as the first DNS server in its lease information. This Digi device supports a DNS Proxy feature that will relay DNS requests and responses between DNS clients and servers. The DNS Proxy is not a feature of the DHCP Server itself, but rather it is managed elsewhere in the configuration settings for this Digi device. For DNS Proxy to be used effectively by a DHCP client, it must be enabled both in the DHCP server configuration and in the DNS Proxy settings. For more information, see the description of the Enable DNS Proxy Service setting in "Advanced network settings" on page 103. This option is on (enabled) by default.

 - **Static Lease Reservations:** A static lease reservation is a specific IP address paired with a client's MAC address, which reserves the IP address for that client's use only. This assures that a client always receives a lease for the same IP address and that no other client obtains a lease for that address.

To add a reservation, enter the IP address and MAC Address values, check or clear the **Enable** checkbox, and then press the **Add** button.

After adding a reservation, you may click on the IP address or MAC address of that entry in the table, permitting you to specify or modify the lease duration for this reservation.

The **Enable** checkbox for the entry permits a reservation to be disabled without actually removing the entry, then enabled again at a later time.

The **Remove** link is used to permanently remove a reservation from the DHCP server configuration.

The **Remove All** link is used to permanently remove all reservations from the DHCP server configuration.

 - **Address Exclusions:** A specific set of IP addresses to exclude from the scope. The DHCP server will not grant leases to clients for any IP address in the exclusion range.
- To add an exclusion, enter the starting and ending IP addresses, check or clear the **Enable** checkbox, and then press the **Add** button.
- The **Enable** checkbox for the entry permits an exclusion to be disabled without actually removing the entry, then enabled again at a later time.
- The **Remove** link is used to permanently remove an exclusion from the DHCP server configuration.
- The **Remove All** link is used to permanently remove all exclusions from the DHCP server configuration.
- **Apply button:** You **must** click the **Apply** button to save changes you make to the DHCP server settings. If you leave this page without applying the changes, those changes will be discarded.

Manage the DHCP server

To manage the DHCP server and view/manage lease status, go to **Management > Network Services**. See "Manage DHCP server operation" on page 203.

Network services settings

The Network Services page shows a set of common network services that are available for Digi devices, and the network port on which the service is running.

Common network services can be enabled and disabled, and the TCP port on which the network service listens can be configured. Disabling services may be done for security purposes. That is, certain services can be disabled so the device runs only those services specifically needed. To improve device security, non-secure services such as Telnet can be disabled.

It is usually best to use the default network port numbers for these services because they are well known by most applications.

Several services have a setting for whether TCP keep-alives will be sent for the network services. TCP keep-alives can be configured in more detail on the **Advanced Network Settings** page.



Caution Exercise caution in enabling and disabling network services, particularly disabling them. Changing certain settings can render a Digi Connect device inaccessible. For example, disabling Advanced Digi Discovery Protocol (ADDP) prevents the device from being discovered on a network, even if it is actually connected. Disabling HTTP and HTTPS disables access to the web interface. Disabling basic services such as Telnet, Rlogin, etc. can make the Command-Line interface inaccessible.

Supported network services and their default network port numbers

In Digi devices that have multiple serial ports, the network port number defaults for various services are set based on the following formula:

base network port number + serial port number

For example, the Telnet Passthrough service is set to network port 2001 for serial port 1, 2002 for serial port 2, 2003 for serial port 3, etc.

If a network port is changed for a particular service, that is the only network port number that changes. That change does not carry over to the other network ports. For example, if the network port number for Telnet Passthrough is changed from 2001 to 3001, that does not mean that the other network ports will change to 3002, 3003, etc.

There are two types of network services available:

- Basic services, which are accessed by connecting to a particular well-known network port.
- Passthrough services, in which a particular serial port is set up for a particular type of service. To use the service, users must both use the correct protocol and specify the correct network port. For example, assuming default service ports and using a Linux host, here is how a user would access the SSH and Telnet passthrough services:

```
#> ssh -l fred digi16 -p 2501
#> telnet digi16 2101
```

The table shows network services, services provided, and the default network port number for each service.

| Service | Services provided | Default network port number |
|---|--|-----------------------------|
| Device Discovery, also known as Advanced Digi Discovery Protocol (ADDP) | Discovery of Digi devices on a network. Disabling this service disables use of the Digi Device Discovery utility to locate the device, either on its own or as part of running the Digi Device Setup Wizard. The network port number for ADDP cannot be changed from its default. | 2362 |
| Encrypted (Secure) RealPort | Secure Ethernet connections between COM or TTY ports and device servers or terminal servers. | 1027 |
| RealPort | A virtual connection to serial devices, no matter where they reside on the network. | 771 |
| Line Printer Daemon (LPD) | Allows network printing over a serial port. | 515 |
| Modem Emulation Pool (pmodem) | Allows the Digi device to emulate a modem. Modem emulation sends and receives modem responses to the serial device over the Ethernet instead of Public Switched Telephone Network (PSTN). Telnet processing can be enabled or disabled on the incoming and outgoing modem-emulation connections. The pmodem service is for connecting to whatever serial port will answer. | 50001 |
| Modem Emulation Passthrough | Allows the Digi device to emulate a modem. This service is for dialing in to a particular serial port that has been set up for modem emulation. | 50001 |
| Remote login (Rlogin) | Allows users to log in to the Digi device and access the command-line interface through Rlogin. | 513 |
| Remote shell (Rsh) | Allows users to log in to the Digi device and access the command-line interface through Rsh. | 514 |
| Secure Shell Server (SSH) | Allows users secure access to log in to the Digi device and access the command-line interface. | 22 |
| Secure Shell (SSH) Passthrough | Accessing a specific serial port set up for SSH. | 2501 |
| Secure Socket Service | Authentication and encryption for Digi devices. | 2601 |
| Simple Network Management Protocol (SNMP) | Managing and monitoring the Digi device. To run SNMP in a more secure manner, note that SNMP allows for “sets” to be disabled. This securing is done in SNMP itself, not through this command. If disabled, SNMP services such as traps and device information are not used. | 161 |

| Service | Services provided | Default network port number |
|---|--|-----------------------------|
| Telnet Server | Allows users an interactive Telnet session to the Digi device's command-line interface. If disabled, users cannot Telnet to the device. | 23 |
| Telnet Passthrough | Allows a Telnet connection directly to the serial port, often referred to as reverse Telnet. | 2001 |
| Transmission Control Protocol (TCP) Echo | Used for testing the ability to send and receive over a TCP connection, similar to a ping. | 7 |
| Transmission Control Protocol (TCP) Passthrough | Allows a raw socket connection directly to the serial port, often referred to as reverse sockets. | 2101 |
| User Datagram Protocol (UDP) Echo | Used for testing the ability to send and receive over a UDP connection, similar to a ping. | 7 |
| User Datagram Protocol (UDP) Passthrough | Allows raw data to be passed between the serial port and UDP datagrams on the network. | 2101 |
| Web Server, also known as HyperText Transfer Protocol (HTTP) | Access to web pages for configuration that can be secured by requiring a user login. HTTP and HTTPS, below, are also referred to as Web Server or Secure Web Server. These services control the use of the web interface. If HTTP and HTTPS are disabled, device users cannot use the web interface to configure, monitor, and administer the device. | 80 |
| Secure Web Server, also known as HyperText Transfer Protocol over Secure Socket Layer (HTTPS) | Access to web pages for configuration that can be secured by requiring a user login, with encryption for greater security. | 443 |

Network services and IP pass-through

The IP pass-through feature (**Configuration > Network > IP Pass-through**) causes the Digi device to be bridged transparently between the Ethernet and mobile data links. Enabling IP Pass-through disables many device features, including many network services. To provide access to the device for configuration and management purposes, you can configure a subset of network services to terminate at the Digi device instead of being passed on to a connected device such as a router. In the IP pass-through feature, these network services are called *pinholes*. Services that can be configured as pinholes include HTTP, HTTPS, Telnet, SSH, and SNMP. See "IP pass-through settings" on page 98 for more information.

Dynamic DNS update settings

A Dynamic DNS (DDNS) service allows a user whose IP address is dynamically assigned to be located by a host or domain name. Before a DDNS service may be used, you must create an account with the DDNS service provider. The provider will give you account information such as username and password. You will use this account information to register your IP address and update it as it changes.

A DDNS service provider typically supports the registration of only public IP addresses. When using such a service provider, if your Digi device has a private IP address (such as 192.168.x.x or 10.x.x.x), your update requests will be rejected.

The Digi device monitors the IP address it is assigned. It will typically update the DDNS service or server automatically, but only when its IP address has changed from the IP address it previously registered with that service.

DDNS service providers may consider frequent updates to be an abuse of their service. In such a circumstance, the service provider may act by blocking updates from the abusive host for some period of time, or until the customer contacts the provider. Please observe the requirements of the DDNS service provider to ensure compliance with possible abuse guidelines.

The Dynamic DNS Update Settings page includes both settings and status information.

Settings

- **Current IP address:** The IP address of the Digi device:
- **Use the following dynamic DNS service:** Disables DDNS updates, or selects the DDNS service provider to use to register the IP address of this Digi device. When you select a specific DDNS service provider, you must also provide the related account information for that service provider.

To force an update request to be sent to a particular DDNS service.

- 1 Select the **None** radio button to disable DDNS updates, and then click **Apply** to save that change.
- 2 Select the radio button for the DDNS service you wish to update
- 3 Click **Apply** to save that change.

If the settings for the selected DDNS service are all specified and valid, an update request will be sent immediately to that service.

- **DynDNS.org DDNS Service:** You must create your account at DynDNS.org before you can successfully register the IP address of your Digi device with their service. Please familiarize yourself with their service options and requirements, in order to most effectively use this feature of your Digi device.

This DDNS service supports only public IP addresses. If you have a private IP address (such as 192.168.x.x or 10.x.x.x), your update requests will be rejected.

- **Host and Domain Name:** The fully qualified host and domain name you have registered with your service provider. An example is: myhost.dyndns.net.
- **DynDNS User Name:** The user name for the account you have created with your service provider.
- **DynDNS Password:** The password for the account you have created with your service provider.
- **DynDNS DDNS System:** The system for the account you have created with your service provider. DynDNS.org supports a number of different services, which vary by the system you select. The available choices are:
 - Dynamic DNS
 - Static DNS
 - Custom DNS
- **Use Wildcards:** Enables/disables wildcards for this host. The available choices for this option are:
 - Disable wildcards
 - Enable wildcards
 - No change to service setting

According to wildcard documentation at DynDNS.org: “The wildcard aliases *.yourhost.ourdomain.tld to the same address as yourhost.ourdomain.tld.”

Using this option in the settings for your Digi device has the same effect as selecting the wildcard option on the DynDNS.org website. To leave the wildcard option unchanged from the current selection on their web site, use the “no change” option in the device settings. Note that DynDNS.org support for this option may vary according to the DynDNS system you are registered to use.

- **Connection Method:** The connection method to try when connecting to your service provider to register your IP address. DynDNS.org supports three methods to connect. The available choices are:
 - Standard HTTP port 80
 - Alternate HTTP port 8245
 - Secure HTTPS port 443

Status and history information

The next settings show status and history information for the DDNS service.

- **Most Recent DDNS Service Update Status:** This section provides the status of the most recent attempt to update a DDNS service or server. The displayed information confirms the success of an update request, or it may offer information as to the reason an update request was rejected by the service or server.

A number of status items are shown. Some of them are specific to the DDNS service being updated. Such information will be helpful when trying to resolve update failures with the DDNS service provider.

 - **Service:** The name of the DDNS service provider or server being updated.
 - **Reported:** The IP address for your Digi device that is being registered with the DDNS service provider or server.
 - **Update Status:** A simple indication of success or failure for this last update request.
 - **Result Information:** A DDNS service-specific status message, helpful when consulting technical support.
 - **Raw Result Data:** DDNS service-specific update result data returned by the service provider, helpful when consulting technical support.
- **Last Logged Action or Result:** The last attempted, logged action or result for the DDNS feature, helpful for troubleshooting possible problems with DDNS updates. This information may help identify problems with settings, network connection failures, and other issues that prevent a DDNS update from being completed successfully. Successful results also are reported here.

IP filtering settings

You can better restrict your device on the network by only allowing certain devices or networks to connect. This is better known as IP Filtering or Access Control Lists (ACL). By enabling IP filtering, you are telling the device to only accept connections from specific and known IP addresses or networks. Devices can be filtered on a single IP address or can be restricted as a group of devices using a subnet mask that only allows specific networks to access to the device.

Caution It is important to plan and review your IP filtering settings before applying them. Incorrect settings can make the Digi device inaccessible from the network.

On the IP Filtering Settings page, enter the settings as follows:

- **Only allow access from the following devices and networks:** Enables IP filtering so that only the specified devices or networks are allowed to connect to and access the device. Note that if you enable this feature and the system from which you are connecting to the Digi device is not included in the list of allowed devices or networks, then you will instantly no longer be able to communicate or configure the device from this system.
 - **Automatically allow access from all devices on the local subnet:** Specifies that all systems and devices on the same local subnet or network of the device should be allowed to connect to the device.

Allow access from the following devices: A list of IP addresses of systems or devices that are allowed to connect to this device.

Allow access from the following networks: A list of networks based on an IP address and matching subnet mask that are allowed to connect to this device. This option allows grouping several devices that exist on a particular subnet or network to connect to the device without having to manually specify each individual IP address.

IP forwarding settings

When a Digi device acts as a router and communicates on both a private and public network with different interfaces, it is sometimes necessary to forward certain connections to other devices. This is also known as Network Address Translation (NAT) or Port Forwarding. When an incoming connection is made to the device on the private network, the IP port is searched for in the table of port forwarding entries. If the IP port is found, that connection is forwarded to another specific device on the public network.

Port Forwarding/NAT is useful when external devices can not communicate directly to devices on the public network of the Digi device. For example, this may occur because the device is behind a firewall. By using port forwarding, the connections can pass through the networks transparently. Also, Port Forwarding/NAT allows multiple devices on the private network to communicate to devices on the public network by using a shared private IP address that is controlled by Port Forwarding/NAT.

Port forwarding can be used to connect from a Digi device to a RealPort device. For this type of connection to occur, your mobile wireless provider must be mobile-terminated.

IP Forwarding settings include:

- **Enable IP Routing:** Enables or disables IP forwarding.
- **Apply the following static routes to the IP routing table:** The Digi device can be configured with permanent static routes. These routes are added to the IP routing table when this device boots, or afterward when network interfaces become active or changes are made to this list of static routes. The use of static routes provides a means by which IP datagrams can be routed to a network that is not a local network or accessible through the default route.
- **Network Address Translation (NAT) Settings:** A list of instances of NAT settings is displayed. For each instance, the settings are:
 - **Enable Network Address Translation (NAT):** Permit the translation and routing of IP packets between private (internal) and public (external) networks. Refer to NAT configuration options below. Some Digi device models permit the configuration of NAT instances for more than one network interface. .
 - **NAT Public Interface:** The name of the network interface for which NAT will perform address and port translations. The list of interfaces available for NAT configuration varies according to the capabilities of your Digi device model.
 - **NAT Table Size Maximum:** The maximum number of entries that can be added to the NAT table. These entries include the configured port and protocol forwarding rules (see Forward TCP/UDP/FTP Connections and Forward Protocol Connections below), the DMZ Forwarding rule (see Enable DMZ Forwarding to this IP address below), as well as dynamic rules for connections that are created and removed during the normal operation of NAT. The NAT table size maximum value may be configured for any value in the range 64 through 1024, with the default value being 256 entries. Note that this setting does not control the maximum number of port or protocol forwarding rules that can be configured in their respective settings.

- **Enable DMZ Forwarding to this IP address:** DMZ Forwarding allows you to specify a single host (DMZ Server) on the private (internal) network that is available to anyone with access to the NAT Public Interface IP address, for any TCP- and UDP-based services that haven't been configured. Services enabled directly on the Digi device take precedence over (are not overridden by) DMZ Forwarding. Similarly, TCP and UDP port forwarding rules take precedence over DMZ Forwarding (please see **Forward TCP/UDP/FTP Connections** below). DMZ Forwarding is effectively a lowest priority default port forwarding rule that doesn't permit the same remapping of port numbers between the public and private networks, as is possible if you use explicit port forwarding rules.

If enabled, the DMZ Forwarding rule is used for incoming TCP and UDP packets from the public (external) network, for which there is no other rule. These other rules include explicit port forwarding rules or existing dynamic rules that were created for previous communications, be those outbound (private to public) or inbound (public to private). Also, the DMZ Forwarding rule is not used if there is a local port on the Digi device to which the packet may be delivered. This includes TCP service listener ports as well as UDP ports that are open for various services and clients. DMZ forwarding does not interfere with established TCP or UDP connections, either to local ports or through configured or dynamic NAT rules. Outbound communications (private to public) from the DMZ Server are handled in the same manner as the outbound communications from other hosts on that same private network. **S**



Security Warning: DMZ Forwarding presents security risks for the DMZ Server. Configure the DMZ Forwarding option only if you understand and are willing to accept the risks associated with providing open access to this server and your private network.

- **Forward protocol connections from external networks to the following internal devices:** Enables protocol forwarding to the specified internal devices. Currently, the only IP protocols for which protocol forwarding is supported are:
Generic Routing Encapsulation (GRE, IP protocol 47)
Encapsulating Security Payload (ESP, IP protocol 50, tunnel mode only).
These are routing protocols that are used to route (tunnel) various types of information between networks. If your network needs to use the GRE or ESP protocol between the public and private networks, enable this feature accordingly.

- **Forward TCP/UDP/FTP connections from external networks to the following internal devices:** Specifies a list of connections based on a specific IP port and where those connections should be forwarded to. Typically the connecting devices come from the public side of the network and are redirected to a device on the private side of the network.

It is possible to forward a single port or a range of ports. To forward a range of ports, specify the number of ports in the range, in the **Range Port Count** field for the port forwarding entry. When a range is configured, the first port in the range is specified, and the full range is indicated in the displayed entry information.

Note that FTP connections require special handling by NAT. This is because the FTP commands and replies are character-based, and some of them contain port numbers in this message text. Those embedded port numbers potentially need to be translated by NAT as messages pass between the private and public sides of the network. In consideration of these needs, one should select FTP as the protocol type when configuring a rule for FTP connection forwarding to an FTP server on the private network side. If TCP is used instead, FTP communications may not work correctly. Note also that TCP port 21 is the standard port number for FTP. Finally, the use of port ranges for FTP forwarding is not supported; a port count of 1 is required.

Example

For example, to enable port forwarding of RealPort data (network port 771) on a Digi Connect WAN VPN to a Digi Connect SP with an IP address of 10.8.128.10, you would do the following:

- Make sure the **Enable IP Routing** checkbox is checked.
- In the **Forward TCP/UDP connections from external networks to the following internal devices** section, enter the port forwarding information as follows, and click Add:

Forward TCP/UDP connections from external networks to the following internal devices:

| Enable | Protocol | Source Port | Destination IP Address | Destination Port | |
|-------------------------------------|----------|-------------|------------------------|------------------|-----|
| No connections have been added | | | | | |
| <input checked="" type="checkbox"/> | TCP | 771 | 10.8.109.9 | 771 | Add |

IP Network Failover settings

The IP Network Failover feature provides a dynamic method for selecting and configuring the default gateway for the Digi device. Failover uses a set of rules and link tests to determine whether a particular network interface can be used to communicate with a specified destination. The user configures these rules, link tests and the priority order of the interfaces.

Failover maintains a network interface list, ordered by the configured Failover Interface Priority, and containing information on the state of the network interface and recent success or failure of the link tests for that interface. The failover status for a network interface is one of the following:

- **1 - Responding:** The interface is Up and configured in the system. It is currently responding to the link tests. This interface is suitable for use as the default gateway.
- **2 - Up:** The interface is Up and configured in the system. Its status has not been determined by the link tests, or no link tests are configured. This interface may be suitable for use as the default gateway.
- **3 - Not Responding:** The interface is Up and configured in the system. However, it is not currently responding to the link tests, and the number of consecutive test failures has reached the threshold number configured in the Network Failover settings. This interface may be suitable for use as the default gateway.
- **4 - Down:** The interface is Down or not configured in the system. However, it is not currently responding to the link tests. This interface is not suitable for use as the default gateway.
- **5 - Unknown:** The interface is Unknown (does not exist) in the system. This interface is not suitable for use as the default gateway.

The number shown above for each status value, indicates the priority of that status, used by failover in selecting the interface to use as the default gateway. Status priority 1 is the most suitable for use, with lower priorities considered suitable if there are no interfaces at the highest priority.

When any network interface changes status, the interface list is examined for the interface that has the highest status priority, nearest the start of the list. The highest priority interface with a Responding status is used as the default gateway. If no interface is marked Responding then the highest Up interface is used, etc.

When Network Failover performs a link test, it adds a temporary static host route to the destination IP address for the link test, using the network interface that the link test is configured to test. The static host route is removed when the link test completes, whether successfully or in failure. Users should be careful to avoid manually configuring static host routes to any of the failover link test destinations, as such host routes may interfere with failover's link testing. Static IP routes are configured on the IP Forwarding Settings page. For additional information, see "IP forwarding settings" on page 82.

In the Advanced Network Settings, the Gateway Priority selection provides a simpler method for selecting the default gateway. However, if failover is properly configured and enabled, it overrides the Gateway Priority selection in the Advanced Network Settings. For a description of this non-failover Gateway Priority selection and information on how to configure it, see "Advanced network settings" on page 103.

For IP Network Failover status and statistics, see "IP Network Failover statistics" on page 193.

Network Failover General Settings

- **Enable IP Network Failover:** Enable the Network Failover feature in the Digi device. Click the checkbox to turn failover on or off.
- **Enable fallback to the non-failover default gateway priority method:** The fallback option is used if a default gateway cannot be configured by Network Failover. Failure to configure a default gateway could occur if one or more interfaces are not enabled (On) for Network Failover use, or if the enabled interfaces are not Up or do not have a gateway associated with them. Click the checkbox to turn fallback on or off.
- **Failover Interface Priority:** The list of available network interfaces in priority order, used by failover to determine the default gateway. The default gateway is used to route IP packets to an outside network, unless controlled by another route.

A network interface may have a static gateway configured for it, or it may obtain a gateway from DHCP or other means when the interface is configured. The first interface in this list that supplies a gateway will be used as the default gateway. The default gateway may change as interfaces connect and disconnect, and as failover link tests determine that an interface is providing the desired IP packet routing to a remote network destination.

To change the interface priority order, select an item from the list and click the up or down arrow.

- **Link Test Settings for each of the network interfaces:** The options that follow are used to configure the link tests for the network interfaces. Each network interface has its own set of options. Failover can support the use of Ethernet, Wi-Fi and Mobile (cellular) network interfaces. The available interfaces vary among different Digi products.
 - **Enable IP Network Failover for the XXX Interface:** Enable use of the XXX interface for failover, where XXX is Ethernet, Wi-Fi, or Mobile. Click the checkbox to turn failover on or off. If a network interface is not enabled for use by failover, it will not be considered by failover for use in selecting the default gateway.
 - **No Test:** Click on the radio button to select no link tests will be used for this interface. Since no link tests are run, failover will only be aware of the Up or Down status of the interface.
 - **Ping Test:** Click on the radio button to select the Ping Test as the link test to use for this interface. The Ping Test sends ICMP Echo Request packets to the configured destination IP address. If an ICMP Echo Reply is received (ping reply), the link test has successfully demonstrated that the network interface can be used to communicate with the specified destination.
 - Primary Destination (Ping Test):** The primary, or first, destination to ping. The destination must be a valid IPv4 address. If the destination is left empty, no Primary Destination link test will be attempted.
 - Secondary Destination (Ping Test):** The secondary, or second, destination to ping. The destination must be a valid IPv4 address. If the destination is left empty, no Secondary Destination link test will be attempted.
 - Send Count (Ping Test):** The maximum number of ping requests to send for a ping link test. When a reply is received, the ping test ends successfully and does not continue to send ping requests. If no ping reply is received after Send Count ping requests have been sent, the link test ends in failure.

Send Interval (Ping Test): The time interval in seconds between sending ping requests during a ping link test. The ping tests sends a ping request. If no ping reply is received before the Send Interval expires, another ping request is sent.

- **TCP Connection Test:** Click on the radio button to select the TCP Connection Test as the link test to use for this interface. The TCP Connection Test attempts to establish a TCP connection to the configured destination IP address and port number. If a connection is successfully established, or if the remote host actively rejects (resets) the connection attempt, the link test has successfully demonstrated that the network interface can be used to communicate with the specified destination. If a TCP connection is successfully established, it is immediately closed.

Primary TCP Port (TCP Connection Test): The destination TCP port to use to connect to the Primary Destination address.

Primary Destination (TCP Connection Test): The primary, or first, destination to which to establish a TCP connection. The Primary TCP Port is used as the port to which the test connects at the Primary Destination. The destination must be a valid IPv4 address. If the destination is left empty, no Primary Destination link test will be attempted.

Secondary TCP Port (TCP Connection Test): The destination TCP port to use to connect to the Secondary Destination address.

Secondary Destination (TCP Connection Test): The secondary, or second, destination to which to establish a TCP connection. The Secondary TCP Port is used as the port to which the test connects at the Secondary Destination. The destination must be a valid IPv4 address. If the destination is left empty, no Secondary Destination link test will be attempted.

Connection Timeout (TCP Connection Test): The time in seconds to wait for a TCP connection to be established or rejected by the destination host.

The following four Link Test options are used if the Ping or TCP Connection Link Test is selected.

- **Repeat the test every: N seconds:** The time interval (N) in seconds between the end of a successful link test and the start of the next link test for the network interface. This interval is used only after a successful test.

Shorter intervals verify the link more often, but they also increase the packet traffic over the network interface being tested. The frequency of tests should be considered carefully for network connections such as Mobile (cellular) connections, which may be expensive, depending on the service plan in effect with your mobile service provider.

- **On test failure, retry every: N seconds:** The time interval (N) in seconds between the end of a failed link test and the start of the next link test for the network interface. This interval is used after a failed test, but only until the “Not Responding” (consecutive failures) threshold has been reached.

A possible strategy is to configure a shorter Retry interval than the Success interval, to more quickly test the network connection to determine whether it is truly not working or there was just a transient test failure. Determining the validity of the link helps failover determine whether it is necessary to reconfigure the default gateway.

- **Report *Not Responding* after: N consecutive failures:** The threshold (N) in consecutive link test failures at which time the network interface is reported to failover as “Not Responding”. Upon receiving such a report, failover may determine that the default gateway should be reconfigured. The count of consecutive failures is reset to zero when a successful link test completes, or when the network interface is reconfigured or its connection is restarted (such as a mobile PPP connection).
- **When *Not Responding*, retry every: N seconds:** The time interval (N) in seconds between the end of a failed link test and the start of the next link test for the network interface. This interval is used after a failed test, but *only after* the “Not Responding” (consecutive failures) threshold has been reached.

Socket tunnel settings

A Socket Tunnel can be used to connect two network devices: one on the Digi device's local network and the other on the remote network. This is especially useful for providing SSL data protection when the local devices do not support the SSL protocol.

One of the endpoint devices is configured to initiate the socket tunnel. The tunnel is initiated when that device opens a TCP socket to the Digi device on the configured port number. The Digi device then opens a separate connection to the specified destination host. Once the tunnel is established, the Digi device acts as a proxy for the data between the remote network socket and the local network socket, regardless of which end initiated the tunnel.

Socket Tunnel settings include:

- **Enable:** Enables or disables the configured socket tunnel.
- **Timeout:** The timeout (specified in seconds) controls how long the tunnel will remain connected when there is no tunnel traffic. If the timeout value is zero, then no timeout is in effect and the tunnel will stay up until some other event causes it to close.
- **Initiating Host:** The hostname or IP address of the network device which will initiate the tunnel. This field is optional.
- **Initiating Port:** Specify the port number that the Digi device will use to listen for the initial tunnel connection.
- **Initiating Protocol:** The protocol used between the device that initiates the tunnel and the Digi device. Currently, TCP and SSL are the two supported protocols.
- **Destination Host:** The hostname or IP address of the destination network device.
- **Destination Port:** Specify the port number that the Digi device will use to make a connection to the destination device.
- **Destination Protocol:** This is the protocol used between Digi device and the destination device. Currently, TCP and SSL are the two supported protocols. This protocol does not need to be the same for both connections.
- Click the **Add** button to add a socket tunnel. Click the **Apply** button to save the settings. Once the socket tunnel is configured, check the **Enable** checkbox to enable the socket tunnel.

Virtual Private Network (VPN) settings

Virtual Private Networks (VPNs) are used to securely connect two private networks together so that devices may connect from one network to the other network using secure channels. VPN uses IP Security (IPSec) technology to protect the transferring of data over the Internet. All Digi Cellular Family products except Digi Connect WAN support VPNs.

The Digi device is responsible for handling the routing between networks. Devices within the local private network served by the Digi device can connect to devices on the remote network as if they are in the local network. The VPN tunnels are configured using various security settings and methods to ensure the networks are secured.

Uses for VPN-enabled Digi devices

VPN-enabled Digi devices, such as Digi Connect WAN VPN, are cellular-enabled routers that securely connect remote subnets using IPsec VPN technology. Devices in the Digi device's private network can connect directly to devices on the other private network with which the VPN tunnel is established. You configure VPN tunnels using security settings and methods to ensure the networks are secured.

The Digi device is used for primary or backup remote site connectivity. Secured IPsec VPN traffic is typically routed from the Digi device over the cellular IP network and is terminated by a VPN appliance at the host end.

A VPN-enabled Digi device can be used in several scenarios; for example:

- As the *primary* remote site router where no other WAN router is used.
- As a *backup* router where the remote site has a primary WAN connection through DSL, Frame Relay, or other means.
- To provide secure access to remote serial and/or Ethernet devices.

This section describes using a Digi device as a *primary* remote site router using IPsec Encapsulated Security Payload (ESP) and Internet Key Exchange (IKE)/Internet Security Association and Key Management Protocol (ISAKMP) pre-shared key methods.

VPN Global Settings

■ General Security Settings

- **Enable Antireplay:** Antireplay allows the IPsec tunnel receiver to detect and reject packets that have been replayed. Set this field to match that at the remote VPN gateway. The default is Enabled.

Important: Disable Antireplay if you use manual keyed tunnels.

■ Miscellaneous Settings

- **Suppress SA lifetime during IKE Phase 1:** In most cases, leave this option unchecked. Some VPN equipment does not negotiate the ISAKMP Phase 1 lifetimes. Such equipment may refuse to negotiate with the Digi device if it includes lifetime values in Phase 1 negotiation messages. If the Digi device must communicate with such equipment, enable this option to prevent the Phase 1 lifetimes from being included in the ISAKMP Phase 1 messages.
- **Suppress Delete Phase 1 SA Message For PFS:** In most cases this option should be unchecked. VPN devices usually send a delete notification for any phase 2 SAs that are left over from previous sessions when they start to negotiate quick mode. However, some devices do not handle this notification correctly and will terminate the connection when they receive it. If you have trouble connecting to the remote VPN device, you can try checking this box to suppress sending this message.
- **IP addresses of remote VPN peers may change on the fly (Dynamic DNS):** Check this box if you are specifying the address of the remote VPN device with a DNS name, and that device uses dynamic DNS because its public IP address can change. Checking this box will cause the Digi device to poll the DNS server once a minute to see if the remote VPN device's IP address has changed. The IPsec software will be restarted with the new IP address if it does change. Checking this option will increase network traffic since the unit will be polling the DNS server once a minute.

VPN tunnel configuration settings

- **Description:** Enter a short, one-line description of the VPN tunnel.
- **VPN Tunnel:** Displays settings for encryption and authentication keys. Selecting ISAKMP is recommended; it is the standard protocol used by almost all VPN devices. ISAKMP is more secure than manually setting the keys. The only time to set the keys manually is when connecting with an old VPN device that does not support ISAKMP, in which case you should replace the obsolete box with one that does.
- **Local Endpoint Type:**

Select **Local endpoint is a subnet** to allow devices on the remote network to see devices on the local network. This is the standard way IPsec works and the correct choice in most cases.

Select **Local endpoint is an internal interface** to not allow devices on the remote network to see devices on the local network. This causes the Digi device to create a virtual endpoint and assign it the IP address specified later in the settings on this page. Devices on the remote network will only see the IP address of this endpoint, and cannot see the IP addresses of any devices on the local private network. This feature must be used in combination with NAT. If you select it, then you must update the NAT settings on the **Network >IP Forwarding** page. You must enable NAT translation for the VPN interface that corresponds to the tunnel. Tunnel 1 uses interface vpn0, tunnel 2 uses vpn1, etc.
- **VPN Mode:**

If a single remote VPN device will be used for this VPN tunnel, select **Initiate client connections to and accept connections from the remote VPN device at** and enter the remote device's IP address or DNS name in the field below. If the Digi device should accept connections from any remote VPN device for this tunnel, select the **Accept connections from any VPN device** option.
- **Identity settings**
 - **Network Interface: mobile|0eth0:** Select the network interface used to communicate with the remote VPN device. The **mobile0** device is the one with the cellular modem. In most cases, this is the correct device to use to communicate with a remote VPN device on the Internet.
 - **Negotiate tunnel as soon as interface comes up:** Check if the Digi device should establish the VPN tunnel as soon as the selected network interface is ready to use. Leave this box unchecked if the Digi device should wait until a device on the local private network attempts to communicate with a device on the remote network before establishing the VPN tunnel.
 - **Use the following as the identity:** Use this option to control how the Digi device identifies itself to the remote VPN device. The Digi device must identify itself to the remote VPN device when it negotiates the tunnel. You must make sure both devices agree on what the identification is. Select the "Use the following as the identity" option to enter a string such as a DNS name or an FQDN. Select the "Use the interface IP address" if the Digi device should send the IP address of the interface you selected above as its identity. Select **Use the identify certificate X.509...** to use a PKI certificate. If using a PKI certificate, remember to load it in the **Administration >X.509 Certificate/Key Management** web page.

- **Local Endpoint:**

If the Local Endpoint Type is set to **Local endpoint is an internal interface**, the following prompts are displayed:

- **Host address for tunnel's internal VPN interface:** In the **IP Address** field, enter the IP address for the virtual network interface in the IP Address. This is the IP address which will be visible to devices on the remote private network.
- **Discard packets sent to the remote subnet unless they come from this local subnet:** Select this option if the Digi device should discard IP packets transmitted from a device on the local network and addressed to the remote network which do not come from the subnet you specify below.
 - IP Address:** Enter the IP address of the subnet.
 - Subnet Mask:** Enter the mask for the subnet.
- As indicated on the settings page, having the local endpoint as an internal interface is used in combination with NAT. Click here to configure the Network Address Translation (NAT) settings. Select the interface name of vpn0 to configure NAT for this tunnel.

If the Local Endpoint Type is set to **Local endpoint is a subnet**, prompts are displayed for entering the network address and mask for the private network. Both the Digi unit and the remote VPN device must be configured to use the same values.

- **IP Address:** Enter the IP address of the local private network.
- **Subnet Mask:** Enter the mask for the local private network.

- **Remote Endpoint:** Enter the IP address and subnet mask of the remote network. Both the Digi unit and the remote VPN device must be configured to use the same values.

- **Tunnel Network Traffic to the following Remote Network:**
 - IP Address:** Enter the IP address of the remote network.
 - Subnet Mask:** Enter the subnet mask of the remote network.

- **Pre-Shared Key Settings**

If you select the pre-shared key authentication method in one or more of your ISAKMP Phase 1 Policies, then you will be prompted to supply the ID of the VPN device and the preshared key used for authentication.

- **Use the following IP address, FQDN, or username for the remote VPN's ID:** Enter the remote VPN device's ID here. Make sure the remote VPN device is configured to send this ID.
- **Use the following pre-shared key to negotiate IKE security settings:** Enter the preshared key here. This must match exactly with the preshared key set on the remote VPN device.

- **ISAKMP Phase 1 Settings**

- **General Security Settings for Phase 1**

Connection Mode: Main|Aggressive: Set the connection mode to match that configured on the remote VPN device. If aggressive mode is selected, then the VPN device will try aggressive mode first, and then try main mode if aggressive mode fails.

Enable Perfect Forward Secrecy (PFS): Set this option to enable PFS. PFS guarantees that if one key is broken by an attacker, that does not help him to break another key. PFS is more secure, but slows down the negotiation process. Both the Digi unit and the remote VPN device must be configured the same way.

- **NAT-T Settings**

Enable NAT Traversal (NAT-T): Set this option if there is a NAT firewall between the two VPN devices.

Keep Alive Interval: The amount of time in seconds between NAT keep alive messages. Once a connection is established through a firewall, the VPN devices have to send keep alive messages to prevent the NAT firewall from timing out the connection. Set the interval to a value less than the connection timeout of the NAT firewall.

- **ISAKMP Phase 1 Policies:**

Keys are negotiated in two phases. The first phase negotiates the keys and authentication method to be used to establish the initial ISAKMP connection. During this phase, the two VPN devices verify each other's identity and create a security association (encrypted connection) which is used during phase 2. The encryption and authentication settings you specify determine the level of security in the connection the two VPN devices used to communicate with each other.

Select the policies to be used during phase 1 of the ISAKMP negotiation. The most important thing is to make sure that the Digi unit and the remote VPN device use the same policies. If more than one policy is specified, the VPN devices will use the most secure policy that they both have been configured to support.

Pre-shared Key: Using DSS and RSA signatures is more secure than using a pre-shared key.

Encryption: The encryption type and the length of the key. The longer the key the more secure it is.

Integrity: The authentication algorithm. The SHA1 algorithm is more secure than MD5.

SA Lifetime: The maximum length of the phase 1 security association.

Diffie-Hellman: The Diffie-Hellman group to use for key generation. The larger the group the more secure it is.

- **ISAKMP Phase 2 Settings:**

The SAs used for bulk data transfer are created during phase 2. The phase 2 settings you specify will determine the level of security used when devices on the local private network communicate with devices on the remote private network. As with the other settings, the both the Digi unit and the remote VPN device must be configured to use the same values. If more than one policy is specified, the VPN devices will use the most secure policy that they both have been configured to support.

- **General Security Settings for Phase 2**

Diffie-Hellman: Select the Diffie-Hellman group used to generate keys. Larger groups are more secure.

- **ISAKMP Phase 2 Policies**

Encryption: The encryption algorithm used for encrypting data and the length of the key. The longer the key the more secure it is. There are three supported encryption algorithms including DES, 3-DES, and AES. DES encryption uses 64-bit keys, 3-DES encryption uses 192-bit keys, and AES encryption uses 256-bit keys.

Authentication: The authentication algorithm used in authenticating clients. There are two supported authentication algorithms including MD5 and SHA1. MD5 authentication uses 128-bit keys and SHA1 uses 160-bit keys. The SHA1 algorithm is more secure than MD5.

SA Lifetime: The maximum length of the Phase 2 security association (SA), in seconds. After the SA has been negotiated, the SA lifetime begins. Once the lifetime has completed, a new set of SA policies are negotiated with the remote VPN endpoint.

Example VPN configuration

The diagram shows a Digi Connect WAN VPN used as a primary remote site router:

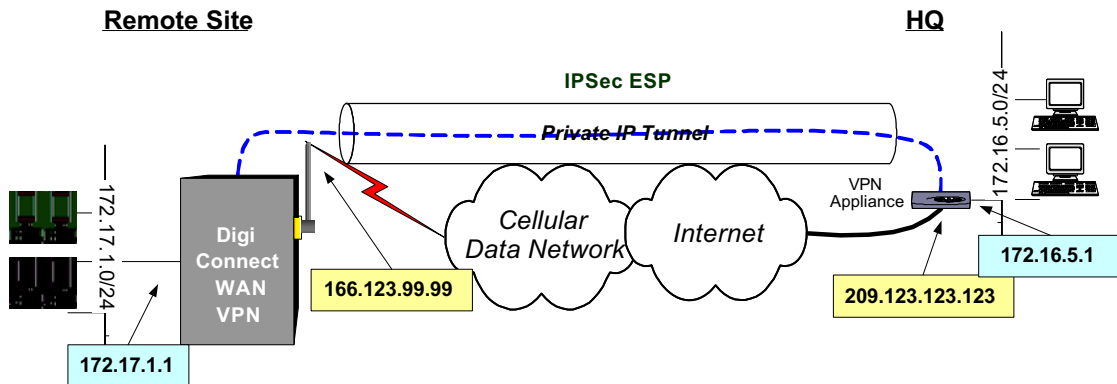

How VPN tunnels work

The Digi device's Ethernet port usually connects to a switch or hub, which then connects to other Ethernet devices. The mobile/cellular carrier provides only one IP address to the mobile interface. The Digi device uses Network Address Translation (NAT), where only the mobile IP address is visible to the outside. Private IP addresses are typically used on the remote site LAN connected to the Digi device's Ethernet port. All outgoing traffic, except the tunneled VPN traffic, uses the mobile IP address of the Digi device. Using the example network above, the process for initiating VPN tunnels works like this:

- 1 Typically, a host or device on the remote subnet (in this case, 172.17.1.0) requests information from a host on the main site (HQ) subnet (172.16.5.0). For example, a computer at 172.17.1.20 needs a file from 172.16.5.100.
- 2 The Digi device sees the request as being on the HQ subnet and checks whether a VPN tunnel exists between the two sites.
- 3 If no tunnel exists, the Digi device initiates a VPN tunnel request to its peer — the VPN concentrator at HQ. The VPN policy settings are compared, and if they match, an IPsec tunnel is created between the Digi device and the VPN concentrator. Traffic is encrypted as defined in the VPN policies.

Requirements for VPN tunnels

To establish an IPsec VPN tunnel, the IP address of the mobile interface must be publicly accessible. The IP address can be either static or dynamic depending upon the requirements of your VPN end point. However, the IP address cannot be within a private range of addresses (for example, 10.0.0.0, 172.16.0.0 or 192.168.0.0). If the mobile IP address is within one of the private IP address ranges, the mobile carrier is using a NAT (Network Address Translation) server between your mobile IP address and the internet.

GSM GPRS/EDGE APN type needed

If the VPN end points require static (persistent) IP addresses, you may need a custom access point name (APN). An Internet APN can work in these cases:

- The main site (HQ) VPN appliance can support Dynamic DNS names.
- Another form of authentication is used (for example, FQDN).

Be aware that these APNs are based on Cingular Blue; other carrier APNs may have similar requirements.

CDMA carrier requirements

The CDMA (Code-Division Multiple Access) carrier requirements are similar to GSM in that static IP addresses may be required depending on the host site concentrator VPN implementation. In both cases, the Digi device's mobile IP address will likely need to support mobile terminated data; that is, the ability to accept incoming data connections.

HQ router / VPN appliance configuration

For supported protocols, see the IPsec specifications your Digi device. Security policies on the HQ VPN device must match those on the Digi device. The HQ VPN appliance's peer address is the Digi device's mobile IP address.

Using a console port

The Digi device's console port can be configured for Console Management to provide SSH or Telnet access. It can be cabled to the router or VPN appliance's console port to provide true diverse out-of-band console access.

Configuring and managing VPN settings from the command line

In the command-line interface, the **set vpn** command configures VPN connections, and the **vpn** command manages them. These commands are described in the *Digi Connect Family Command Reference*. Generally, configuring VPN connections from the web interface is simpler. Review the settings descriptions in this procedure (also available in the online help) to determine whether you need to gather any information before you start setting up the VPN.

IP pass-through settings

There are many application scenarios where a router is used to decide upon alternative routes using a primary and a secondary (or backup) interface. In many of these configurations, the router is required to use a public IP address as assigned by the network over which it is communicating. This requirement is mostly owing to the router needing to establish a VPN tunnel over that interface and using the public IP address as part of the VPN authentication. (For more on VPN tunnels, see page 90.)

The IP pass-through feature allows a Digi device to provide bridging functionality similar to that of a cable or DSL modem, where the Digi device becomes “transparent” to the router or connected device. In this case; the router’s WAN interface believes it is connected directly to the mobile network and has no knowledge that the Digi device is the mechanism providing that connectivity.

How IP pass-through works

A Digi device configured for IP pass-through, such as a ConnectPort WAN or Digi Connect WAN, passes its mobile IP address directly through and to the Ethernet device (router or PC) to which it is connected through the Ethernet port. From the perspective of the connected device, the Digi device essentially becomes transparent (similar to the behavior of a cable or DSL modem) to provide a bridge from the mobile network directly to the end device attached to the Digi device.

Since the mobile network address is effectively “passed-through” to the local device connected to the Ethernet port of the Digi device, all network access to it is bypassed, with some specific exceptions.

Here is an example of a Digi device configured for IP pass-through in a network with a third-party router.

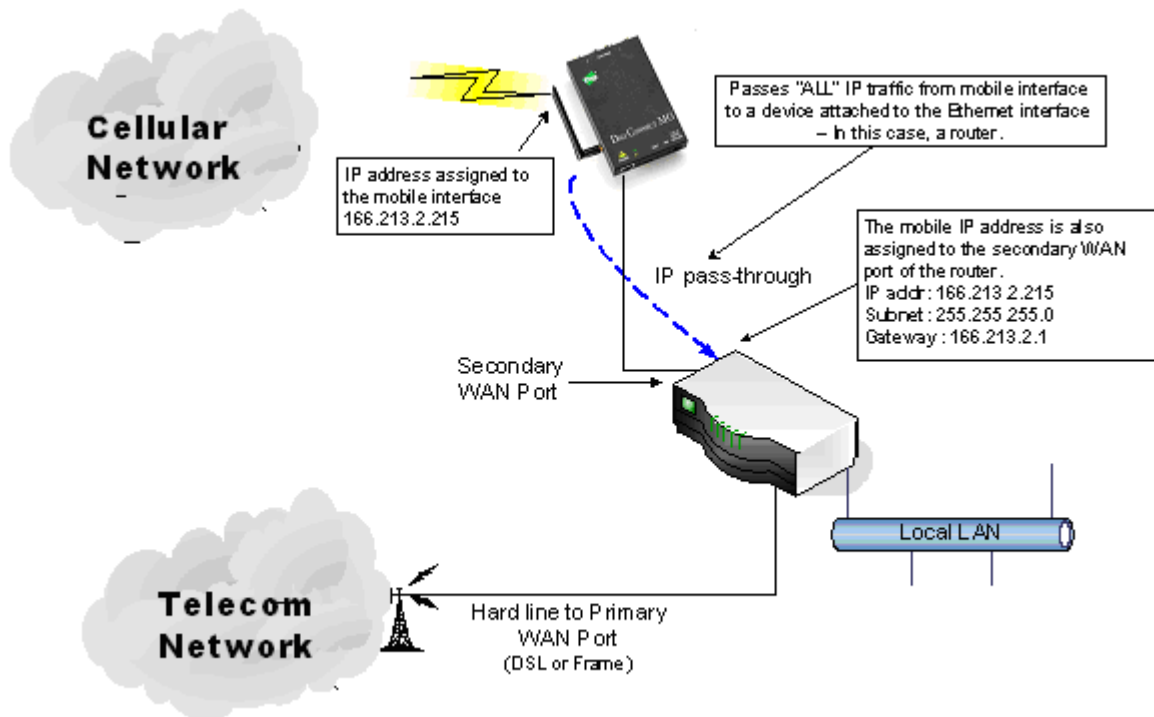

If the third-party router's WAN interface is attached to the Digi device's Ethernet port, and the Digi device's mobile interface receives the IP address 166.213.2.215, the router's WAN port is assigned the same IP address 166.213.2.215. If the router is receiving the IP address dynamically; the DNS server addresses, subnet mask, and default gateway information will be filled in automatically. If the router is configured manually; you need to obtain the DNS information from the mobile service provider and enter that manually. The subnet mask is 255.255.255.0 and the default gateway is the same as the mobile IP address with ".1" for the last octet. In other words: if the mobile IP address is 166.213.2.215, the default gateway is 166.213.2.1.

IP pass-through's effect on network access to Digi devices

When IP pass-through is enabled, the Digi device effectively disables all router and IP service functionality. Services that are disabled are:

- NAT
- Port Forwarding
- VPN
- DDNS updates
- Socket Tunnel
- Network Services configuration.

The Digi device is effectively transparent to all IP activity and network access by other devices, with these exceptions:

- It can be accessed via the serial port for configuration using the command line interface.
- It accepts TCP/IP connections for purposes of configuration by means of a "pinhole" on the mobile interface.
- It can be accessed by other devices on the local Ethernet segment via the default IP address of 192.168.1.1.

Using pinholes to manage the Digi device

IP pass-through uses a concept called *pinholes*. A Digi device can be configured to listen on specific TCP ports, and terminate those connections at the Digi device for purposes of managing it. Those ports are called pinholes, and they are not passed on to the device connected to the Ethernet port of the Digi device. Network services and ports that can be configured as pinholes include (see "Network services settings" on page 75 to configure these settings):

- HTTP: for accessing the device through HTTP and the web interface.
- HTTPS: for accessing to the device through HTTPS and the web interface
- Telnet: for accessing the device through a Telnet login and the command-line.
- SSH: for accessing the device through a Secure Shell (SSH) login and the command-line.
- SNMP: for monitoring and managing the device through SNMP.
- Ping: for accessing the device through ICMP echo (ping) requests

iDigi Platform and Digi SureLink ports are automatically set up as pinholes so that they continue to work with the Digi device. In addition, the Digi device uses a private address on the Ethernet interface strictly for use in configuration or local access. This allows a user on the local network to gain access to the web interface or a Telnet session in order to make configuration changes.

Remote device management and IP pass-through

As illustrated above, the Digi device allows you to enable pinholes for specific ports to allow remote users to manage the Digi device from the mobile network or open Internet. The Digi device retains its remote management capabilities using the iDigi Platform. The necessary pinholes are automatically defined when the Digi device is configured for IP Pass-through. This provides administrators with the same remote-management capabilities that exist in Digi remote devices.

Steps to configure IP pass-through

To configure IP Pass-through from the web interface for your Digi device, follow these steps, or, in the case of the first three steps, make sure they have been performed.

- 1 Set a static IP address for the Digi device. Go to **Configuration > Network > IP Settings**.
- 2 Set up the DHCP server. Go to **Configuration > Network > DHCP Server Settings**. See page 71 and the online help for DHCP Server Settings.
- 3 Turn on the DHCP server. Go to **Management > Network Services**. In **DHCP Server Management**, click the **Start** button.
- 4 Configure IP pass-through settings. Go to **Configuration > Network > IP Pass-through**. IP pass-through settings include:
 - **Enable IP Pass-through:** Enables or disables IP Pass-through.
 - **Pinhole Configuration:** Specifies whether specific network services/ports are configured as pinholes for purposes of managing the Digi device.
- 5 Click **Apply**.

Host List settings

The Host List settings page is used to add or remove entries from the host list. For Digi devices using the DialServ feature, the host list provides a means to map a phone number to a network destination.

The Host List settings are:

- **Local Name:** A phone number
- **Resolves To:** a network destination).
- **Add** button: Adds the entry to the host list

When accessing a device by name, the Digi device will attempt to locate the name within the host list. When a match is found, the host name is mapped to the alias. Typically, this is used as a first means of locating the destination address before using the domain name system (DNS).

Each host list entry consists of a local name string which is mapped to an resolves to destination. The destination can be either an IP Address or Fully Qualified Domain Name (FQDN). By creating several entries, the host list will allow a many-to-one mapping of multiple host names to a single destination, as well as a one-to-many mapping of a host name to multiple destinations. The one-to-many mapping allows a fail-over option - that is, a connection to the resolves to name for the first host match in the list will be tried. If that connection attempt fails, the resolves to name for the next match in the host list will be used.

Virtual Router Redundancy Protocol (VRRP) settings

Virtual Router Redundancy Protocol (VRRP) is a redundancy protocol for routers. VRRP allows several routers on a subnet to use the same virtual IP address, with the physical routers representing a “virtual router.” Two or more physical routers are configured to stand for the virtual router, with only one doing the actual routing at any given time. The virtual router has a unique IP address and MAC address that can be shared by all routers in a VRRP group. The advantage in using a virtual router redundancy protocol is that systems can be configured with a single default gateway, rather than running an active routing protocol.

There are two roles in VRRP: master, and backup. The master represents the virtual router and forwards IP traffic. The physical router that is currently routing the data is known as the Master. If the Master router fails, another Backup router automatically replaces it. Backup routers monitor the health of the master router, and in the event that the master stops sending advertisements, backup routers stage an election to determine which one will be the next master, and take over the virtual router IP address. The time required to make the determination that the master is down and hold elections depends on configuration, but typically occurs in about 3 seconds.

A number of VRRP groups (up to 255) can be configured on a LAN. A router may participate in multiple groups. All routers must be within one hop of each other (does not route).

VRRP settings include:

- **Virtual Router Identifier (VRID):** The virtual router ID. All routers in the same VRID communicate with each other. The VRID can be any value between 1 and 255. All routers that are to communicate must have the same VRID.
- **Priority:** Determines which router is the master. The router with the highest priority is the master. The default priority is 100.
- **Advertisement Interval:** The amount of time in milliseconds between VRRP master advertisements. All routers in the virtual routing group should be set to the same value. 3000 msec (3 seconds) is typically used.
- **Enable Preempt:** This settings controls whether a higher priority Backup router preempts a lower priority Master. Check to enable preemption; uncheck to prohibit preemption. The default setting is enabled (checked).
- **IP Address:** The IP Address of the virtual router. All routers in the same VRID should use the same virtual IP address. Clients should be configured to use this value as their default gateway.

Advanced network settings

The Advanced Network Settings are used to further define the network interface. These settings rarely need to be changed. Contact your network administrator for more information about these settings.

IP Settings

These settings are used to fine-tune IP address settings.

- **Host Name:** The host name to be placed in the DHCP Option 12 field. This is an optional setting which is only used when DHCP is enabled.

The host name is validated and must contain only specific characters. These restrictions are as defined in RFCs 952, 1035, 1123 and 2132. The following characters are permitted:

- Alphabetic: upper and lower case letters A through Z and a through z
- Numeric: digits 0 through 9
- Hyphen (dash): -
- Period (dot): .

The host name value can be a single name, or a fully qualified domain name, whose parts are separated with a period character. Each part must follow the following rules:

- Must begin with a letter or digit
- Must end with a letter or digit
- Interior characters may be a letter, digit or hyphen
- Each part of the name may be from 1 to 63 characters in length, and the full host name may be up to 127 characters in length. An IP address is not permitted for use in this host name setting.

- **Static Primary DNS / Static Secondary DNS:** The IP address of Domain Name Servers (DNS) used to resolve computer host names to IP addresses. Static DNS servers are specified independently of any network interface and its connection state. An IP address of 0.0.0.0 indicates no server is specified.

- **DNS Priority:** A list of DNS servers in priority order used to resolve computer host names. Each type of server is tried, starting with the first in the list. For each server type, the primary server is tried first. If no response is received, then the secondary server is tried. If neither server can be contacted, the next server type in the list is tried.

A network interface may obtain a DNS server from DHCP or other means when it is connected. If an interface does not obtain a DNS server, it will be skipped and the next server in the priority list will be tried.

To change the priority order, select an item from the list and press the up or down arrow.

- **Gateway Priority:** List of network interfaces in priority order used to determine the default gateway. The default gateway is used to route IP packets to an outside network, unless controlled by another route.

A network interface may have a static gateway configured, or obtain a gateway from DHCP or other means when it is connected. The first interface in this list that supplies a gateway will be used as the default gateway. The default gateway may change as interfaces connect and disconnect.

To change the priority order, select an item from the list and press the up or down arrow.

The IP Network Failover feature provides a dynamic method for selecting the default gateway. If failover is properly configured and enabled, it overrides the Gateway Priority selection in the Advanced Network Settings. For a description of the failover feature and information on how to configure it, please see "IP Network Failover settings" on page 85.

DNS Proxy Settings

- Enable DNS Proxy Service:** Enables the DNS Proxy feature on this Digi device. DNS Proxy permits DNS client hosts to communicate with this Digi device as if it were a DNS Server. It forwards the DNS client's request to one of the DNS servers configured in its network settings. The response from the actual DNS server will be relayed to the requesting client when it is received by the DNS Proxy. The DNS Proxy does not cache the actual detailed client requests nor the responses received from the DNS servers. Rather, it acts as a request/response relay agent between the DNS clients and servers. The DNS Proxy will cycle through the DNS servers that are configured in the Digi device. DNS client requests are identified by the client's IP address and the unique Query ID in the DNS request message. For each new DNS client request (new Query ID), the DNS Proxy uses the first DNS server in its list of DNS servers. If the client retries the same request (same Query ID), the DNS Proxy will recognize that retry message and will either send the retry request to the same DNS server as the previous request for this client, or it will move to the next DNS server in its list of DNS servers. The DNS Proxy feature determines when to retry the same DNS server, or move to the next DNS server, according to the **DNS Proxy: Request Retries Per DNS Server** configuration setting (see below). The DNS Proxy itself does not perform unsolicited retries of DNS client requests.

Note The DHCP Server feature on the Digi device may be configured to use the DNS Proxy feature. For more information, see "DHCP server settings" on page 71. The DNS server list may be dynamic in its content. For example, when DNS server IP addresses are received from a mobile service provider's network, they are added to the DNS server list of this Digi device. Those DNS server IP addresses may or may not be configured when the DHCP Server offers a lease to a DHCP client. As a result, the DHCP client may have no DNS servers provided to it in the lease, and domain name resolution may fail for that client. A significant benefit of the DNS Proxy feature is that the DHCP Server can offer its own IP address as a DNS server in the client lease, and the DNS Proxy will forward DNS requests and responses as stated above. Since the DHCP protocol does not allow a DHCP Server to force an unsolicited DNS server list update to its clients, the DNS Proxy feature provides an indirect method by which such updates may be made effective for the client.

- Request Cache Size Maximum:** Specifies the maximum number of DNS client request records that the DNS Proxy will maintain concurrently in its cache. A large cache consumes more system resources than does a small cache. However, if the maximum cache size is too small, new DNS client requests may be quietly discarded until the cache has room to add new client request records, or existing cache entries may be replaced by the new requests. If a large number of concurrent DNS client lookups is anticipated, configuring a larger maximum cache size is recommended. See also the setting **For new client requests received when the request cache is full** below.

- **Request Idle Time-To-Live:** Specifies the period of time, in seconds, that a DNS client request will remain in the DNS Proxy cache, before it is deleted. This is a period of idle time, during which neither a DNS client request retry is received by the DNS Proxy, nor a DNS server response is received by the DNS Proxy, for a specific DNS client request. A shorter **Idle TTL** results in resources being used more efficiently by the DNS Proxy, since the client request cache is reduced in size and the request buffers are released more quickly for future use for other DNS client requests.
- **Request Retries Per DNS Server:** Specifies the number of retries using the same DNS server, for a specific DNS client request that is being retried (retransmitted) by the DNS client. There is always one “try” but the number of retries is configurable.

For new client requests received when the request cache is full:

Specifies how to handle new client requests when the maximum number of client request entries is already being serviced (the request cache is full). There are two choices for this option:

Replace the Least Recently Used (LRU) client request with the new request:

Remove the least recently used entry from the cache, and add an entry for the new client request.

Discard (ignore) new requests until some existing requests have expired:

Silently discard the new client request, and do this for all future new requests until one or more entries have expired and been removed from the request cache.

Ethernet Interface

- **Speed:** The Ethernet speed the Digi device uses on the Ethernet network.
 - **10:** The device operates at 10 megabits per second (Mbps) only.
 - **100:** The device operates at 100 Mbps only.
 - **auto:** The device senses the Ethernet speed of the network and adjusts automatically. The default is **auto**. If one side of the Ethernet connection is using auto (negotiating), the other side can set the Ethernet speed to whatever value is desired. Or, if the other side is set for 100 Mbps, this side must use 100 Mbps.
- **Duplex Mode:** The mode the Digi device uses to communicate on the Ethernet network. Specify one of the following:
 - **half:** The device communicates in half-duplex mode.
 - **full:** The device communicates in full-duplex mode.
 - **auto:** The device senses the mode used on the network and adjusts automatically. The default is **half**. If one side of the Ethernet connection is using auto, the other side can set the duplex value to whatever is desired. If one side uses a fixed value (for example, half-duplex), the other side has to use the same.
- **MDI:** The connection mode for the Ethernet cable.
 - **Auto:** Enables Auto-MDIX mode, where the required cable connection type (straight through or crossover) is automatically detected. The connection is configured appropriately without the need for crossover cables to interconnect switches or connecting PCs peer-to-peer. When it is enabled, either type of cable can be used and the interface automatically corrects any incorrect cabling. For this automatic detection to operate correctly, the “speed” and “duplex” options must both be set to “auto.”
 - **MDI:** The connection is wired as a Media Dependent Interface (MDI), the standard wiring for end stations.
 - **MDIX:** The connection is wired as a Media Dependent Interface with Crossover (MDIX), the standard wiring for hubs and switches.

TCP Keep-Alive Settings

The DHCP server assigns these network settings, unless they are manually set here.

- **Idle Timeout:** The period of time that a TCP connection has to be idle before a keep-alive is sent.
- **Probe Interval:** The time in seconds between each keep-alive probe.
- **Probe Count:** The number of times TCP probes the connection to determine if it is alive after the keep-alive option has been activated. The connection is assumed to be lost after sending this number of keep-alive probes.

WiFi Interface

Digi products with Wi-Fi capability display this setting:

- **Maximum transmission rate:** The maximum transmission rate that the device will use, in megabits per second. The complete range of transmission rates is available on all devices except the ConnectPort X2 - XBee to Wi-Fi model. For that model, the allowed transmission rates are: 1, 2, 5.5, 11.

Mobile (cellular) settings

The Mobile Settings pages configure how to connect to mobile (cellular) networks using the mobile connection, including the service provider, service plan, and connection settings used in connecting to the mobile network. If your Digi device has not already been provisioned for use in the mobile network, you can launch a wizard to provision it from these pages. In addition, you can configure settings for Digi SureLink™, a feature that provides an “always-on” mobile network connection to ensure rapid on-demand communication. The SureLink configuration settings allow you to customize how SureLink detects when a connection has been lost, in order to re-establish the link. These settings also are used to load a preferred roaming list (PRL) into the cellular module.

Information required from mobile service provider

To connect to the mobile network, you must get a set of network settings from the mobile service provider including service plan and authentication details. For more information, consult the documentation that came with your mobile service provider's information.

Different processes used for CDMA and GSM provisioning

The process for provisioning your device and the settings displayed on the Mobile Configuration page vary according to whether the mobile service provider network used with your Digi Cellular Family product is based on CDMA (Code-Division Multiple Access) or GSM (Global System for Mobile communication).

CDMA-based mobile service providers

Device provisioning for a CDMA-based mobile service provider consists of selecting the service provider from a list and either automatically or manually entering mobile settings provided by the mobile service provider. Examples of CDMA-based mobile service providers include Sprint, Verizon, Alltel, and Midwest.

GSM-based mobile service providers

Device provisioning for a GSM-based mobile service provider involves inserting a Subscriber Identity Module (SIM) card into the Digi device, which makes subscription data available in the cellular network. Examples of GSM-based mobile service providers include Cingular, AT&T, and T-Mobile.

Set mobile configuration settings to factory defaults

The **Set to Defaults** button on the Mobile Configuration page sets all the mobile settings to factory defaults and sets the Service Provider selection back to deselected.

Mobile service provider settings

The Mobile Service Provider settings part of the screen identifies the service provider to use in connecting to the mobile network. The information displayed varies by Digi Cellular Family product and whether the remote service provider is GSM- or CDMA-based. Settings that may be displayed on this screen include:

- **Service Provider:** For GSM-based mobile service providers, this is the service provider to use in connecting to the mobile network. The service provider must match the provider that supplied the SIM card. This must match the provider that supplied the SIM card. (Not displayed for CDMA products.)
- **Service Plan:** For GSM-based mobile service providers, this is the service plan to use in connecting to the mobile network. This setting must match the plan that the service provider has supplied to you. This is also sometimes known as the APN (Access Point Name).
- **Username and Password:** For GSM-based mobile service providers, these settings are the username and password of the mobile connection needed to access the mobile network.
- **Device provisioning state:** For CDMA-based mobile service providers, the text below the **Service Provider** selection list states whether the device has already been provisioned. Clicking the **Provision Device** button launches a wizard for provisioning the device. Mobile device provisioning is described next.

Provision a mobile device

Mobile device provisioning is needed to properly configure the Digi device with the required configuration used to access the mobile network. The device must be provisioned before you will be able to create a data connection to the mobile network. The device only needs to be provisioned once. This type of provisioning applies only to Digi devices that have a CDMA cellular module.

For Digi devices, provisioning is done through the Mobile Device Provisioning Wizard, which is launched from the Mobile Configuration page.

Launch the Mobile Device Provisioning Wizard

Below the **Service Provider** selection list is a line of text that states whether or not the device has already been provisioned or needs to be provisioned. If a device has not yet been provisioned, the Mobile Configuration page displays a message, as shown below. Click the **Provision Device** button to launch the Mobile Device Provisioning Wizard. For example, here is how the **Mobile Settings** page looks when a device has not yet been provisioned.

The screenshot shows the 'Mobile Configuration' interface. At the top, there is a blue header with the text 'Mobile Configuration'. Below this is a section titled 'Mobile Settings' with a dropdown arrow. The text below reads: 'Select the service provider, service plan, and connection settings used in connecting to the mobile network. These settings are provided by and can be retrieved from the service provider.' Underneath is a section titled 'Mobile Service Provider Settings' with a 'Service Provider:' label and a dropdown menu currently set to 'Sprint PCS'. Below this, a red message states 'This device needs to be provisioned:' followed by a 'Provision Device' button. The next section is 'Mobile Connection Settings', which includes a checked checkbox for 'Re-establish connection when no data is received for a period of time.' and an 'Inactivity timeout:' field set to '3600' seconds. At the bottom of this section are 'Apply' and 'Set to Defaults' buttons. Finally, there is a section titled 'SureLink Settings' with a right-pointing arrow.

Automatic versus manual provisioning

There are different types of provisioning methods depending upon your mobile provider. The Mobile Device Provisioning Wizard will provide the appropriate choices based on the mobile provider selected. Two main provisioning methods are:

- **Automatic Provisioning:** Typically, an automatic provisioning process called IOTA (IP-Based Over the Air) is used to provision the device. Note that automatic provisioning requires the modem device to communicate over the mobile network and requires a good signal to ensure proper provisioning.
- **Manual Provisioning:** Alternatively, a manual provisioning method can be used to manually specify the required fields needed to access the mobile network. The manual provisioning method is an advanced configuration normally used only for custom network access or providers. This method is not available for all mobile providers, and will not be available in the Mobile Device Provisioning Wizard if your mobile provider does not support it.

Example: provision ConnectPort WAN VPN for Sprint™ PCS

The sequence of Mobile Device Provisioning Wizard screens displayed and the settings on them vary by product and mobile service provider. If you used the Digi Device Setup Wizard for initial configuration of your Digi device, and selected a service provider in the wizard, some of the provisioning settings will have already been established.

Here is an example of the wizard screens for a ConnectPort WAN VPN using Sprint PCS as the mobile service provider.

1 Select a mobile service provider from the list.

Mobile Provisioning Configuration
Verify that the configured mobile provider is correct.

Each service provider uses a different procedure to provision the mobile device. Verify that the configured mobile service provider below is correct:

Service Provider:

2 Select automatic or manual provisioning.

The main difference between automatic and manual provisioning is that manual provisioning involves entering more information. You will have received all of this information from your mobile service provider during account setup.

Mobile Device Provisioning
Specify the method in which to provision the mobile device. This information is available from the mobile provider.

Mobile Device Provisioning is needed to properly configure the mobile device with the required configuration used to access the mobile network. Typically, an automatic provisioning process called IOTA (IP-Based Over the Air) is used to provision the device. Note that automatic provisioning requires the modem device to communicate over the mobile network and requires a good signal to ensure proper provisioning.

Alternatively, a manual provisioning method can be used to manually specify the required fields needed to access the mobile network. The manual provisioning method is an advanced configuration normally used only for custom network access or providers.

Automatically provision the mobile device

Manually provision the mobile device

3 As needed, enter device provisioning information provided by your mobile service provider.

On some modules, the provisioning information is already obtained and automatically entered. If the screen below is displayed, enter the provisioning information.

Mobile Provisioning Configuration
Specify the required settings needed to provision this device. This information is available from the mobile provider.

The following settings are required to provision the mobile device. These settings should have been provided by or should be available from the mobile provider when the account was created.

Service Programming Code:

Mobile Directory Number:

MSID (IMSI_MS):

4 Device provisioning in progress...

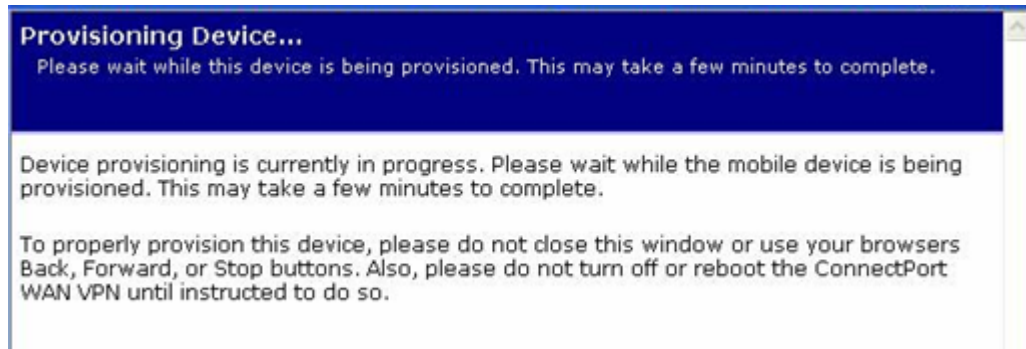

5 Provisioning complete.

Upon successful completion of provisioning, a screen is displayed stating that the provisioning was successful. Click **Finish**.



If provisioning fails:

The first screen of the provisioning wizard is displayed again. Instead, you must perform manual provisioning.

6 Click Apply on the Mobile Configuration page to complete the provisioning.

Re-provision a Digi device

Re-provisioning a Digi device simply consists of going through the Mobile Device Provisioning Wizard again.

Mobile connection settings

Mobile connection settings configure how the mobile connection is established and maintained.

- **Re-establish connection when no data is received for a period of time:**
Inactivity timeout: Whether the mobile connection will be disconnected and re-established after no data has been received over the link for the specified amount of time, in seconds.

Advanced settings

The following options configure advanced settings to manage the mobile PPP connection established by the Digi device. Unless otherwise stated, the mobile PPP connection is not restarted with the new settings when the changes are applied (saved). The changes are applied the next time the mobile PPP connection is restarted.

Mobile Band Settings

Select the mobile service frequency bands to be configured in the modem. The default selection **Automatic** should be used unless there is a reason to configure specific bands only.

Note: The mobile PPP connection is not automatically restarted when a band selection is configured.

- **Automatic:** Enables automatic service band selection by the modem.
- **Manual:** Selects the individual service bands to be configured. Improper selection or combinations may result in a failure to establish a mobile connection. Select one or more of these values:
 - 850 MHz
 - 900 MHz
 - 1800 MHz
 - 1900 MHz

Mobile Carrier Settings

Mobile carrier selection allows the mobile device to be configured to use a specific mobile service only. The recommended and normal operation is for the mobile device to automatically find service with an available carrier. However, a manual selection can be configured to force the use of a particular carrier. Please be aware that use of a manual carrier selection can result in a significantly longer time interval for the unit to find service on the specified network. Both the mobile network and the mobile device (modem) may influence this behavior. Therefore it is recommended that the **Automatic** selection be used wherever possible.

Warning: The scan for available carriers requires that the mobile PPP connection be terminated to perform the scan. A successful scan cannot be performed and completed if it is initiated over the mobile connection, since the scan procedure requires user interaction that is not possible after the mobile PPP connection has been terminated.

- **Automatic:** Enables automatic selection of a carrier for the mobile service connection. The mobile PPP connection is not automatically restarted if automatic carrier selection is configured.
- **Manual:** Enables manual selection of the Network ID of a carrier for the mobile service connection. The carrier selection is the concatenation of the Mobile Country Code (MCC) and Mobile Network Code (MNC) value for a carrier. The MCC is always a three-digit decimal value, and the MNC is either a two- or three-digit decimal value. A properly entered Network ID is composed of five or six decimal digits, with no other characters in that value.

The **Scan available carriers...** link initiates a wizard that instructs the modem to scan for available carriers and display a list from which the desired carrier may be selected. The scan may take as little as 20 seconds or up to two minutes to complete. Scanning for carriers requires that the mobile PPP connection be terminated so the scan may be performed. Upon completion of the wizard, the mobile PPP connection is restarted using the selected carrier.

Note: If the **Mobile Band Settings** selection in use by the modem is other than **Automatic**, the list of carriers returned by the scan may include only a subset of the carriers available in the area.

The Network ID from a carrier selection from the list may be manually entered. However, the mobile PPP connection is not automatically restarted if the manual entry method is used.

Digi SureLink™ settings

The Mobile Connection Settings configure Digi SureLink™ settings for a Digi device. SureLink ensures that a Digi device is in a state where it can connect to the mobile network, and they can be used to monitor the integrity of the established mobile connection.

There are two groups of SureLink settings:

- **Hardware Reset Thresholds:** These settings can be configured to clear any error states that were resident in the Digi device's cellular module, so the device can once again connect to the network, if the connection is lost. It does this by first resetting the cellular module after a default or specified number of consecutive failed connection attempts, and then resetting the Digi device after a default or specified number of failed consecutive connection attempts. Each of these connection-failure settings can be disabled as well.
- **Link Integrity Monitoring settings:** These settings can be configured to perform a selected test to examine the functional integrity of the network connection, and take action to recover the connection in the event that it is lost.

Hardware reset thresholds

- **Hard reset the modem module after the following number of consecutive failed connections:** Enables or disables a hard reset of the cellular modem module after the specified number of failed connection attempts. This value can be a number between 1 and 255. The default is 3.
- **Power-cycle the device after the following number of consecutive failed connections:** Enables or disables a power-cycle of the Digi device after the specified number of failed connection attempts. This value can be a number between 1 and 255. The default is 0, or off.

Link integrity monitoring settings

- **Enable Link Integrity Monitoring using the test method selected below:** Enables or disables the link integrity monitoring tests. If this setting is enabled, the other Link Integrity Monitoring settings may be configured and are used to verify the functional integrity of the mobile connection. The default is off (disabled).

There are three tests available:

- Ping Test
- TCP Connection Test
- DNS Lookup Test

You can use these tests to demonstrate that two-way communication is working over the mobile connection. Several tests are provided because different mobile networks or firewalls may allow or block Internet packets for various services. Select the appropriate test may be selected according to mobile network constraints and your preferences.

The link integrity tests are performed only while the mobile connection is established. If the mobile connection is disconnected, the link integrity tests are suspended until the connection is established again.

For the link integrity tests to provide meaningful results, the remote or target hosts must be accessible over the mobile connection and not through the LAN interface of the device (if it has one). That is, the settings should be configured to guarantee that the mobile connection is actually being tested.

The link integrity test settings may be modified at any time. The changes are used at the start of the next test interval.

- **Ping Test:** Enables or disables the use of “ping” (ICMP) as a test to verify the integrity of the mobile connection. The test is successful if a valid ping reply is received in response to the ping request sent. The ping test actually sends up to three ping requests, at three second intervals, to test the link. When a valid reply is received, the test completes successfully and immediately. If a reply is received for the first request sent, there is no need to send the other two requests.

Two destination hosts may be configured for this test. If the first host fails to reply to all three ping requests, the same test is attempted to the second host. If neither host replies to any of the ping requests sent, the test fails. The primary and secondary addresses may be either IP addresses or fully qualified domain names.

- **Primary Address:** First host to test.
- **Secondary Address:** Second host to test (if the first host fails).

- **TCP Connection Test:** Enables or disables the creation of a new TCP connection as a test to verify the integrity of the mobile connection. The test is successful if a TCP connection is established to a specified remote host and port number. If the remote host actively refuses the connection request, the test is also considered to be successful, since that demonstrates successful two-way communication over the mobile connection. The TCP connection test waits up to 30 seconds for the connection to be established or refused. When the TCP connection is established, the test completes successfully, and the TCP connection is closed immediately.

Two destination hosts may be configured for this test. If the first host fails to establish (or refuse) the TCP connection, the same test is attempted to the second host. If neither host successfully establishes (or refuses) the TCP connection, the test fails. The primary and secondary addresses may be either IP addresses or fully qualified domain names.

- **TCP Port:** The TCP port number to connect to on the remote host (default 80).
- **Primary Address:** The address of the first host to test.
- **Secondary Address:** The address of the second host to test (if the first host fails).

- **DNS Lookup Test:** Enables or disables the use of a Domain Name Server (DNS) lookup as a test to verify the integrity of the mobile connection. The test is successful if a valid reply is received from a DNS server. Typically, this means the hostname is successfully “resolved” to an IP address by a DNS server. But even a reply such as “not found” or “name does not exist” is acceptable as a successful test result, since that demonstrates successful two-way communication over the mobile connection. When a valid reply is received, the test completes successfully and immediately.

The DNS servers used in this test for the hostname lookup, are the primary and secondary DNS servers obtained from the mobile network when the mobile PPP connection is first established. These addresses can be viewed by going to **Administration > System Information > Mobile**.

Note that this DNS test is independent of the normal DNS client configuration and lookup cache, which is used for other hostname lookups. This test has been specifically designed to require communication over the mobile connection for each lookup, and to avoid being “short-circuited” by previously cached information. Also, this test does not interfere in any way with the normal DNS client configuration of this device.

Two hostnames may be configured for this test. If the first hostname fails to get a reply, the same test is attempted for the second hostname. If no reply is received for either hostname, the test fails. The primary and secondary DNS names should be fully qualified domain names. Note that the reverse lookup of an IP address is possible, but that is usually unlikely to succeed in returning a name. Still, such a reverse lookup can be used to demonstrate the integrity of the mobile connection.

- **Primary DNS Name:** The first hostname to look up.
- **Secondary DNS Name:** The second hostname to look up (if the first hostname fails).

- **Repeat the selected link integrity test every *N* seconds:** Specifies the interval, in seconds, at which the selected test is initiated (repeated). A new test will be started every *N* seconds while the mobile connection is established. This value must be between 10 and 65535. The default is 240.

If the configured interval is less time than it takes a test to complete, the next test will not be initiated until the previous (current) test has completed.

- **Test only when idle:** if no data is received for the above period of time: Specifies that the test repeat interval (above) is to be used as an idle period interval. That is, initiate the selected link integrity test only after no data has been received for the specified interval of time. This changes the behavior of the test in that the test interval varies according to the presence of other data received from the mobile connection.

Although using this idle option may result in less data being exchanged over the mobile connection, it also prevents the link integrity tests from running as often to verify the true bi-directional state of that connection.

- **Reset the link after the following number of consecutive link integrity test failures:** Specifies that after the configured number of consecutive link integrity test failures, the mobile connection should be disconnected and reestablished. This value must be between 1 and 255. The default is 3. When the mobile connection is reestablished, the “consecutive failures” counter is reset to zero.

If the mobile connection is disconnected for any reason (including not as a result of a link integrity test failure), the consecutive failures count is reset to zero when the mobile connection is reestablished.

Status and statistical information for mobile connections

Once the mobile settings have been configured, you can monitor the status of mobile connections by going to **Administration > System Information > Mobile**. See "Mobile information and statistics" on page 191.

From the command line, this mobile information is displayed by issuing **display mobile** and **display pppstats** commands.

Update PRL settings

Note These settings apply to Digi cellular-enabled products that use the Sierra Wireless MC57xx series CDMA/EVDO modules.

The Update PRL page is for loading a preferred roaming list (PRL) into the cellular module on the Digi device. A PRL is a database that resides in a mobile device that contains information used during the system selection and acquisition process. It is built by the mobile service provider, and is normally not accessible to users. The PRL indicates which bands, sub bands and service provider identifiers will be scanned and in what priority order. Without a PRL, a mobile device may not be able to roam, or obtain service outside of the home area. There may be cases where missing or corrupt PRL's can lead to not having service at all.

On many networks, regularly updating the PRL is advised if the subscriber uses the device outside the home area frequently, particularly if they do so in multiple different areas. This allows the mobile device to choose the best roaming carriers, particularly “roaming partners” with whom the home carrier has a cost-saving roaming agreement, rather than using non-affiliated carriers. PRL files can also be used to identify home networks along with roaming partners, thus making the PRL an actual list that determines the total coverage of the subscriber, both home and roaming coverage.

To load a PRL, fill in values for these settings:

- **PRL File:** The location and name of the PRL file to be loaded into the cellular module. Enter the PRL file's pathname or click the Browse button and use the browse dialog to select the file.
- **MSL/OTSL:** The master subsidy lock (MSL) or a one-time subsidy lock (OTSL) associated with the module. This value is a six-digit activation or unlock code supplied by the mobile service provider.

Click the Upload button to upload the PRL file to the cellular module.

If the PRL loading/updating operation was successful, the status message PRL update successful is displayed in a blue box above the settings.

If an error occurs, a red box with a message describing the error is displayed above the settings.

PRL updates can also be done over the air by dialing the over-the-air (OTA) feature code *228.

Short Message Service (SMS) settings

The following options configure the cellular Short Message Service (SMS) capabilities of the mobile module of the Digi device.

Important Notes:

- Currently, SMS is supported for Digi devices with GSM cellular modems only. To determine whether the cellular modem in a Digi device supports SMS, Telnet to the command line and enter the **show smscell** command. If an error message is returned (**error: show option not found**), then SMS is not supported for that Digi device.
- SMS is a feature that may be available as part of your mobile service agreement. However, sending and receiving short messages (or “text messages”) may have additional costs. Before using the SMS capabilities of your Digi device, verify with your mobile service provider that your agreement includes SMS as part of your service plan. Understand the costs of SMS before you enable the SMS features on this Digi device.
- Please read "Supported Character Set" on page 125.

Global SMS settings

- **Enable cellular Short Message Service (SMS) capabilities:** Enable SMS features on this Digi device. When this option is enabled, the remaining SMS options may be configured. This option is disabled (off) by default.
- **Send ACK reply via SMS when command is accepted:** When a command message is received via SMS, send an acknowledgement (ACK) message via SMS to the originator of the command message, indicating that the command has been accepted and will be processed. This option is disabled (off) by default.
- **Send NAK reply via SMS if password validation fails:** When a command message is received via SMS, and a required password is either missing or incorrect, send a negative acknowledgement (NAK) message via SMS to the originator of the command message, indicating that the command has been rejected due to password validation failure. This option is disabled (off) by default.
- **Global SMS Command Password:** When a command message is received via SMS, and a global password is specified in these settings, that password must be provided by the originator of the command message or the message will be rejected by the Digi device. If a command-specific password is configured, that command-specific password must be provided instead of this global command password. Specifically, a command-specific password overrides the global password, and the global password is not considered if a command-specific password is configured in the settings. This option is disabled (no global password required) by default. To remove the password, simply clear the password field on the settings page.

- **Default Message Receiver:** When a message is received via SMS, the **Default Message Receiver** is used to determine which SMS “user” will receive the message and process it. This handling pertains to messages that are not enabled commands for which command processing is performed. The choices for this option are:
 - **Log Only:** The received message is logged but otherwise not processed (default option).
 - **Python:** The received message is passed to the standard Python receiver. Further processing of the message text is the responsibility of the Python program that is implemented to receive SMS messages. Note that these messages are logged when they are placed on the Python read queue.
- **Enable extended detail for SMS event logging (verbose):** The SMS feature normally records limited, relevant activities to the system event log. These log entries identify SMS initialization, reconfiguration, and message send/receive activities. For troubleshooting purposes, the message send and receive activity logging can be recorded in greater detail by enabling this option. However, this can result in filling the event log with more SMS activity records than are useful for normal operation, and it is recommended that this option should be enabled only if greater detail is required for some interval of time. This option is disabled (off) by default.

Python settings

Python-related settings for the SMS feature include:

- **Enable SMS support for Python:** Enable SMS features for Python on this Digi device. When this option is enabled, the remaining Python-specific SMS options may be configured. This option is enabled (on) by default.
- **Received Message Queue Maximum:** The number of received messages that may be placed on the dedicated Python SMS message read queue awaiting processing by Python. Once this limit is reached, new received messages are logged but discarded until the read queue falls below this configured maximum message count. The default value for this setting is 100 messages.
- **Received Message Hold Time Maximum:** The maximum amount of time in seconds that a received message will be held on the dedicated Python SMS message read queue while waiting for Python SMS message processing to be brought into service. This setting allows messages to be received and queued for Python before the Python program that processes them is ready to receive such messages, thereby eliminating loss of messages that are received before the Python program is ready to handle them. The default value for this setting is 600 seconds (10 minutes).
- **Python SMS Password:** Although this use is not typical, a message may be directed for deliver to Python by sending “#python” as a command to this Digi device. In such a case, this Python password may be configured to validate the acceptance of such a command message before it is accepted and placed on the dedicated Python SMS message read queue for further processing. When Python is configured as the **Default Message Receiver**, it is not necessary to use the Digi device command message syntax, since all otherwise unhandled messages will be delivered to the Python read queue. However, password validation is not performed for non-command messages. This option is disabled (no Python password required) by default. To remove the password, simply clear the password field on the settings page.

Built-In Command Settings

A number of Built-In Commands are supported for execution via SMS messages sent to your Digi device. Descriptions of built-in command-related settings for the SMS feature follow. Full detailed descriptions of the SMS command syntax and supported command options is available on the Digi support web site.

Supported commands

The following commands are supported.

| Built-in command | Description |
|---------------------------------------|--|
| #help (alias #?) | The Digi device replies to the sender via SMS with a message that specifies the command syntax and a list of the supported, available commands that may be sent to this device. You may obtain further help for a specific command by sending that command as a parameter. E.g., send “#help ping” to request a help reply for the “#ping” built-in command. |
| #cli | Request that a CLI command be run on the Digi device. The output from the CLI command is returned to the sender via SMS, with a limit of around 2000 characters for the number of CLI output characters returned in the reply. |
| #idigi (alias #cwm) | Manage or obtain status for a device connection to a Digi iDigi (Connectware Manager) server. The Digi device replies to the sender via SMS with a message that contains the status or result of the requested action. |
| #ping | Request that the Digi device reply to the sender via SMS to verify two-way SMS communication between the sender and the Digi device. |

Command options

For each built-in command, the following options are supported:

- **Enable**
The command is enabled for use via SMS. All commands are enabled by default.
- **Password**
The configured password must be specified on the command message for that message to be accepted for further processing. If a command-specific password is configured, that command-specific password must be provided instead of the global command password (if one is configured, see **Global SMS Command Password** above). Specifically, a command-specific password overrides the global password, and the global password is not considered if a command-specific password is configured in the settings. This option is disabled (no command password required) by default. To remove the password, simply clear the password field on the settings page.

Sender Control List (SCL) Settings

The Sender Control List (SCL) permits the user to select the addresses (or phone numbers) from which SMS messages will be accepted. This is in effect a “Caller ID” capability in which message senders are screened by the Digi device and either processed or discarded according to the configured SCL rules.

Following are descriptions of the SCL-related settings for the SMS feature.

- **Enable SMS Sender Control List:** Enable the Sender Control List capabilities on this Digi device. When this option is enabled, the remaining SCL-specific SMS options may be configured. This option is disabled (off) by default.
- **Send NAK reply via SMS if received message is rejected by SCL:** When a message is received via SMS, SCL is enabled, and the sender is not permitted by the SCL rules, send a negative acknowledgement (NAK) message via SMS to the originator of the command message, indicating that the message has been rejected due to the configured SCL rules. This option is disabled (off) by default.

For each SCL rule, the following options may be configured:

- **Enable:** The rule is enabled for use by SMS. Rules may be enabled and disabled without removing them altogether from the SCL. Disabled rules are ignored when examining received messages.
- **Sender Address (Phone Number):** The address (phone number) of the sender for which this rule applies. If the sender's address matches this configured address, the SMS message is accepted for further processing. If the sender's address does not match any of the enabled SCL rule addresses, it is rejected and no further processing is performed. To remove the address, simply clear the address field on the settings page.
- **Match Type:** The type of address match test that is to be performed for this rule. There are four supported match types:
 - **Exact:** The sender's address must match exactly the address configured for this rule.
 - **Right:** The sender's address must match the address configured for this rule when comparing the rightmost characters to the shorter of the two strings (sender address, rule address). For example, “5551212” matches “13125551212” since the rightmost characters match to the length of the shorter string, “5551212”. This is the default match type.
 - **Left:** The sender's address must match the address configured for this rule when comparing the leftmost characters to the shorter of the two strings (sender address, rule address). For example, “1312555” matches “13125551212” since the leftmost characters match to the length of the shorter string, “1312555”.
 - **Partial:** The sender's address must match the address configured for this rule when comparing the consecutive characters to the shorter of the two strings (sender address, rule address). For example, “312555” matches “13125551212” since the shorter string “312555” is a substring of the longer string “13125551212”.

Supported Character Set

For SMS via GSM service, it is necessary to translate between the GSM 03.38 7-bit alphabet and ASCII, which is the native character set for the Digi device and is the character set used in the CLI and web UI.

The characters of ASCII and GSM 03.38 do not map one-to-one, and in fact some ASCII characters must be represented in GSM 03.38 as multi-character escape sequences (per extensions to the original GSM 03.38 alphabet). In the table below, such characters are shown as “0x1Bhh” under the “GSM 03.38 Code” column. This notation indicates a two-character sequence, where “hh” is a pair of hexadecimal digits.

In the reverse translation (from GSM 03.38 to ASCII), some of the GSM 03.38 characters have no ASCII counterpart. These are replaced with ASCII space characters. One exception is the INVERTED QUESTION MARK (0x60 in GSM 03.38) which is replaced with an ASCII QUESTION MARK (0x3F) character.

The following table documents the supported characters and the mapping used between these two alphabets. Note that “unknown” characters are replaced with space characters during the translation. In the table below, such characters are shown as “0x20 *” under the “GSM 03.38 Code” column.

Notes for the table:

- (1) The GRAVE ACCENT character (0x60) in ASCII has no counterpart in GSM 03.38. A substitution is made using the APOSTROPHE (0x27) in its place.
- * The characters marked with * indicate a substitution since the ASCII characters have no counterpart in GSM 03.38. These characters are replaced with the SPACE (0x20) character. As such, these characters are not supported in the Digi product support of GSM short messages.

Supported character set

| ASCII Code | GSM 03.38 Code | ASCII Character | Description |
|------------|----------------|-----------------|-----------------------|
| 0x00 | 0x20 * | NUL | NULL |
| 0x01 | 0x20 * | SOH | START OF HEADING |
| 0x02 | 0x20 * | STX | START OF TEXT |
| 0x03 | 0x20 * | ETX | END OF TEXT |
| 0x04 | 0x20 * | EOT | END OF TRANSMISSION |
| 0x05 | 0x20 * | ENQ | ENQUIRY |
| 0x06 | 0x20 * | ACK | ACKNOWLEDGE |
| 0x07 | 0x20 * | BEL | BELL |
| 0x08 | 0x20 * | BS | BACKSPACE |
| 0x09 | 0x20 * | HT | HORIZONTAL TABULATION |
| 0x0A | 0x0A | LF | LINE FEED |
| 0x0B | 0x20 * | VT | VERTICAL TABULATION |
| 0x0C | 0x1B0A | FF | FORM FEED |
| 0x0D | 0x0D | CR | CARRIAGE RETURN |
| 0x0E | 0x20 * | SO | SHIFT OUT |
| 0x0F | 0x20 * | SI | SHIFT IN |
| 0x10 | 0x20 * | DLE | DATA LINK ESCAPE |
| 0x11 | 0x20 * | XON | DEVICE CONTROL ONE |
| 0x12 | 0x20 * | DC2 | DEVICE CONTROL TWO |
| 0x13 | 0x20 * | XOFF | DEVICE CONTROL THREE |
| 0x14 | 0x20 * | DC4 | DEVICE CONTROL FOUR |
| 0x15 | 0x20 * | NAK | NEGATIVE ACKNOWLEDGE |
| 0x16 | 0x20 * | SYN | SYNCHRONOUS IDLE |

Supported character set (Continued)

| ASCII Code | GSM 03.38 Code | ASCII Character | Description |
|------------|----------------|-----------------|---------------------------|
| 0x17 | 0x20 * | ETB | END OF TRANSMISSION BLOCK |
| 0x18 | 0x20 * | CAN | CANCEL |
| 0x19 | 0x20 * | EM | END OF MEDIUM |
| 0x1A | 0x20 * | SUB | SUBSTITUTE |
| 0x1B | 0x20 * | ESC | ESCAPE |
| 0x1C | 0x20 * | FS | FILE SEPARATOR |
| 0x1D | 0x20 * | GS | GROUP SEPARATOR |
| 0x1E | 0x20 * | RS | RECORD SEPARATOR |
| 0x1F | 0x20 * | US | UNIT SEPARATOR |
| 0x20 | 0x20 | SP | SPACE |
| 0x21 | 0x21 | ! | EXCLAMATION MARK |
| 0x22 | 0x22 | " | QUOTATION MARK |
| 0x23 | 0x23 | # | NUMBER SIGN |
| 0x24 | 0x02 | \$ | DOLLAR SIGN |
| 0x25 | 0x25 | % | PERCENT SIGN |
| 0x26 | 0x26 | & | AMPERSAND |
| 0x27 | 0x27 | ' | APOSTROPHE |
| 0x28 | 0x28 | (| LEFT PARENTHESIS |
| 0x29 | 0x29 |) | RIGHT PARENTHESIS |
| 0x2A | 0x2A | * | ASTERISK |
| 0x2B | 0x2B | + | PLUS SIGN |
| 0x2C | 0x2C | , | COMMA |
| 0x2D | 0x2D | - | HYPHEN-MINUS |
| 0x2E | 0x2E | . | FULL STOP (PERIOD) |
| 0x2F | 0x2F | / | SOLIDUS (SLASH) |
| 0x30 | 0x30 | 0 | DIGIT ZERO |
| 0x31 | 0x31 | 1 | DIGIT ONE |
| 0x32 | 0x32 | 2 | DIGIT TWO |

Supported character set (Continued)

| ASCII Code | GSM 03.38 Code | ASCII Character | Description |
|------------|----------------|-----------------|------------------------|
| 0x33 | 0x33 | 3 | DIGIT THREE |
| 0x34 | 0x34 | 4 | DIGIT FOUR |
| 0x35 | 0x35 | 5 | DIGIT FIVE |
| 0x36 | 0x36 | 6 | DIGIT SIX |
| 0x37 | 0x37 | 7 | DIGIT SEVEN |
| 0x38 | 0x38 | 8 | DIGIT EIGHT |
| 0x39 | 0x39 | 9 | DIGIT NINE |
| 0x3A | 0x3A | : | COLON |
| 0x3B | 0x3B | ; | SEMICOLON |
| 0x3C | 0x3C | < | LESS-THAN SIGN |
| 0x3D | 0x3D | = | EQUALS SIGN |
| 0x3E | 0x3E | > | GREATER-THAN SIGN |
| 0x3F | 0x3F | ? | QUESTION MARK |
| 0x40 | 0x00 | @ | COMMERCIAL AT |
| 0x41 | 0x41 | A | LATIN CAPITAL LETTER A |
| 0x42 | 0x42 | B | LATIN CAPITAL LETTER B |
| 0x43 | 0x43 | C | LATIN CAPITAL LETTER C |
| 0x44 | 0x44 | D | LATIN CAPITAL LETTER D |
| 0x45 | 0x45 | E | LATIN CAPITAL LETTER E |
| 0x46 | 0x46 | F | LATIN CAPITAL LETTER F |
| 0x47 | 0x47 | G | LATIN CAPITAL LETTER G |
| 0x48 | 0x48 | H | LATIN CAPITAL LETTER H |
| 0x49 | 0x49 | I | LATIN CAPITAL LETTER I |
| 0x4A | 0x4A | J | LATIN CAPITAL LETTER J |
| 0x4B | 0x4B | K | LATIN CAPITAL LETTER K |
| 0x4C | 0x4C | L | LATIN CAPITAL LETTER L |
| 0x4D | 0x4D | M | LATIN CAPITAL LETTER M |
| 0x4E | 0x4E | N | LATIN CAPITAL LETTER N |

Supported character set (Continued)

| ASCII Code | GSM 03.38 Code | ASCII Character | Description |
|------------|----------------|-----------------|--------------------------------|
| 0x4F | 0x4F | O | LATIN CAPITAL LETTER O |
| 0x50 | 0x50 | P | LATIN CAPITAL LETTER P |
| 0x51 | 0x51 | Q | LATIN CAPITAL LETTER Q |
| 0x52 | 0x52 | R | LATIN CAPITAL LETTER R |
| 0x53 | 0x53 | S | LATIN CAPITAL LETTER S |
| 0x54 | 0x54 | T | LATIN CAPITAL LETTER T |
| 0x55 | 0x55 | U | LATIN CAPITAL LETTER U |
| 0x56 | 0x56 | V | LATIN CAPITAL LETTER V |
| 0x57 | 0x57 | W | LATIN CAPITAL LETTER W |
| 0x58 | 0x58 | X | LATIN CAPITAL LETTER X |
| 0x59 | 0x59 | Y | LATIN CAPITAL LETTER Y |
| 0x5A | 0x5A | Z | LATIN CAPITAL LETTER Z |
| 0x5B | 0x1B3C | [| LEFT SQUARE BRACKET |
| 0x5C | 0x1B2F | \ | REVERSE SOLIDUS (BACKSLASH) |
| 0x5D | 0x1B3E |] | RIGHT SQUARE BRACKET |
| 0x5E | 0x1B14 | ^ | CIRCUMFLEX ACCENT |
| 0x5F | 0x11 | _ | LOW LINE (UNDERScore) |
| 0x60 | 0x27 (1) | ` | GRAVE ACCENT |
| 0x61 | 0x61 | a | LATIN SMALL LETTER A |
| 0x62 | 0x62 | b | LATIN SMALL LETTER B |
| 0x63 | 0x63 | c | LATIN SMALL LETTER C |
| 0x64 | 0x64 | d | LATIN SMALL LETTER D |
| 0x65 | 0x65 | e | LATIN SMALL LETTER E |
| 0x66 | 0x66 | f | LATIN SMALL LETTER F |
| 0x67 | 0x67 | g | LATIN SMALL LETTER G |
| 0x68 | 0x68 | h | LATIN SMALL LETTER H |
| 0x69 | 0x69 | i | LATIN SMALL LETTER I |

Supported character set (Continued)

| ASCII Code | GSM 03.38 Code | ASCII Character | Description |
|------------|----------------|-----------------|----------------------|
| 0x6A | 0x6A | j | LATIN SMALL LETTER J |
| 0x6B | 0x6B | k | LATIN SMALL LETTER K |
| 0x6C | 0x6C | l | LATIN SMALL LETTER L |
| 0x6D | 0x6D | m | LATIN SMALL LETTER M |
| 0x6E | 0x6E | n | LATIN SMALL LETTER N |
| 0x6F | 0x6F | o | LATIN SMALL LETTER O |
| 0x70 | 0x70 | p | LATIN SMALL LETTER P |
| 0x71 | 0x71 | q | LATIN SMALL LETTER Q |
| 0x72 | 0x72 | r | LATIN SMALL LETTER R |
| 0x73 | 0x73 | s | LATIN SMALL LETTER S |
| 0x74 | 0x74 | t | LATIN SMALL LETTER T |
| 0x75 | 0x75 | u | LATIN SMALL LETTER U |
| 0x76 | 0x76 | v | LATIN SMALL LETTER V |
| 0x77 | 0x77 | w | LATIN SMALL LETTER W |
| 0x78 | 0x78 | x | LATIN SMALL LETTER X |
| 0x79 | 0x79 | y | LATIN SMALL LETTER Y |
| 0x7A | 0x20 | z | LATIN SMALL LETTER Z |
| 0x7B | 0x1B28 | { | LEFT CURLY BRACKET |
| 0x7C | 0x1B40 | | VERTICAL LINE (PIPE) |
| 0x7D | 0x1B29 | } | RIGHT CURLY BRACKET |
| 0x7E | 0x1B3D | ~ | TILDE |
| 0x7F | 0x20 * | DEL | DELETE |

XBee network settings

A Digi ConnectPort X gateway provides a gateway between an Internet Protocol (IP) network and a network of various wireless devices containing XBee RF modules. Typically, these XBee devices are small sensors and controllers.

The XBee Configuration settings (**Configuration > XBee Network**) displays a view of XBee network devices, including the ConnectPort X gateway and any nodes that have been discovered by the XBee module in the ConnectPort X gateway. For example:

XBee Configuration

▼ Network View of the XBee Devices

| Node ID | Network Address | Extended Address | Node Type | Product Type |
|---------|--------------------------|--------------------------|-------------|--------------|
| [0000]! | 00:13:a2:00:40:0a:09:15! | 00:13:a2:00:40:0a:09:15! | coordinator | X4 Gateway |
| [26f9]! | 00:13:a2:00:40:34:12:f1! | 00:13:a2:00:40:34:12:f1! | router | Unspecified |
| [78b2]! | 00:13:a2:00:40:4a:b9:c8! | 00:13:a2:00:40:4a:b9:c8! | end node | |

Clear list before performing refresh

Refresh

▶ Firmware Update

In the **Node Type** column, the descriptors for the nodes can vary by the RF protocol running in the XBee module in the gateway and in any nodes.

For example, XBee ZB series products show the XBee module in the gateway as the **coordinator**, and any XBee Drop-in Networking Accessories are as **routers**.

Network View of the XBee Devices

| Node ID | Network Address | Extended Address | Node Type | Product Type |
|---------|--------------------------|--------------------------|-------------|--------------|
| [0000]! | 00:13:a2:00:40:52:92:26! | 00:13:a2:00:40:52:92:26! | coordinator | X4 Gateway |
| [10a2]! | 00:13:a2:00:40:3e:07:68! | 00:13:a2:00:40:3e:07:68! | router | Unspecified |

Clear list before device discovery

Discover XBee Devices

XBee 802.15.4 series products show the XBee module in the gateway as the **coordinator**, and any XBee Drop-in Networking Accessories as **end nodes**.

Network View of the XBee Devices

| Node ID | Network Address | Extended Address | Node Type | Product Type |
|---------|-----------------|--------------------------|-------------|--------------|
| [0000]! | [0000]! | 00:13:a2:00:40:30:fb:32! | coordinator | X4 Gateway |
| [0000]! | [0000]! | 00:13:a2:00:40:53:6d:f8! | end node | |

Clear list before device discovery

Discover XBee Devices

Clicking on the **Network Address** or **Extended Address** of a node displays the XBee Network Configuration settings for the XBee RF module in the ConnectPort X gateway. The configuration settings include basic and advanced settings for the XBee radio module. The settings displayed vary depending on the XBee RF protocol running in the XBee modules. The settings shown here are for an XBee ZB module.

XBee Configuration

Extended Address: 00:13:a2:00:40:3e:07:68!
Product Type: Unspecified
Firmware Version: 0x2242

Basic Settings

Basic Radio Settings

Extended PAN ID (ID): 8 hex bytes (Setting to 0 allows a random exte
Note: Changing the PAN I

Node Identifier (NI):

Discover Timeout (NT): tenths of second (0-252)

Scan Channels (SC): hex (0xffff=all channels)

Scan Duration (SD): (0-7)

Advanced Radio Settings

Transmit Power Level (PL):

Allows Join Time (NJ): seconds (0-64, 255=always)

Broadcast Hops (BH): (0-7, 0=disabled)

RSSI PWM (P0): Enable RSSI PWM

RSSI Timer (RP): msec (0-255, 255=always on)

Associate LED (D5):

Serial Interface Settings

Baud Rate (BD):

Parity (NB):

Flow Control (D7): Enable CTS Flow Control (DIO7)

Packetization Timeout (RO): msec (0-255, 255=immediate)

Advanced Settings

Basic and Advanced radio settings

The **Basic radio settings** control basic operation of the XBee module in an XBee network.

Advanced radio settings control behavior of the XBee module at a more detailed level. Generally, these settings can be left at their defaults.

For complete settings and descriptions of these options, refer to the Product Manual for the XBee or XBee-PRO RF module in your product.

View and change configuration settings as needed. To apply configuration changes, click **Apply**.

Note



- Changing the PAN ID may make your XBee product inaccessible.
- If you assign a Node Identifier, to view it, go to **Configuration > XBee Network** and click **Refresh**. The new name is displayed in the **Node Identifier** field.

Firmware updates for XBee modules

XBee RF modules can be updated with new firmware over the XBee network. Firmware updates can be made both to the XBee RF module in the Digi device serving as a gateway to the XBee network, and to the XBee RF modules in other XBee network nodes.

Firmware updates for the ConnectPort X gateway's XBee module are available through Digi Technical Support. Once loaded onto a PC, firmware updates can be loaded into the XBee module by several methods:

- In the web interface for the ConnectPort X gateway, by clicking the **Firmware Update Setup** link on the **XBee Network Configuration** page and uploading files containing the new firmware. Multiple files may be uploaded, each containing a different firmware type.
- Firmware updates of network nodes can be scheduled and monitored on the **Firmware Update Status** page.
- Through the command line interface, using several options on the **set xbee** command.

Note XBee firmware can also be updated by sending over-the-air (OTA) commands to the XBee module through the OTA graphical user interface of X-CTU, a software tool for configuring XBee modules. In X-CTU, the OTA interface is called **Remote Configuration**. However, the **Enable over the air firmware updates** setting on the **Firmware Update Setup** page enables remote firmware updates without having to use X-CTU.

XBee Firmware requirements

The XBee firmware version must be compatible with the XBee module's hardware and the ConnectPort X gateway firmware.

The XBee firmware must also be over-the-air compatible with other nodes. Generally, this means that the gateway and nodes must be the same network type (ZB, 802.15.4, etc.) and have the same or similar firmware version.

XBee firmware file-naming conventions

The file-naming convention for numbering XBee firmware versions is

HW_XYZZ.EXT

where:

HW = module hardware and network type; that is, the XBee RF protocol running on the module

X = a number specifying the network type

XYZZ is the full version number in hexadecimal.

Y = node type

ZZ = revision number

EXT = extension, designating the file type

HW values-Hardware type

Each XBee module hardware series has the same hardware, but uses different firmware for the XBee RF protocol running on the module.

| XBee Module hardware series | XBee RF protocol | <i>HW</i> value in firmware filename |
|---|--------------------------|---|
| XBee 802.15.4 and Digi Mesh 2.4standard modules | 802.15.4 | XB24_15_4 |
| | DigiMesh 2.4GHz | XB24-DM |
| XBee-PRO 802.15.4 and Digi Mesh 2 modules | 802.15.4 | XBP24_15_4 |
| | DigiMesh 2.4GHz | XBP24-DM |
| XBee ZB and Smart Energy standard modules | ZB | XB24-ZB |
| | Smart Energy | XB24-SE |
| XBee-PRO ZB and Smart Energy standard modules | ZB | XBP24-ZB |
| | Smart Energy | XBP24-SE |
| XBee DigiMesh 900MHz series modules | XBee PRO 900MH | XBP09-DP |
| | XBee PRO DigiMesh 900MHz | XBP09-DM |
| XBee DigiMesh 868MHz series radios: | XBee PRO 868MHz | XBP08-DP |

X values-Network type

| Network type | X value |
|----------------------------------|----------------|
| XBee 802.15.4, 868MHz, or 900MHz | 1 |
| XBee ZB | 2 |
| Smart Energy | 3 |
| DigiMesh | 8 |

Y value-Node type

| Node type | Y value |
|---|---------|
| Standard node, or Coordinator AT command mode | 0 |
| Coordinator API mode | 1 |
| Router AT mode | 2 |
| Router API mode | 3 |
| Router/End Device Sensor Adapter | 4 |
| End Device Power Harvester Adapter | 5 |
| Router/End Device Analog IO Adapter | 6 |
| Router/End Device Digital IO Adapter | 7 |
| End Device AT command mode | 8 |
| End Device API mode | 9 |
| Multiple node types in a zip file | x |

API mode is a frame-based interface mode that extends the level to which a host application can interact with the networking capabilities of the module. When in API mode, all data entering and leaving the module is contained in frames that define operations or events within the module. Gateways typically use XBee firmware for coordinator API mode. More information about API mode is in the Product Manuals for the XBee RF modules.

AT mode is a state in which incoming serial characters are interpreted as XBee AT commands. More information about AT mode is in the Product Manuals for the XBee RF modules.

XBee ZB and Smart Energy standard networks have all node types.

Other network types have standard nodes and adapters.

ZigBee nodes use different firmware for AT and API mode.

Standard nodes support both AT and API modes.

The gateway XBee module must be ZigBee type 1 or 3, or non-ZigBee type 0.

Remote nodes may be any node type.

EXT values-File extensions

| Extension | File type |
|------------------|--|
| ebl | XBee ZB and Smart Energy standard module firmware |
| oem | XBee module firmware for all other XBee module types |
| hex | Hexadecimal-encoded firmware |
| ehx | Encrypted hexadecimal firmware |
| mxi | XBee module parameter information |
| zip | Archive of above files |

The XBee module in a Digi gateway device can be updated with .ebl or .oem files.

XBee ZB remote nodes can be updated over the air with ebl files.

X-CTU uses .hex, .ehx, .mxi, and .zip files.

X-CTU can create .oem files from .ehx files.

For example: XBP24-ZB_2164.ebl is XBee PRO ZB coordinator API firmware that can be used to update the gateway XBee module.

XBee firmware versions supported in ConnectPort X gateways

Currently, ConnectPort X gateways support these XBee firmware versions:

| XBee module model type in gateway | Supported firmware versions |
|--|------------------------------------|
| XBee ZB | Version 2x21 or greater |
| XBee 802.15.4 | Version 1080 or greater |
| XBee DigiMesh 900 MHz | Any firmware version |
| XBee DigiMesh 2.4 | Version 8040 or greater |
| XBee Smart Energy (SE) | Any firmware version |
| XBee DigiMesh 868 MHz | Any firmware version |

Settings preserved during firmware updates

If the gateway is enabled, most XBee module settings will be preserved during the firmware update. Some settings, such as encryption keys, may not be preserved and must be entered again.

Note The gateway can be disabled by the `set xbee state=off` command. It will also be disabled if it cannot communicate with its XBee module. The most likely cause of this state is unsupported firmware on the XBee module. The XBee module's firmware can still be updated when the gateway is disabled.

Update XBee firmware rom the web interface--for ConnectPort X ZB gateways only

To update XBee firmware for a ConnectPort X gateway with a XBee ZB module:

- 1 On the Digi gateway, upload files containing the new firmware on the **Configuration > XBee Network > Firmware Update Setup** page. Multiple files may be uploaded, each containing a different firmware type needed by nodes on the network.
- 2 Schedule and monitor updates of individual nodes on the **Firmware Update Status** page. Each scheduled update will be performed in the background, one node at a time. While a remote node is being updated, it will be inaccessible from the XBee network. While the XBee module in the gateway is being updated, the XBee network will inaccessible from the gateway.

Firmware Update Setup page

Several groups of settings on this page control how XBee firmware updates are performed:

- **Update Settings** section
 - **Enable over the air firmware updates:** Enable updates of firmware on remote nodes over the XBee network. Firmware updates use a background process to query remote nodes for their current firmware version, and update their firmware from files stored on the gateway. This process may be disabled to suspend firmware updates, or if the update process interferes with applications using the network.
 - **Automatically update nodes to the latest firmware version:** When a node reports its firmware version, and a newer version of firmware is available on the gateway, schedule a firmware update without user action. This option can be used to automatically update nodes as they join the network. If this option is not selected, firmware updates can be manually scheduled from the **Firmware Update Status** page.
 - **Stop automatic updates if an update error occurs:** If an error occurs while updating a node, suspend further updates of other nodes. Updates can be resumed by clicking **Apply** on this page.
- **Upload Files** section: This section of the page is used to upload XBee firmware files to the gateway. These files contain the firmware image used to update nodes on the XBee network. Multiple files may be uploaded, each containing a different firmware type and version. Firmware files must end with an .ebl extension.
Click **Browse** to select a firmware file and then click **Upload**.
- **Manage Files** section: This section of the page lists all firmware files that have been uploaded to the Digi device, along with their type and version number.
After all nodes have been updated, these files can be removed from the gateway. Select any files you would like to remove and click **Delete**.

Firmware Update Status page

This page lists all nodes on the XBee network, along with their current firmware update status.

Select one or more nodes to be updated by checking the box to the left of the nodes.

To select a range of nodes, click on the starting check box, then hold down the Shift key and click on the ending check box.

Click on a value in the table to select all nodes with that value. For example, click on a firmware version to select all nodes with the same version.

These fields are shown in the table:

- **Check box:** Check this box to select the node for a firmware update.
- **Node ID:** The user assigned identifier of the node.
- **Extended Address:** The unique 64-bit MAC address of the node.
- **HW:** The hardware type and version of the node. **XB**P indicates that the node is an XBee-PRO module.
- **FW:** The current firmware version of the node.
- **Status:** The firmware update status of the node. It may be one of these values:
 - **Unknown:** The current firmware version has not yet been read from the node, or cannot be read from the node.
 - **Up to date:** The node is running the latest firmware version available on the gateway.
 - **Available:** A newer version of firmware is available on the gateway. Select the node and click Update to schedule an update.
 - **Scheduled:** A firmware update is scheduled to be performed on this node.
 - **Updating:** A firmware update is now being performed on this node.
 - **Updated:** A successful firmware update has been performed on this node.
 - **Complete:** The node has rejoined the network after a successful firmware update.
 - **Cancelled:** A firmware update for this node has been cancelled by the user. Select the node and click **Update** to restart the update.
 - **Error:** A firmware update on this node has failed. Select the node and click Update to retry the update.
- **Update File:** The firmware file used to update the node.
- **Refresh:** Display the latest firmware update status.
- **Update selected nodes with firmware file:** To use the file listed in the table for each node, choose **Update File**. To use a different file, choose a firmware file from the list. Firmware files are uploaded on the **Firmware Update Setup** page.
- **Use this router node as the updater:** The updater node is a router within radio range of the node being updated. The updater sends the firmware image directly to the node during the update process. Choose **Automatic** to use the best available updater node. Choose a router from the list to use a specific updater node.
- **Update:** Schedule a firmware update of the selected nodes.
- **Cancel Update:** Cancel a scheduled firmware update of the selected nodes.

Update XBee firmware via the web interface--all other ConnectPort X gateways

For ConnectPort X gateways that have any other XBee module type than ZB, the process for updating firmware is as follows:

- 1 In the web interface, go to **Configuration > XBee Network > XBee Configuration**. On the XBee Configuration page, click the **Firmware Update** link.

The **Firmware Update** page shows the type of XBee radio in the gateway and the current firmware level.

- 2 Enter or browse to the file name containing the firmware update for the XBee module.

For all ConnectPort X gateways besides ZB models, the firmware files have the extension **.oem**. Files ending with **.zip** or **.ehx** cannot be used on this page.

- 3 Click the **Update** button.

After the firmware is loaded successfully, the XBee module will be restarted.

Updating XBee firmware via the command line interface

The **set xbee** command has several options for performing XBee firmware updates. See the **set xbee** command description in the Connect Family Command Reference.

Additional information on XBee modules and networks

The XBee Network page in System Information

(**Administration > System Information > XBee Network**)

displays more detailed information about XBee network devices, including counters related to any applications that are exercising the devices. See "Views and statistics for managing XBee networks" on page 197.

For detailed information about XBee module settings and operation, see the Product Manual for the XBee RF module, available from Digi's Support site.

Serial port settings

Use the Serial Port Configuration page to establish a port profile for the serial port of the Digi device. The Serial Port Configuration page includes the currently selected port profile for the serial port, detailed configuration settings for the serial port, dependent on the port profile selected, and links to basic and advanced serial settings.

About port profiles

Port profiles simplify serial port configuration by displaying only those items that are relevant to the currently selected profile. If the Digi Device Setup Wizard was used to initially configure the Digi device, the wizard prompted to select a port profile.

There are several port profile choices, but not all port profiles are supported in all products. Support of port profiles varies by Digi product. If a profile listed in this description is not available on the page, it is not supported in the Digi product.

If a port profile has already been selected, it is shown at the top of the screen. The profile can be changed, or retained but individual settings adjusted.

Everything displayed on the Serial Port Configuration screen between **Port Profile Settings** and the links to the **Basic Serial Settings** and **Advanced Serial Settings** depends on the port profile selected.

Select and configure a port profile

- 1 To configure any profile select **Serial Ports**.
- 2 Click the port to be configured.
- 3 Click **Change Profile**.
- 4 Select the appropriate profile and Click **Apply**.
- 5 Enter the appropriate parameters for each profile. Descriptions of each profile follow. See also the online help for the configuration screens for more details about settings and values.
- 6 Click **Apply** to save the settings.

RealPort profile

The RealPort profile maps a COM or TTY port to a serial port. This profile configures a Digi device to create a virtual COM port on a PC, known as COM Port Redirection. The PC applications send data to this virtual COM port and RealPort sends the data across the network to the Digi device.

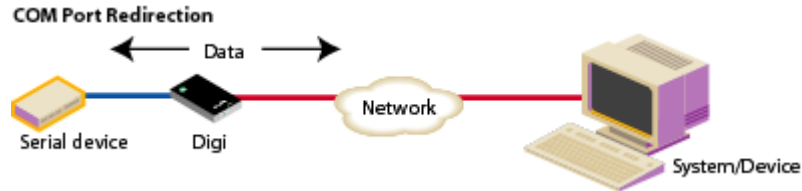

Data is routed to the serial device connected to the Digi device's serial port. The network is transparent to both the application and the serial device.

Important: On each PC that will use RealPort ports, RealPort software must be installed from the Software and Documentation CD, if provided with the Digi device, or the Digi Support site, and configured. Installation instructions are on page 173. Enter the IP address of the Digi device and the RealPort TCP port number 771.

Console Management profile

The Console Management profile allows access to a device's console port over a network connection. Most network devices such as routers, switches, and servers offer one or more serial ports for management. Instead of connecting a terminal to the console port, cable the console port to the serial port of the Digi device. Then using Telnet features, network administrators can access these consoled serial ports from the LAN by addressing the appropriate TCP port.

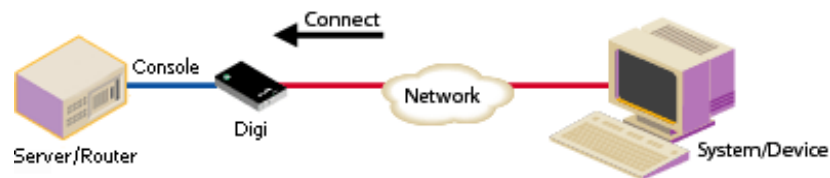

TCP Sockets profile

The TCP Sockets profile allows serial devices to communicate over a TCP network. The TCP Server allows other network devices to initiate a TCP connection to the serial device attached to the serial port of the Digi device.

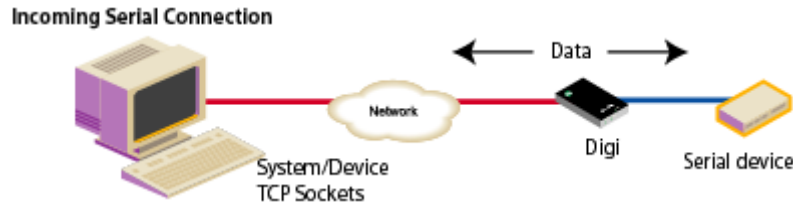

Automatic TCP connections (autoconnection)

The TCP Client allows the Digi device to automatically establish a TCP connection to an application or a network, known as autoconnection. Autoconnection is enabled through the TCP Sockets profile's setting labeled **Automatically establish TCP connections**.

Note When the TCP Sockets profile is set, the DTR flow-control signal indicates when a TCP socket connection has been established. This information can be useful in monitoring the serial line and using it as a flow-control mechanism to determine when the Digi device is connected to a remote device with which communication is being established. This mechanism can be combined with using the DCD signal to close the connection and the DSR signal to do RCI over serial. Together, these signals can be used to make the Digi device auto connect to many devices, deterministically, on the network.

RFC 2217 support

Digi devices support RFC 2217, an extension of the Telnet protocol used to access serial devices over the network. RFC 2217 implementations enable applications to set the parameters of remote serial ports (baud rate, flow control, etc.), detect line signal changes, as well as receive and transmit data. The configuration information provided in this section applies to Digi device functioning as RFC 2217 servers.

If using the RFC 2217 protocol, do not modify the port settings from the defaults. If the port settings have been changed, restore the factory default settings (see "Restore a device configuration to factory defaults" on page 217). No additional configuration is required.

TCP and UDP network port numbering conventions

Digi devices use these conventions for TCP and UDP network port numbering.

| For this connection type... | Use this Port |
|-----------------------------------|-------------------|
| Telnet to the serial port | 2001 (TCP only) |
| Raw connection to the serial port | 2101(TCP and UDP) |

Ensure that the application or Digi device that initiates communication with the uses these network ports numbers. If they cannot be configured to use these network port numbers, change the network port on the Digi device.

UDP Sockets profile

The UDP Sockets profile allows serial devices to communicate using UDP. The UDP Server configuration allows the serial port to receive data from one or more systems or devices on the network. The UDP Client configuration allows the automatic distribution of serial data from one host to many devices at the same time using UDP sockets.

The port numbering conventions shown in the TCP Sockets Profile also apply to UDP sockets.

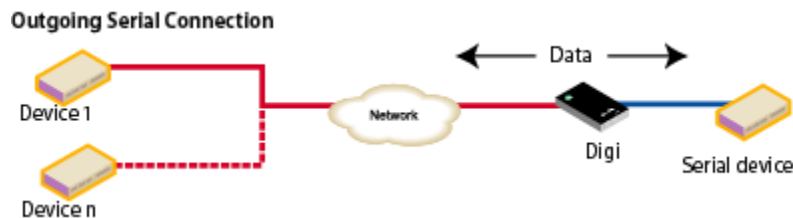

Serial Bridge profile

The Serial Bridge profile configures one side of a *serial bridge*. A serial bridge connects two serial devices over the network, each of which uses a Digi device, as if they were connected with a serial cable. The serial devices “think” they are communicating with each other across a serial cable using serial communication techniques. There is no need to reconfigure the server or the serial device. Neither is aware of the intervening network. Serial bridging is also known as *serial tunneling*.

This profile configures each side of the bridge separately. Repeat the configuration for the second Digi device of the bridge, specifying the IP address of the first Digi device.



Local Configuration profile

The Local Configuration profile allows for connecting standard terminals or terminal emulation programs to the serial port in order to use the serial port as a console to access the command line interface. Profile settings enable and disable access to the command line.

Modem Emulation profile

The Modem Emulation profile allows a Digi device to send and receive modem responses to the serial device over the Ethernet instead of PSTN (Public Switched Telephone Network). This profile allows maintaining the current software application but using it over a less-expensive Ethernet network.



The commands that can be issued in a modem-emulation configuration are described in the *Digi Connect Family Command Reference*.

Industrial Automation profile

This port profile is available in Digi devices that support Industrial Automation (IA) and the Modbus protocol. It has serial port settings appropriate for the Digi Connect WAN IA's use in IA applications. It allows you to control and monitor various IA devices and PLCs. Serial ports for Digi Connect WAN IA devices are set to use this port profile by default. The default settings for the Digi Connect WAN IA and in this port profile should be sufficient for most IA applications. If you need to change the settings from the defaults, use the "set ia" command, documented in the *Digi Connect Family Command Reference*.

GPS Profile

The GPS profile allows the Digi device to make use of an NMEA-0183 compliant GPS data stream for location and geofencing.

Custom Profile

The Custom port profile displays all serial-port settings, which can be changed as needed. Use the Custom profile only if the use of the serial port does not fit into any of the predefined port profiles, for example, if network connections involve a mix of TCP and UDP sockets.



Basic serial settings

After selecting a port profile, the profile settings are displayed. Choose the appropriate features for your environment. Here are brief descriptions of the fields in the Basic Serial Settings; see the online help for detailed information about each setting.

- The **Description** field specifies an optional character string for the port which can be used to identify the device connected to the port.
- **Basic Serial Settings** include **Baud Rate**, **Data Bits**, **Parity**, **Stop Bits**, and **Flow Control**. The basic serial port settings must match the serial settings of the connected device. If you do not know these settings, consult the documentation that came with your serial device. These serial settings may be documented as 9600 8N1, which means that the device is using a baud rate of 9600 bits per second, 8 data bits, no parity, and 1 stop bit.

When using RealPort (COM port redirection) or RFC 2217, these settings are supplied by applications running on the PC or server, and the default values on the Digi device do not need to be changed.

Advanced serial settings

The advanced serial settings further define the serial interface, including whether port buffering (also known as port logging), RTS Toggle, and RCI over Serial are enabled as general serial interface options. You can also define how specific aspects of TCP and UDP serial communications should operate, including timeouts and whether a socket ID is sent.

Serial Settings

The **Serial Settings** part of the page includes these options:

- **Enable Port Logging:** Enables the port-buffering feature, which allows you to monitor incoming ASCII serial data in log form. The Log Size field specifies the size of the buffer that contains the log of ASCII serial data.
- **Enable RTS Toggle:** When enabled, the RTS (Request To Send) signal is forced high (on) when sending data on the serial port.
- **Enable RCI over Serial (DSR):** This choice allows the Digi Connect device to be configured through the serial port using the RCI protocol. See the RCI specification in the Digi Connect Integration Kit for further details.

RCI over Serial uses the DSR (Data Set Ready) serial signal. Verify that the serial port is not configured for autoconnect, modem emulation, or any other application which is dependent on DSR state changes.

TCP settings

The **TCP Settings** are displayed only when the current serial port is configured with the TCP Sockets or the Custom Profile. The settings are as follows:

- **Send Socket ID:** Include an optional identifier string with the data sent over the network. The Socket ID can be 1 to 256 ASCII characters. To enter non-printable characters, use these key sequences:

| Character | Key Sequence |
|--------------------|--------------|
| backspace | \b |
| formfeed | \f |
| tab | \t |
| new line | \n |
| return | \r |
| backslash | \\ |
| hexadecimal values | \xhh |

- **Send data only under any of the following conditions:** Enable if it is required to set conditions on whether the Digi device sends the data read from the serial port to the TCP destination. Conditions include:
 - **Send when data is present on the serial line:** Send the data to the network destinations when a specific string of characters is detected in the serial data. Enter the string 1 to 4 characters in the Match String field. To enter non-printable characters, use these key sequences:

| Character | Key Sequence |
|--------------------|--------------|
| hexadecimal values | \xhh |
| tab | \t |
| line feed | \n |
| backslash | \\ |

- **Strip match string before sending:** Match string before sending to strip the string from the data before it is sent to the destination.
- **Send after the following number of idle:** Send the data after the specified number of milliseconds has passed with no additional data received on the serial port. This can be 1 to 65,535 milliseconds.
- **Send after the following number of bytes:** Send the data after the specified number of bytes has been received on the serial port. This can be 1 to 65,535 bytes.

- **Close connection after the following number of idle seconds:** Enable to close an idle connection. Use the Timeout field to enter the number of seconds that the connection will be idle before it is closed. This can be 1 to 65000 seconds.
- **Close connection when DCD goes low:** When selected, the connection will be closed when the DCD (Data Carrier Detected) signal goes low.
- **Close connection when DSR goes low:** When selected, the connection will be closed when the DSR (Data Set Ready) signal goes low.

UDP settings

The UDP Settings are displayed only when the current serial port is configured with the UDP Sockets or the Custom Profile.

- **Send Socket ID:** Include an optional identifier string with the data sent over the network. The Socket ID can be 1 to 256 ASCII characters. To enter non-printable characters, use these key sequences:

| Character | Key Sequence |
|--------------------|--------------|
| backspace | \b |
| formfeed | \f |
| tab | \t |
| new line | \n |
| return | \r |
| backslash | \\ |
| hexadecimal values | \xhh |

Display current serial port settings

To display the current serial port settings for a Digi device, enter the **display techsupport** command from the command line interface.

Camera settings

ConnectPort X Family products support connecting a WatchPort® Camera to one of its USB host ports. One Digi WatchPort V2 USB camera is supported.

Camera settings

These settings configure the camera operation and handling of images captured by the camera.

- **Enable Camera:** Enables and disables camera. When disabled, all camera activity stops and all used memory is freed.
- **Resolution:** The resolution level for images.
- **Frame Delay:** The minimum time between frames in milliseconds. The actual delay time between frames will be this number or greater. The camera automatically increases this value as needed, such as in low light conditions. This delay time is the inverse of frames per second. For instance, if you wish to set the camera to process at a maximum of 5 frames per second, the frame delay is set to 200 ($1/5 = 0.2$ second = 200 ms).
- **Quality:** Image quality. Choose a quality from 0 to 100; with 0 being the lowest quality and smallest image sizes and 100 being the best image quality but largest image size. Qualities ranging from 30 to 80 are recommended. Quality above 80 results in much larger images than lower qualities, which result in lower overall performance and increased memory use.
- **Send Images to TCP Server:** Enables sending camera images to a TCP server. The TCP server application must conform to the protocol sent by this device, which is: on connect, the TCP client sends a protocol id of four bytes: 0x85ce4a71, followed by a protocol version of 4 bytes: 0x00000010. After this, images are sent repeatedly in the form of 4 bytes containing the length of the JPEG image to follow, and the JPEG image.
 - **TCP Server:** Name of the server to receive image data.
 - **TCP Port:** TCP port. The default port is 22222.
- **Current Image:** Displays a snapshot of the current camera image. Clicking on the image displays a new window with the full-size image (as configured above). If **No Camera Available** is displayed, the camera is disabled (see above), no camera is attached to the device, or some other problem is causing the camera to work incorrectly. This current snapshot can be accessed by any web browser directly by using the URL: <http://device-ip/FS/dev/camera/0>
- **Advanced Settings:** All settings from **Automatic Gain Control** on are advanced camera settings. Leaving these camera settings at their defaults is recommended. Advanced users can modify them as needed, but most users do not need to modify them.

Camera operation

Once the camera is connected and configured, the current snapshot image from the camera is available directly from the device at the following URL:

<http://device-ip/FS/dev/camera/0>

Video from the camera is available by streaming the camera data to a TCP server application, a configured by the **Send Images to TCP Server** configuration settings. For more information, see the Installation Guide for your Watchport Camera.

Alarms

The **Alarms** page is for configuring device alarms and displaying alarm settings. Device alarms are used to send email messages or SNMP traps when certain device events occur. These events include certain data patterns being detected in the data stream, alarms for signal strength and amount of cellular traffic for a given period of time.

Alarm notification settings

On the Alarms page, the Alarm Notification Settings control the following:

- **Enable alarm notifications:** Enables or disables all alarm processing for the Digi Connect device.
- **Send all alarms to the Remote Management server:** enables or disables sending of alarm notifications to a server that handles remote management of devices, such as the iDigi Platform.

Enabling this setting sends all alarm notifications to a remote management server. Enable this option if the Digi device is managed by a remote management server, such as the iDigi Platform. Enabling this option is useful because it allows all alarms to be monitored from one location. Enabling this option also allows Digi devices to send alarms to clients that would otherwise be unreachable from the Digi device, either because the Digi device is behind a firewall or not on the same network as the alarm destination.

Disabling this settings disables sending of alarm notifications to a remote management server. Disable this option if devices are not managed by a remote management server or if alarms should be sent from the device, for example, because an SNMP trap destination is local to the device, not the iDigi Platform server.

- **Mail Server Address (SMTP):** Specifies the IP address of the SMTP mail server. Ask your network administrator for this IP address.
- **From:** Specifies the text that will be used in the “From:” field for all alarms that are sent as emails.

Alarm conditions

The **Alarm Conditions** part of the Alarms page shows a list of all of the alarms. Up to 32 alarms can be configured for a Digi device, and they can be enabled and disabled individually.

Alarm list and status

The alarm list displays the current status of each alarm. This list can be used to list to view alarm status at a glance, then view more details for each alarm as needed.

- **Enable:** Checkbox indicates whether the alarm is currently enabled or disabled.
- **Alarm:** The number of the alarm.
- **Status:** The current status of the alarm, which is either enabled or disabled.
- **Type:** The basis for the alarm.
- **Trigger:** The conditions that trigger the alarm.
- **SNMP Trap:** Indicates whether the alarm is sent as an SNMP trap.
 - If the **SNMP Trap** field is disabled, and the **Send To** field has a value, the alarm is sent as an email message only.
 - If the **SNMP Trap** field is enabled and the **Send To** field is blank, the alarm is sent as an SNMP trap only.
 - If the **SNMP Trap** field is enabled, and a value is specified in the **Send To** field, that means the alarm is sent both as an email and as an SNMP trap.
- **Send To:** The email address to which the alarm is sent.
- **Email Subject:** Text to include in the **Subject** line of alarms sent as email messages.

Alarm configuration

To configure an alarm, click on it. The configuration page for individual alarms has two sections.

Alarm conditions

For specifying the conditions on which the alarm is based, serial data pattern matching, signal strength (RSSI), or data usage. Alarm conditions include:

- **Send alarms based on serial data pattern matching:** Click this radio button to specify that this alarm is sent when the specified serial data pattern is detected. Then specify the following:
 - **Serial Port:** The serial port to monitor for the data pattern. This field is displayed for devices where more than one serial port is available.
 - **Pattern:** An alarm is sent when the serial port receives this data pattern. Special characters such as carriage return carriage return (\r) and new line (\n) in the data pattern can be included.
- **Send alarms based on average RSSI level below threshold for amount of time:** Send alarms based on the average signal strength falling below a specified threshold for a specified amount of time.
 - **RSSI:** The threshold signal strength, measured in dB (typically -120 dB to -40 dB).
 - **Time:** The amount of time, in minutes, that the signal strength falls below the threshold.

Note The **set alarms** command has an option, **optimal_alarms_enabled={yes|no}**. If enabled, this option causes an optimal alarm to be sent when the signal strength returns to a value that is above the specified threshold. This feature is only available through the command line. The default for this option is **no**; it must be explicitly enabled if desired.
- **Send alarms based on cellular data exchanged in an amount of time:**
 - **Data:** The number of bytes of cellular data.
 - **Time:** The number of minutes.
 - **Cell Data Type:** The type of cellular data exchanged: Receive data, Transmit data, or Total data.

Alarm destinations

The Alarm Destination part of the page defines how alarm notifications are sent, either as an email message or an SNMP trap, or both, and where the alarm notification is sent.

- **Send E-mail to the following recipients when alarm occurs:** Select the checkbox to specify that the alarm should be sent as an email message. Then specify the following information:
 - **To:** The email address to which this alarm notification email message will be sent.
 - **CC:** The email address to which a copy of this alarm notification email message will be sent (optional).
 - **Priority:** The priority of the alarm notification email message.
 - **Subject:** The text to be included in the Subject: line of the alarm-notification email message.
- **Send SNMP trap to the following destination when alarm occurs:** Select the checkbox to specify that the alarm should be sent as an SNMP trap.
 For alarms to be sent as SNMP traps, the IP address of the destination for the SNMP traps must be specified in the SNMP settings. This is done on the System Configuration pages of the web interface. See "Simple Network Management Protocol (SNMP)" on page 158. That destination IP address is then displayed below the "Send alarm to SNMP destination" checkbox. A secondary or backup SNMP destination can be specified.
- To configure an alarm notification to be sent as both an email message and an SNMP trap, select both **Send E-Mail** and **Send SNMP trap** checkboxes.
- Click **Apply** to apply changes for the alarm and return to the Alarms Configuration page.

Enable and Disable Alarms

Once alarm conditions are configured, enable and disable individual alarms by selecting or deselecting the Enable checkbox for each alarm.

System settings

The System Configuration page configures device identity and description information, date and time settings, and settings for Simple Network Management Protocol (SNMP).

Device identity settings

The device identity settings create a description of the Digi device's name, contact, and location. This information can be useful for identifying a specific Digi device when working with a large number of devices in multiple locations.

- **Description:** The network name assigned to the Digi device.
- **Contact:** The SNMP contact person (often the network administrator).
- **Location:** A text description of the physical location of the Digi device.
- **Device ID:** The device ID assigned to this device that corresponds to the device ID used by the Connectware server. This option only applies when the Connectware server is being used to configure and manage the device.

Date and Time settings

The Date and Time settings set the Coordinated Universal Time (UTC) and/or system time and date on a device, or sets the offset from UTC for the device's system time.

Set Date and Time

Click the **Set** button to configure the hours, minutes, seconds, month, day, and year on the device.

If offset is set to 00:00, the device's system time and UTC are the same. Setting time and date with an offset of 00:00 results in both UTC and system time being set to the specified value.

If offset is not 00:00, setting time sets the system time to the specified value and UTC is adjusted accordingly.

Offset from UTC

Specifies the offset from UTC for this device. Offset can range from -12 hours to 14 hours. Very rarely, a time zone can also have an offset in minutes (15, 30, or 45).

This value can be used to modify the time and date (generally expected to be UTC) to compensate for time zones and daylight savings time.

Wikipedia provides a list of time zone offsets at:

http://en.wikipedia.org/wiki/List_of_time_zones

On a device with no real-time clock (RTC) and no configured time source, time and date are completely local to the device and have limited usefulness since they are not persistent over reboots/power-cycles.

On a device with an RTC and no configured clock source, time and date are also local to the device but they are meaningful because they are persistent. The offset option could be useful in adjusting for daylight savings time. Setting the date and time to standard time and setting offset to 1 whenever daylight savings time is in effect would serve that purpose.

On a device with a configured clock source, time and date received from a clock source is expected to be UTC. For users with several devices in different time zones, keeping offset=00:00 might be useful for comparing logs or traces from different devices, since all would be using UTC.

Time Source Settings

The time source settings configure access to up to five external time sources that can be used to set and maintain time on the device.

- **Type:** Specifies the type of time source for this entry.
 - **sntp server:** The device uses its SNTP client to poll the NTP/SNTP server, specified by the FQDN, for time.
 - **cellular:** The device polls the cellular service for time.
- **Interval:** Specifies the interval in seconds between polls of a time source. Interval can range from 1 second to 31536000 seconds. If more than one time source is specified, time sources with shorter intervals have greater influence on the device's time than do sources with longer intervals.
- **FQDN:** Specifies the fully-qualified domain name or IP address for the time source. The FQDN is used only if the time source is SNTP.

The only time source that is guaranteed to be present on all products at all times is the system clock. It counts uptime and displays system time as the UNIX Epoch (00:00:00 on January 1, 1970) plus uptime. Any source that is not the system clock is considered an external source. This includes the RTC.

Devices which have an RTC but have no external time sources configured will display system time as the UNIX Epoch plus the time since power was initially applied to the device until system time is set manually. System time can be set manually via the CLI, Web UI, etc. Once system time is set manually, the RTC will continue to maintain system time but, due to variations in the accuracy of the RTC, system time can diverge from external time.

Specifying an external time source allows the device to compare its system time to the time reported by the configured time sources and make appropriate adjustments to system time. This allows system time to stay consistent over long durations.

The polling interval for an external source establishes its priority relative to other sources; the more samples taken from a time source, the greater influence that time source has on system time.

Any time adjustment will update the RTC automatically. All time sources are assumed to be UTC.

Simple Network Management Protocol (SNMP)

Simple Network Management Protocol (SNMP) is a protocol that can be used to manage and monitor network devices. Digi devices can be configured to use SNMP features, or SNMP can be disabled entirely for security reasons. To configure SNMP settings, click the **Simple Network Management Protocol** link at the bottom of the System Configuration page.

Supported SNMP-related RFCs, MIBs, and traps

Digi devices support these SNMP-related Request for Comments (RFCs) and Management Information Bases (MIBs):

| Number | Description | Location |
|-------------------------------------|---|---|
| Standard RFCs and MIBs: | | |
| RFC 1213 | Management Information Base (MIB) II. This is a MIB for managing a TCP/IP network. It is an update of the original MIB, now called MIB-I. MIB-II contains variable definitions that describe the most basic information needed to manage a TCP/IP network. These variable definitions are organized into several groups, such as groups for managing the system, network interfaces, address translation, transmission media, and various protocols, including IP, ICMP, TCP, UDP, EGP, and SNMP. | http://www.ietf.org/rfc/rfc1213.txt |
| RFC 1215 | Generic Traps (coldStart, linkUp, authenticationFailure only) | http://www.ietf.org/rfc/rfc1215.txt |
| RFC 1316 | Character MIB | http://tools.ietf.org/html/rfc1316 |
| RFC 1317 | RS-232 MIB | http://tools.ietf.org/html/rfc1317 |
| Digi enterprise MIBs: | | |
| Digi Connect Device Info MIB | A Digi enterprise MIB for handling and displaying basic device information, such as firmware revisions in use, device name, IP network information, memory use, and CPU statistics. | http://ftp1.digi.com/support/utilities/Digi Part number 40002410_x.mib |
| Digi Connect Mobile Information MIB | A Digi enterprise MIB for handling and displaying device information for mobile devices. | http://ftp1.digi.com/support/utilities/Digi Part number 40002593_x.mib |
| Digi Connect Wireless LAN MIB | A Digi enterprise MIB for handling and displaying basic device information for wireless devices. | http://ftp1.digi.com/support/utilities/Digi Part number 40002325_x.mib |
| Digi Host Resources MIB | A Digi enterprise MIB for use with managing host systems, where "host" means any computer that communicates with other similar computers attached to the internet and that is directly used by one or more human beings. | |
| Digi Serial Alarm Traps Management | A Digi enterprise MIB for sending alarms as SNMP traps. | http://ftp1.digi.com/support/utilities/Digi Part number 40002411_x.mib |

| Number | Description | Location |
|---|---|--|
| Digi Login Traps MIB | Indicates when users attempt to log into the device, and whether the attempt was successful. | http://ftp1.digi.com/support/utilities/ Digi Part number 40002339_x.mib |
| Digi Structures of Management (SMI) MIB | Data structures for managing hosts and gateways on a network. | http://ftp1.digi.com/support/utilities/ Digi Part number 40002195_x.mib |
| Digi Connect Mobile Traps MIB | A Digi enterprise MIB for sending alarms as SNMP traps for mobile devices. | http://ftp1.digi.com/support/utilities/ Digi Part number 40002594_x.mib |
| Digi Connectware Notifications MIB | This MIB may be required by some SNMP import facilities, as other MIBs may refer to it. | http://ftp1.digi.com/support/utilities/ Digi Part number 40002514_x.mib |
| Supported SNMP traps | | |
| | <p>SNMP traps can be enabled or disabled. Supported traps include:</p> <ul style="list-style-type: none"> Authentication failure Login Cold start Link up <p>Alarms can be issued in the form of SNMP traps.</p> <p>A large set of MIBs define these various trap types (unsolicited status message from the device).</p> <p>All products support MIBs for serial alarms / login traps/RFC 1215.</p> <p>Products with the geofencing/GPS feature support MIBs for geofencing.</p> <p>Products with mobile/cellular capability support MIBs for mobile alarms.</p> | <p>In the web interface, traps are enabled/disabled at Configuration > System > SNMP ></p> <p>Enable Simple Network Management Protocol (SNMP) traps</p> <p>Alarms are configured at Configuration > Alarms > Alarm Conditions > Alarm n > Alarm Destinations > Send SNMP trap to following destination when alarm occurs</p> |

SNMP Configuration settings:

- **Enable Simple Network Management Protocol (SNMP):** This checkbox enables or disables use of SNMP.
 - The **Public community** and **Private community** fields specify passwords required to get or set SNMP-managed objects. Changing public and private community names from their defaults is recommended to prevent unauthorized access to the device.

Public community: The password required to get SNMP-managed objects. The default is **public**.

Private community: The password required to set SNMP-managed objects. The default is **private**.
 - **Allow SNMP clients to set device settings through SNMP:** This checkbox enables or disables the capability for users to issue SNMP “set” commands uses use of SNMP read-only for the Digi device.
- **Enable Simple Network Management Protocol (SNMP) traps:** Enables or disables the generation of SNMP traps.
 - **Trap Destinations:**
 - **Primary/Secondary:** The IP address of the system to which the SNMP agent should send traps. To enable any of the traps, a non-zero value must be specified. The primary destination is required. The secondary destination is optional. For Digi devices that support alarms, this field is required in order for alarms to be sent in the form of SNMP traps. See "Alarms" on page 151.

At the bottom of the page are checkboxes for the SNMP traps that can be used:

- **Generate authentication failure traps:** The SNMP agent will send SNMP authentication traps when there are authentication failures.
- **Generate login traps:** The SNMP agent will send SNMP login traps on login attempts.
- **Generate cold start traps:** The SNMP agent will send traps on cold starts of the Digi device.
- **Generate link up traps:** The SNMP agent will send link up traps when network connections are established.

Remote management settings

The Remote Management configuration page sets up the connection to the iDigi Platform remote management server so the Digi device knows how to connect to the server. The iDigi Platform allows devices to be configured and managed from remote locations. To use the iDigi Platform as a remote manager of a Digi device, follow the procedures that begin on page 50.

There are two pages of remote management settings: Connections and Advanced settings.

Connection settings

The Connection settings configure how the Digi device connects to a remote management server. These settings include information about communication between client and server and the connection methods used by the various interfaces on the system.

About client-initiated and server-initiated connections

Digi devices can be configured to connect to and communicate with a remote management server through client-initiated or server-initiated connections. To illustrate how both types of connections work, here is a configuration scenario featuring Digi devices communicating over a cellular network with a remote management server running in the home office.



Addresses for Digi devices can be publicly known, or private and dynamic, or handled through Network Address Translation (NAT). NAT reduces the need for a large amount of publicly known IP addresses by creating a separation between publicly known and privately known IP addresses. NAT allows a single device, such as a router, to act as an agent between a public network, such as the Internet or a wireless network, and a private, or local, network. This means that only one unique IP address is needed to represent an entire group of computers. Addresses handled through NAT can access the rest of “the world,” but “the world” cannot access them.

In a *client-initiated connection*, the Digi device attempts to connect to the network, and will continue attempts to reach the remote management server to establish the connection. To maintain the connection, the Digi device sends *keep-alive messages* over the connection. The frequency with which keep-alive messages are sent is configurable. An advantage of client-initiated connections is that they can be used in any cellular network, whether public or private IP addresses are used, or even if NAT is used. A disadvantage is that you can be charged for the Digi device sending the keep-alives, depending on your cellular/mobile service plan.

A *server-initiated connection* works the opposite way. The remote management server opens a TCP connection, and the Digi device must be listening for the connection to the remote management server to occur. An advantage of server-initiated connections is that you are not charged for sending the keep-alive bytes that are used in client-initiated connections. A disadvantage is that there is no way of knowing whether the devices displayed in the device list at the remote management server are offline or connected. The device list shows all the devices as disconnected until the remote management server does something to interact with them. In addition, server-initiated connections cannot be used if Digi devices have private IP addresses and are behind a NAT.

Last Known Address (LKA)

Changes to the IP address for a Digi device present a challenge in server-initiated connections, because the remote management server needs to locate the Digi device by its new IP address. Digi Cellular Family devices handle address changes by sending a Last Known Address (LKA) update to the remote management server. This permits the remote management server to connect back to the Digi device, or to dynamically update a DNS with the IP address of the device.

Client initiated management connection settings

- **Enable Remote Management and Configuration using a client initiated connection:** Configures the connection to the remote management server to be initiated by the remote management client, that is, this Digi device.
- **Server Hostname:** The IP address or hostname of the remote management server.
- **Automatically reconnect to the server after being disconnected**
Wait for: Whether to automatically reconnect to the server after being disconnected and waiting for the specified amount of time.

Server initiated management connection settings

- **Enable Remote Management and Configuration using a server initiated connection:** Configures the connection to the remote management server to be initiated by the remote management server.
- **Enable Last Known Address (LKA) updates to the following server:** Enables or disables a connection to a remote management server to inform that server of the IP address of the Digi device, known as a “last known address” (LKA) update. This permits the remote management server to connect back to the Digi Cellular Family device, or to dynamically update a DNS with the IP address of the device.
- **Server Hostname:** The IP address or hostname of the remote management server.
- **Retry if the LKA update fails:**
Retry every: These options specify whether another “last known address” update attempt should be made after a previous attempt failed, and how often the retry attempts should occur.

Advanced remote management settings

The default settings for remote management usually work for most situations. These Advanced settings are used in advanced situations. They are used to configure the idle timeout for the connection between the Digi device and the remote management server, and the keep-alive settings of the various interfaces (TCP and HTTP for mobile and Ethernet network connections). These settings should only be changed when the defaults do not properly work.

- **Connection Settings:** These settings configure the idle timeout for the connection between the Digi device and the remote management server.
 - **Disconnect when Connectware Management is idle:** Enables or disables the idle timeout for the connection. If enabled, the connection will be dropped, or ended, after the amount of time specified in the **Idle Timeout** setting.
 - **Idle Timeout:** The amount of time to wait before timing out the connection.
- **Mobile Settings:**
 - Ethernet Settings**
 - WiFi Settings:** These settings apply to client-initiated management connections over mobile/cellular, Ethernet, and Wi-Fi networks.
 - **Connectware Management Protocol Keep-Alive Settings:** These settings control how often keep-alive packets are sent over the client-initiated connection to the remote management server, and whether the device waits before dropping the connection.
 - Receive Interval:** The number of seconds to wait for a keep-alive message from the remote management server before assuming the connection is lost.
 - Transmit Interval:** The number of seconds to wait between sending keep-alive messages.
 - Important:** It is recommended that this interval value be set as long as your application can tolerate to reduce the amount of data traffic.
 - Assume connection is lost after *n* timeouts:** How many timeouts occur before the Digi device assumes the connection to the remote management server is lost and drops the connection.
 - **Connection Method:** The method for connecting to the remote management server.
 - TCP:** Connect using TCP. This is the default connection method, and is typically good enough for most connections. It is the most efficient method of connecting to the remote server in terms of speed and transmitted data bytes.
 - Automatic:** Automatically detect the connection method. This connection method is less efficient than TCP, but it is useful in situations where a firewall or proxy may prevent direct connection via TCP. Automatic will try each combination until a connection is made. This connection method requires the HTTP over Proxy Settings to be specified.
 - None:** This value has the same effect as selecting TCP.
 - HTTP:** Connect using HTTP.
 - HTTP over Proxy:** Connect using HTTP.

- **HTTP over Proxy Settings:** The settings required to communicate over a proxy network using HTTP. These settings apply when **Automatic** or **HTTP over Proxy** connection methods are selected.

Hostname: The name of the proxy host.

TCP Port: The network port number for the TCP network service on the proxy host.

Username:

Password: The username and password for logging on to the proxy host.

Enable persistent proxy connections: Specifies whether the Digi device should attempt to use HTTP persistent connections. Not all HTTP proxies correctly handle HTTP persistent connections. The use of persistent connections can improve performance of the exchange of messages between the device server and remote management server, when that connection is HTTP/proxy. The reason for this is that the same HTTP connection can be reused for multiple consecutive HTTP requests and replies, eliminating the overhead of establishing a new TCP connection for each individual HTTP request/reply, then closing that connection when the request is complete.

Manually configure a Digi device to connect to the iDigi Platform

To use iDigi Platform as a device manager for your Digi device, you need to manually configure the Digi device to connect to iDigi Platform.

- 1 Open the web interface for the Digi device and go to **Configuration > Remote Management**.
- 2 On the **Remote Management** settings page, enter the URL of the iDigi Platform connectivity server (for example, sd1-na.idigi.com) in the **Server Address** field under **Client-Initiated Management Connection**. You can find this URL from the iDigi Platform user portal screen header near the top of the screen under **About > Log Off**.
- 3 Click the check box labeled **Automatically reconnect to the server after being disconnected**.
- 4 Click **Apply**.

Managing alarms through a remote management server

All alarms can be sent to a remote management server for display and management from that interface. See "Alarms" on page 151.

Security settings

Security settings involve several areas:

- **User authentication:** whether authentication is required for users accessing the Digi device, and the information required to access it. You can choose to have the user authentication be by username and password or by an SSH public key. Depending on the Digi product, multiple users and their authentication information can be defined. User authentication settings are on the Security settings page.
- **Network Configuration settings** to further secure your device: Digi devices with Cellular capability present additional security considerations, mainly involving securing the border between the Digi device and the cellular network. Several settings on the Network Configuration pages are available to further secure the Digi device. For example, unused network services can be disabled on the Network Services page. On the IP Filtering page, you can allow access from a specified devices and networks, and drop all other connection attempts.

About user models and user permissions

In Digi devices that have a one-user model:

- By default, there is no login prompt.
- The default name for user 1 is **root**. This user is also known as the administrative user.
- User 1 has permissions that enables it to do all commands. Permissions cannot be altered.

Password authentication

By default, there is no password authentication for ConnectPort X Family devices. When accessing the Digi device by opening the web interface or issuing a telnet command, no login prompt is displayed.

Enable password authentication

If desired, enable password authentication for the Digi device.

In the web interface:

- 1 On the Main menu, click **Security**.
- 2 On the Security Configuration page, check the **Enable password authentication** check box.
- 3 Enter the new password in the **New Password** and **Confirm Password** edit boxes.
- 4 Click **Apply**.
- 5 A prompt is displayed to immediately log back in to the web interface using the new values.

From the command line:

To enable the login prompt for a device that uses the one-user model, issue a **newpass** command with a password length of one or more characters.

Disable password authentication

Password authentication can be disabled as needed.

In the web interface:

- 1 On the Main menu, click **Security**.
- 2 On the **Security Configuration** page, check the **Enable password authentication** check box.
- 3 Click **Apply**.

From the command line:

Issue a **newpass** command with a zero-length password.

Change the password for administrative user

To increase security, change the password for the administrative user from its default. By default, the administrative username is **root**.

Note Record the new password. If the changed password is lost, the Digi device must be reset to the default firmware settings.

In Digi devices with a single-user model, changing the root password also changes the password for Advanced Digi Discovery Protocol (ADDP). In Digi devices with the multi-user model, changing the root password has no effect on ADDP. To change the ADDP password, enter **newpass name=addp** from the command line.

In the web interface:

- 1 On the Main menu, click **Security**.
- 2 On the **Security Configuration** page, enter the new password in the **New Password** and **Confirm Password** edit boxes. The password can be from 4 through 16 characters long and is case-sensitive. Click **Apply**.
- 3 A logoff is forced immediately. Log in to the web interface using the new values.

From the command line:

Issue the **newpass** command.

Upload an SSH public key

SSH can be configured to log into servers without having to provide a password. This is called “public key authentication” and is more secure than using a normal password.

You generate a public/private key using a program called ssh-keygen, and store a copy of the public key on the server(s) that you wish to use for authentication. When you attempt to log in, the server sends you a message encrypted with your public key. Your machine decrypts it and sends back the original message, proving your identity.

To upload an SSH public key:

- 1 On the Main menu, click **Security**.
- 2 On the Security Configuration page, check the Enable SSH public key authentication check box.
- 3 Type or paste the SSH public key in the edit box.
- 4 Click **Apply**.

Depending on your mobile service provider, other users can access your Digi device over the Internet, through various network services enabled on your Digi device. To further secure the Digi device, network services not necessary to the device, particularly non-secure or un-encrypted network services such as Telnet, can be disabled. See "Network services settings" on page 75.

Use IP filtering

You can better restrict your device on the network by only allowing certain devices or networks to connect. This is known as IP filtering or Access Control Lists (ACL). IP filtering configures a Digi device to accept connections from specific and known IP addresses or networks only, and silently drop other connections. Digi devices can be filtered on a single IP address or restricted as a group of devices using a subnet mask that only allows specific networks to access to the device. IP Filtering settings are a part of the Network configuration settings. See "IP filtering settings" on page 81.

Important: Plan and review your IP filtering settings before applying them. Incorrect settings can make the Digi device inaccessible from the network.

Position (GPS support)

Certain Digi devices have native GPS support with a geofence application. There are two groups of position settings. Static position settings define the latitude and longitude coordinates for the Digi device. GPS geofence settings define perimeters around a point such that moving into, out of, or being outside of the perimeter will be reported to the Digi device's event log, an SNMP server, or reported via e-mail. A supported GPS receiver must be configured for use by the device.

A GPS drive allows GPS data to be read from devices providing an NMEA-0183-compliant serial stream via serial or USB. Data can be used by Python, the web interface, command line, the iDigi Platform, and the geofencing application.

Static Position Settings

The static position settings define latitude and longitude coordinates for the Digi device. These parameters can be queried with the RCI protocol, and this information can be used by applications such as the iDigi Platform.

- **Latitude:** The static latitude of the device, in degrees (-90.0 - 90.0).
- **Longitude:** The static longitude of the device, in degrees (-180.0 - 180.0).

Geofence Settings

Up to 16 geofences can be defined. To add a geofence, click the **Add** button. The configuration settings for the geofence are displayed.

General Settings

- **Name:** A name to reference this geofence. This name will appear in the event log, SNMP trap, and/or e-mail report.
- **Latitude:** Latitude of the center of the geofence, in degrees (-90.0 - 90.0).
- **Longitude:** Longitude of the center of the geofence, in degrees (-180.0 - 180.0).
- **Maximum HDOP:** This is the maximum tolerated horizontal dilution of precision that is allowed for reporting a geofence event. When the reported HDOP is greater than this value, fence event log reports, SNMP traps, and e-mail reports will not be sent. HDOP tolerances vary by receiver.
- **Entry Radius:** The entry radius, in meters, is the distance from the center of the fence for entry. That is, if the device is less than this distance from the defined center, an entry event has occurred.
- **Exit Radius:** The exit radius, in meters, is the distance from the center of the fence for exit. That is, if the device is more than this distance from the defined center, an exit event has occurred. This is also the distance used to determine if the device is outside of the fence for update events.
- **Location Update Interval:** The location update interval, in seconds, specifies the amount of time to wait between reporting that the device is outside of the geofence. This applies to event log, SNMP, and e-mail reports.

Email Settings

- **Notify on Fence Entry:** An e-mail will be sent to the defined recipients via the configured SMTP servers when the device has entered the geofence defined by the geofence center and entry radius.
- **Notify on Fence Exit:** An e-mail will be sent to the defined recipients via the configured SMTP servers when the device has left the geofence defined by the geofence center and exit radius.
- **Send Location Update Notifications When Outside Fence:** An e-mail will be sent to the defined recipients via the configured SMTP servers when the device is outside of the geofence defined by the geofence center, and exit radius. E-mails will be sent at the interval defined by the location update interval parameter.
 - **Primary SMTP Server Address:** The IPv4 address of the primary SMTP email server.
 - **Secondary SMTP Server Address:** The IPv4 address of the secondary SMTP email server.
 - **Recipient:** The email address of the recipient of the geofence report e-mail.
 - **CC: Recipient:** The email address of the carbon copy (CC:) recipient of the geofence report e-mail.
 - **From:** The email (return) address of the originator of the geofence report e-mail.
 - **Subject:** The subject line that will appear on the geofence report e-mail.
 - **Priority:** The priority of the e-mail. Normal and high priority can be specified.
- **Include Location Data in Body:** Checking this indicates that the current location of the device should be included in the geofence e-mail.
 - **Body Text:** This parameter specifies the body text for the e-mail.

SNMP Settings

- **Trap on Fence Entry:** An SNMP trap will be sent to the defined SNMP servers when device has entered the geofence defined by the geofence center, and entry radius.
- **Trap on Fence Exit:** An SNMP trap will be sent to the defined SNMP servers when the device has left the geofence defined by the geofence center, and exit radius.
- **Send Location Update Traps When Outside Fence:** An SNMP trap will be sent to the defined SNMP servers when the device is outside of the geofence defined by the geofence center, and exit radius. SNMP traps will be sent at the interval defined by the location update interval parameter.

Event Log Settings

- **Send Fence Entry Events to Event Log:** A log entry will be written when device has entered the geofence defined by the geofence center, and entry radius.
- **Send Fence Exit Events to Event Log:** A log entry will be written when the device has left the geofence defined by the geofence center, and exit radius.
- **Send Location Update to the Event Log When Outside of the Fence:** A log entry will be written when the device is outside of the geofence defined by the geofence center, and exit radius. Log entries will be written at the interval defined by the location update interval parameter.

Applications

Several Digi devices support additional configurable applications. For most devices, these applications are accessed from the main menu under **Applications**. Some devices have an **Applications** link under **Configuration**.

Python[®] program management

Digi incorporates a Python development environment into Digi devices. Python is a dynamic, object-oriented language that can be used for developing a wide range of software applications, from simple programs to more complex embedded applications. It includes extensive libraries and works well with other languages. A true open-source language, Python runs on a wide range of operating systems, such as Windows, Linux/Unix, Mac OS X, OS/2, Amiga, Palm Handhelds, and Nokia mobile phones. Python has also been ported to Java and .NET virtual machines. Unlike proprietary embedded development platforms, Digi's integration of the universal Python programming language allows customers a truly open standard for complete control of connections to devices, the manipulation of data, and event based actions.

Recommended distribution of Python interpreter

The current version of the Python interpreter embedded in Digi devices is 2.4.3. Please use modules known to be compatible with this version of the Python language only.

Software development resources

Digi provides several resources to help you get started developing software solutions in Python:

Digi Python Programming Guide

This guide introduces the Python programming language by showing how to create and run a simple Python program. It reviews Python modules, particularly modules with Digi-specific behavior. It describes how to load and run Python programs onto Digi devices, either through the command-line or web user interfaces, and how to run several sample Python programs. Find this guide at the Digi Python Wiki page--in the **Start Here** section, click the link titled

Digi Python Programmer's Guide

http://www.digi.com/wiki/developer/index.php/Python_Wiki

General Python programming language is available at <http://www.python.org/>

Click the **Documentation** link.

Digi Developer Community Wiki

The Digi Developer Community Wiki is a place to learn about developing solutions using Digi's software and services, including Python, iDigi Platform, iDigi Dia, and more.

http://www.digi.com/wiki/developer/index.php/Main_Page

Digi Python Custom Development Environment page

Python functions can be used to obtain data from attached and integrated sensors on Digi products that have embedded XBee RF modules, such as the Drop-in Networking Accessories. The Digi Python Custom Development Environment page is an access point: for such information.

<http://www.digi.com/technology/drop-in-networking/python.jsp>

Python Support Forum on digi.com

Find answers to common questions and exchange ideas and examples with other members of the Digi Python development community at:

<http://www.digi.com/support/forum/forum.jspa?forumID=104>

Python configuration pages

Selecting **Applications > Python** from the main menu for a Python-enabled Digi device displays the Python Configuration pages. These pages are used to manage Python program files including uploading them to Digi devices and deleting them as needed, and configure Python programs to execute when the Digi device boots, also known as auto-start programs.

Python files

The **Python Files** page is for uploading and managing Python programs on a Digi device.

- **Upload Files:** Click **Browse** to select a file to upload to and click **Upload**.
- **Manage Files:** Select any files to remove from the Digi device and click **Delete**.

Auto-start settings

The **Auto-start Settings** page configures Python programs to execute when the Digi device boots. Up to four auto-start programs can be configured.

- **Enable:** When checked, the program specified in the Auto-start command line field will be run when the device boots.
- **Auto-start command line:** Specify the Python program filename to be executed and any arguments to pass to the program. The syntax is:

```
filename [arg1 arg2...]
```

Manually execute uploaded Python programs

To manually execute an uploaded Python program on a Digi device, access the command line of the device and enter the command:

```
python filename [arg1 arg2...]
```

View and manage executing Python programs

To view Python threads running on the Digi device, access the command line and enter the **who** command.

RealPort configuration

RealPort software must be installed and configured on each PC that uses the RealPort ports on the Digi device. This RealPort software is available for downloading from the Digi Support site.

Install RealPort software

From the Digi Support site:

- 1** From a browser, go to **www.digi.com**.
- 2** Click the **Support** link and select **Drivers**.
- 3** Under **Select Your Product for Support**, select your Digi device from the product list and click **Submit**.
- 4** Under **Active Products**, select your Digi device from the product list.
- 5** Under **OS Specific Diagnostics, Utilities and MIBs**, select the operating system for your computer from the list.
- 6** Under **Realport for Windows**, click the zip file.
- 7** Unzip the zip file.
- 8** Run the RealPort setup wizard.

RealPort configuration settings

Applications > Realport displays a page for configuring the RealPort application. Settings on this page include:

■ RealPort Settings

- **Enable Keep-Alives:** Enables sending of RealPort keep-alives. These keep-alives are messages inside the RealPort protocol, sent approximately every 10 seconds, to tell whoever is connected that the connection is still alive. RealPort keep-alives are different from TCP keep-alives, which are done at the TCP layer.

Note that RealPort keep-alives generate additional traffic which may be undesirable in situations where traffic is measured for billing purposes.

- **Enable Exclusive Mode:** Exclusive mode allows a single connection from any one RealPort client ID to be connected only. If this setting is enabled and a subsequent connection occurs that has the same source IP as an existing connection, the old existing connection is forcibly reset under the assumption that it is stale.

■ Device Initiated RealPort Settings:

- **Index:** An empty list means that no device initiated RealPort connections have been configured
- **Host or IP Address:** The IP address or DNS name of the client to connect to.
- **Port:** The network port to connect to on the client. The default port for VNC servers is 8771.
- **Retry Time:** The amount of time in seconds to wait before reattempting a failed connection to the client.

Ekahau Client™

For Digi devices with Wi-Fi capability, clicking **Ekahau Client** displays a page for configuring Ekahau Client device-location software.

The Ekahau Client feature provides integrated support for Ekahau's Wi-Fi device-location solution, called the Ekahau Positioning Engine, on the Digi Connect Wi-ME, Digi Connect Wi-EM, and Digi Connect Wi-SP products. Ekahau offers a complete access point vendor-independent real-time location system for wireless LAN devices that is capable of pinpointing wireless LAN devices such as the Digi Connect products, laptops, PDAs, or other intelligent Wi-Fi enabled devices. The solution provides floor-, room- and door-level accuracy of up to 3.5 feet (1 m). The patented Ekahau positioning technology is based on simple signal-strength calibration maps, and enables customers to fully leverage an existing wireless LAN infrastructure without any need for proprietary hardware components.

Visit www.ekahau.com for additional information, including free evaluation licenses for the Ekahau Positioning Engine and Ekahau Site Survey software products.

The screenshot shows the 'Ekahau Client™ Configuration' web interface. At the top, there is a blue header with the title. Below the header, a checkbox labeled 'Enable Ekahau Positioning Engine Client™' is checked. The interface is divided into two main sections: 'Ekahau Server Settings' and 'Device Descriptors'. The 'Ekahau Server Settings' section includes fields for 'Server Hostname' (192.168.1.12), 'Connection Protocol' (a dropdown menu set to 'TCP'), 'Server Port' (8548), 'Poll Rate' (5 secs), and 'Password' (Llama). The 'Device Descriptors' section includes fields for 'Device ID' (4321) and 'Device Name' (Connect Wi-ME #4321). At the bottom left of the form, there is an 'Apply' button.

| Ekahau Client™ Configuration | |
|--|---------------------|
| <input checked="" type="checkbox"/> Enable Ekahau Positioning Engine Client™ | |
| Ekahau Server Settings | |
| Server Hostname: | 192.168.1.12 |
| Connection Protocol: | TCP |
| Server Port: | 8548 |
| Poll Rate: | 5 secs |
| Password: | Llama |
| Device Descriptors | |
| Device ID: | 4321 |
| Device Name: | Connect Wi-ME #4321 |
| <input type="button" value="Apply"/> | |

Ekahau Client configuration settings include:

- **Enable Ekahau Positioning Engine Client™**: Enables or disables the Ekahau Positioning Engine Client feature.
 - **Ekahau Server Settings**: Configures how the Ekahau Positioning Engine Client communicates with the server. **Server Hostname**: The hostname or IP address of the Ekahau Positioning Engine. The maximum length of this option is 50 characters. The default is 8548.
 - **Connection Protocol**: Specifies whether to use TCP or UDP as the network transport. The default is TCP.
 - **Server Port**: The network port to communicate on. In the default Ekahau configuration, port 8548 is used for TCP, and port 8549 for UDP.
 - **Poll Rate**: The time in seconds between each scan or wireless access points and communication with the server. Once the Ekahau Client is enabled, every time the Digi device scans the network, it is essentially disassociated with the access point (AP) providing its network connectivity. In addition, during the time, or scanning interval, set by the poll rate, it will not be receiving or transmitting wireless packets. This could lead to packet loss. Set the poll rate as slow as acceptable in the application where the Digi device is being used. The default is five seconds.
 - **Password**: A password to authenticate with the server. The maximum length of this option is 50 characters. The default for Digi and the Ekahau Positioning Engine is **Llama**.
- **Device Descriptors**:
 - **Device ID**: A numeric identifier for the Digi device, used internally by the Ekahau Positioning Engine for device tracking over time. This identifier should be unique for each Digi device being located on the network.
 - **Device Name**: A descriptive name to identify the Digi device to users. The maximum length of this option is 50 characters.

Industrial Automation/Modbus Bridge

Industrial Automation is supported in these Digi devices: ConnectPort X2 (non-Python version), and ConnectPort X4.

Currently, from the web interface, it is only possible to select a different port profile than **Industrial Automation**, or change the serial port settings, such as baud rate and parity. If changes are needed from the settings established by the Industrial Automation port profile, use the **set ia** command from the command-line interface.

Known limitations

- Digi RealPort can be used only if the Modbus Bridge function is disabled. RealPort with Modbus/RTU or ASCII cannot be used to access the Modbus Bridge function.
- The outgoing slave idle time used for remote Modbus IP-based slaves does not always close idle sockets predictably.
- While the Modbus bridge is active, do not attempt to “Port Forward” TCP 502 or UDP 502 to local Modbus/TCP servers while the Modbus Bridge is active. This causes neither function to work. Disable the Modbus Bridge if traditional Router/NAT function for Modbus/TCP port 502 is desired.

Disabling and enabling the Modbus Bridge

To disable the Modbus Bridge, select a different port profile than Industrial Automation. To enable it, reselect the Industrial Automation port profile. Any specialized settings that had been set through “set ia” commands are lost by disabling the Modbus bridge. They must be reconfigured when you reselect the Industrial Automation profile.

More information on Industrial Automation/Modbus

For more information on Industrial Automation, see the “set ia” command description in the *Digi Connect Family Command Reference*, and the application note *Remote Cellular TCP/IP Access to Modbus Ethernet and Serial Devices*, part number 90000773, available on the digi.com Support page at <http://www.digi.com/support>.

Configuration through the command line

Configuring a Digi device through the command-line interface consists of entering a series of commands to set values in the device. The *Digi Connect Family Command Reference* describes the commands used to configure, monitor, administer, and operate Digi devices.

Access the command line

To configure devices using commands, first access the command line. Either launch the command-line interface from the last page of the Digi Device Setup Wizard or use the **telnet** command. Enter the **telnet** command from a command prompt on another networked device, such as a server, as follows:

```
#> telnet ip-address
```

where *ip-address* is the IP address of the Digi device. For example:

```
#> telnet 192.3.23.5
```

If security is enabled for the Digi device, (that is, a username and password have been set up for logging on to it), a login prompt is displayed. If the user name and password for the device are unknown, contact the system administrator who originally configured the device.

Verify device support of commands

To verify whether a Digi device supports a particular command, online help is available. For example:

- **help** displays all supported commands for a device.
- **?** displays all supported commands for a device
- **set ?** displays the syntax and options for the **set** command. Use this command to determine whether the device includes a particular “set” command variant to configure various features.
- **help set** displays syntax and options for the **set** command.
- **set serial ?** displays the syntax and options for the **set serial** command.
- **help set serial** displays the syntax and options for the **set serial** command.

Here are some examples of commands used to configure Digi device. See the Introduction of the *Digi Connect Family Command Reference* for a complete list of features and tasks that can be configured and performed from the command line.

| To configure: | Use this command: |
|---|---|
| access control (IP filtering): limit network access to device | set accesscontrol |
| alarms | set alarms |
| autoconnection behaviors for serial port connections | set autoconnect |
| Ethernet communications parameters | set ethernet |
| IP forwarding | set forward |
| host name | set host |
| mobile statistics | display mobile |
| modem emulation | set pmodem |
| network options | set network |
| network services | set service |
| Point-to-Point (PPP) outbound connections | set pppoutbound |
| port buffering | set buffer |
| port profile for a serial port | set profiles |
| provisioning CDMA cellular modules | display provisioning provision |
| remote management settings | set mgmtconnection set mgmtglobal set mgmtnetwork |
| system-identifying information | set system |
| serial port options--general | set serial |
| serial TCP | set tcpserial |
| RealPort configuration options | set realport |
| router and Network Address Translation settings | set nat |

| To configure: | Use this command: |
|--|---------------------|
| RTS toggle | set rtstoggle |
| SNMP | set snmp |
| Telnet control commands: send Telnet control command to last active Telnet session; set Telnet operating options | send mode |
| users and passwords | set user newpass |
| wireless devices | set wlan |
| XBee network settings including ZB, 802.15.4, and other XBee RF protocols | set xbee |

Configuration through Simple Network Management Protocol (SNMP)

Configuring Digi devices through Simple Network Management protocol uses a subset of standard MIBs for network and serial configuration, plus several Digi enterprise MIBs for device identification and alarm handling. These MIBs are listed and described on page 158, and must be loaded into a network management station (NMS). The standard and Digi Enterprise MIBs allow for very basic network and serial configuration. For more detailed configuration settings, use the command-line interface or web interface instead.

Some elements of SNMP configuration can only be configured from the web interface or command line, such as the setting to send alarms as SNMP traps. In the web interface, this setting is located at **Configuration > Alarms > alarm > Alarm Destinations > Send SNMP trap to following destination when alarm occurs**. See "Alarms" on page 151. In the command-line interface, this setting is configured by the **set alarm** option **type=snmptrap**. See the **set alarm** command description in the *Connect Family Command Reference*.

For information on SNMP as a monitoring interface, see page 209.

Batch capabilities for configuring multiple devices

For configuring many Digi devices at a time, batch configuration capabilities for uploading configuration files are available through the Digi Connect Programmer. For details and command descriptions, see the *Digi Connect Family Customization and Integration Guide*.

Monitor and manage Digi devices

C H A P T E R 4

The port, device, system, and network activities of Digi devices can be monitored from a variety of interfaces. Changes in data flow may indicate problems or activities that may require immediate attention. In addition, connections and network services can be managed.

This chapter discusses monitoring and connection-management capabilities and tasks in Digi devices. It covers these topics:

- Monitoring capabilities from the iDigi Platform on page 183
- Monitoring and Digi devices and manage their connections from the web-based interface on page 184
- Monitoring Digi devices from the command line on page 205
- Monitoring capabilities from SNMP on page 209

Monitoring capabilities from the iDigi Platform

Digi devices can be monitored and managed from iDigi Platform; for example.

- Displaying detailed state information and statistics about a device, such as device up time, amount of used and free memory, network settings, XBee network overview and detailed information on network nodes.
- Mobile settings
- Monitoring the state of the device's connection and see a connection report and connection history statistics.
- Redirecting devices to a to a different destination
- Disconnecting devices
- Removing devices from the network.

To learn more about the iDigi Platform and the services it provides, see the *iDigi Device Management and Web Services Tutorial*.

Monitor/manage XBee networks

Several views in the iDigi Platform are used for viewing and configuring XBee networks, including the device list, Mesh network view, and node view. See "iDigi Platform views for configuring and managing Digi devices" on page 53 for examples of these views.

Monitoring capabilities in the web interface

Several device monitoring and connection-management capabilities are available in the web interface including system information and statistics, and connection management information.

Display system information

The System Information pages display general system information, serial port information, network statistics, mobile information and statistics, and diagnostics. This information is typically used by technical support to troubleshoot problems. To display these pages, go to **Administration > System Information**.

General system information

Model

The model of the Digi device.

MAC Address

A unique network identifier required for all network devices. The MAC address is on a sticker on the Digi device and is displayed as 12 hexadecimal digits, usually starting with 00:40:9D.

Firmware Version

The current firmware version running in the Digi device. This information may be used to help locate and download new firmware. Firmware updates can be downloaded from: <http://support.digi.com/support/firmware>.

Boot Version

The current boot code version running in the Digi device.

POST Version

The current Power-On Self Test (POST) code version running in the Digi device.

CPU Utilization

The amount of CPU resources being used by the Digi device.

Important: 100% CPU Utilization may indicate encryption key generation is in-progress. On initial boot, the Digi device generates some encryption key material: an RSA key for SSL/TLS operations, and a DSA key for SSH operations. This key-generation process can take as long as 40 minutes. Until the RSA or DSA key is generated, the Digi device will be unable to initiate or accept that type of encrypted connection. The Digi device reports itself as 100% busy, but since key generation occurs at a low priority, the device will still function normally. On subsequent reboots, the Digi device will use its existing keys and not need to generate another unless a reset to factory defaults is done, which will cause a new key to be generated on the next reboot.

Up Time

The amount of time the Digi device has been running since it was last powered on or rebooted.

Total/Used/Free Memory

The amount of memory (RAM) available, currently in use, and currently not being used.

Serial port information

The Serial page of System Information lists the serial ports that are configured for the Digi device. Click on a port to view the detailed serial port information.

Serial port diagnostics page

The Serial Port Diagnostics page of system information provides details that may aid in troubleshooting serial communication problems.

Configuration

The Configuration section includes the electrical interface (Port Type) and basic serial settings.

The screenshot displays the 'Serial Port Diagnostics - Port 1' interface. It features a title bar with 'Return to System Information', 'Previous', and 'Next' buttons. The main content is divided into three sections: Configuration, Signals, and Serial Statistics. A 'Refresh' button is located at the bottom.

| Configuration | |
|---------------|--------------|
| Profile: | <Unassigned> |
| Baud Rate: | 9600 bps |
| Data Bits: | 8 |
| Parity: | None |
| Stop Bits: | 1 |
| Flow Control: | Software |
| Port Type: | RS-232 |

| Signals | | | | | | |
|-------------------------------------|--------------------------|-------------------------------------|--------------------------|--------------------------|--------------------------|--------------------------|
| RTS | CTS | DTR | DSR | DCD | IFC | OFC |
| <input checked="" type="checkbox"/> | <input type="checkbox"/> | <input checked="" type="checkbox"/> | <input type="checkbox"/> | <input type="checkbox"/> | <input type="checkbox"/> | <input type="checkbox"/> |

| Serial Statistics | | | |
|-------------------|---------|------------------|---------|
| Total Data In: | 0 bytes | Total Data Out: | 5 bytes |
| Overflow Errors: | 0 | Overflow Errors: | 0 |
| Framing Errors: | 0 | Parity Errors: | 0 |
| Breaks: | 0 | | |

Signals

The **Signals** section shows the serial port signals. Signals are green when asserted (on) and gray when not asserted (off). Signal definitions are:

RTS: Request To Send.

CTS: Clear To Send.

DTR: Data Terminal Ready.

DSR: Data Set Ready.

DCD: Data Carrier Detected.

OFC: Output Flow Control. Indicates that flow control is enabled on the remote side of the serial-port connection, and that the Digi device should stop sending data.

IFC: Input Flow Control. Indicates that the Digi device is operating as if flow control is enabled for incoming data sent from the remote side of the serial-port connection. This signal is more of an indication that flow control is intended or expected rather than true state information. If the remote side has a flow-control mechanism enabled, the Digi device will use it.

Serial statistics

The Serial statistics section includes data counters and error tracking that will help determine the quality of data that is being sent or received. If the error counters are accumulating, there may be a problem in the Digi device.

Total Data In: Total number of data bytes received.

Total Data Out: Total number of data bytes transmitted.

Overrun Errors: Number of overrun errors - the next data character arrived before the hardware could move the previous character.

Overflow Errors: Number of overflow errors - the receive buffer was full when additional data was received.

Framing Errors: Number of framing errors received - the received data did not have a valid stop bit.

Parity Errors: Number of parity errors - the received data did not have the correct parity setting.

Breaks: Number of break signals received.

Network statistics

Network statistics are detailed statistics about network and protocol activity that may aid in troubleshooting network communication problems. Statistics displayed are those gathered since the unit was last rebooted. If an error counter accumulates at an unexpected rate for that type of counter, there may be a problem in the Digi device.

Ethernet Connection Statistics

Speed

Ethernet link speed: 10 or 100 Mbps. N/A if link integrity is not detected, for example, if the cable is disconnected.

Duplex

Ethernet link mode: half or full duplex. N/A if link integrity is not detected, for example, if the cable is disconnected.

Bytes Received

Bytes Sent

Number of bytes received or sent.

Unicast Packets Received

Number of unicast packets received and delivered to a higher-layer protocol. A unicast packet is one directed to an Ethernet MAC address.

Unicast Packets Sent

Number of unicast packets requested to be sent by a higher-layer protocol. A unicast packet is one directed to an Ethernet MAC address.

Non-Unicast Packets Received

Number of non-unicast packets received and delivered to a higher-layer protocol. A non-unicast packet is one directed to either an Ethernet broadcast address or a multicast address.

Non-Unicast Packets Sent

Number of non-unicast packets requested to be sent by a higher-layer protocol. A non-unicast packet is one directed to either an Ethernet broadcast address or a multicast address.

Unknown Protocol Packets Received

Number of packets received that were discarded because of an unknown or unsupported protocol.

IP Statistics

Datagrams Received Datagrams Forwarded

Number of datagrams received or forwarded.

Forwarding

Displays whether forwarding is enabled or disabled.

No Routes

Number of outgoing datagrams for which no route to the destination IP could be found.

Routing Discards

Number of outgoing datagrams which have been discarded.

Default Time-To-Live

Number of routers an IP packet can pass through before being discarded.

TCP statistics

Segments Received Segments Sent

Number of segments received or sent.

Active Opens

Number of active opens. In an active open, the Digi device is initiating a connection request with a server.

Passive Opens

Number of passive opens. In a passive open, the Digi device is listening for a connection request from a client.

Bad Segments Received

Number of segments received with errors.

Attempt Fails

Number of failed connection attempts.

Segments Retransmitted

Number of segments retransmitted. Segments are retransmitted when the server doesn't respond to a packet sent by the client. This is to handle packets that might get lost or discarded somewhere in the network.

Established Resets

Number of established connections that have been reset.

UDP statistics

Datagrams Received Datagrams Sent

Number of datagrams received or sent.

Bad Datagrams Received

Number of bad datagrams that were received. This number does not include the value contained by **No Ports**.

No Ports

Number of received datagrams that were discarded because the specified port was invalid.

ICMP statistics

Messages Received

Number of messages received.

Bad Messages Received

Number of received messages with errors.

Destination Unreachable Messages Received

Number of destination unreachable messages received. A destination unreachable message is sent to the originator when a datagram fails to reach its intended destination.

WiFi LAN statistics

The WiFi LAN Statistics section displays more detailed wireless statistics that may aid in troubleshooting network communication problems in wireless Digi devices.

Status

The current status of the wireless Digi device, which may include:

Not Connected: not associated or connected w/ any access point, perhaps because the wireless device has not fully initialized, is out of range, or the wireless interface is disconnected because the Ethernet interface is enabled.

Searching for Network: searching for a wireless network or access point for connection.

Associated with Network: successfully associated with the network w/ the proper network settings and encryption.

Authenticated with Network: successfully authenticated a username/password with the network when WPA is enabled.

Joined Ad Hoc Network: successfully connected to and joined an ad-hoc network.

Started Ad Hoc Network: successfully created, started, and joined an ad-hoc network.

Network Name

The name of the wireless network to which the Digi device is connected.

Network ID

The ID of the wireless network to which the Digi device is connected and communicating.

Channel

The frequency channel used by the wireless LAN radio for the Digi device.

Transmit Rate

The current transmission rate for the wireless LAN radio.

Signal Strength

The current receive signal strength as reported by the wireless LAN radio. Ranges are from 0 to 100.

Mobile information and statistics

The Mobile information and statistics page displays detailed mobile statistics that may aid in troubleshooting network communication problems with your mobile network. The statistics displayed depend on whether your mobile service provider is GSM- or CDMA-based.

Mobile Connection Statistics

Registration Status

The status of the modem's connection to the cellular network:

Not Registered: Digi device is not currently searching a new operator to register to.

Registered: Home Network.

Not Registered: Digi device is currently searching a new operator to register to.

Registration Denied.

Unknown.

Registered - Roaming.

Cell ID

The modem's identifier in hexadecimal and decimal, for example: "00C3 (195)."

Location Area Code (aka "LAC")

The modem reports this value as a 4-hex-digit string. In the mobile statistics it is displayed both as hex and decimal representations. For example "00C3 (195)."

Signal Strength (RSSI)

The relative signal strength, displayed as signal strength LEDs.

0 LEDs: Unacceptable; Signal strength is not known or not detectable.

1 LED: Weak.

2 LEDs: Moderate.

3 LEDs: Good.

4: LEDs: Excellent.

Mobile Statistics

Mobile statistics include the interface status, bytes received and sent, baud rate, modem resets, and inactivity timer.

IP Address

The IP address of the PPP connection provided by the mobile service.

**Primary DNS Address
Secondary DNS Address**

The IP addresses of the DNS nameservers. Name lookups are performed using the nameserver specified on “dns1” first, and if that fails, the nameserver specified on “dns2” is used.

Data Received

Total number of data bytes received.

Data Sent

Total number of data bytes sent.

Idle Resets

The number of times the modem has been reset because no data was received for a period of time.

Inactivity Timer

The time, in seconds, after which if no data has received over the link, the mobile connection will be disconnected and re-established.

Mobile Information**IMSI**

International Mobile Subscriber Identifier (IMSI), a unique 15-digit number which designates the subscriber. This ID is the subscriber's code to access the cellular network, and is used by the network for provisioning and to admit the device/user to its provisioned services.

Phone Number

The phone number used to call the modem module. Two numbers are displayed: the Mobile Directory Number (MDN) and the Mobile Identification Number (MIN).

Modem Manufacturer

The manufacturer of the modem module.

Model

The model name of the modem module.

Modem Serial Number

The serial number of the modem module.

Modem Revision

The firmware revision in the modem module.

Other Mobile Information

Depending on your mobile service provider, other mobile information and settings may be provided after the modem revision.

IP Network Failover statistics

The IP Network Failover page is used to view detailed IP Network Failover status and statistics that may aid in troubleshooting network communication problems.

The IP Network Failover feature provides a dynamic method for selecting the default gateway. If failover is properly configured and enabled, it overrides the Gateway Priority selection in the Advanced Network Settings. If failover is off/disabled, the non-failover gateway configuration is enabled. To configure IP Network Failover, use the **IP Network Failover Settings** page in the Network Configuration area. See "IP Network Failover settings" on page 85. To configure the non-failover default gateway priority list, use the **Advanced Network Settings** page in the Network Configuration area. See "IP Network Failover settings" on page 85.

Current Default Gateway Status

This information reports the current status of the default gateway, including the interface name, default gateway IP address, and how the default gateway was configured (Failover or Non-Failover).

Current Network Failover Status

This information reports the current status of the Network Failover feature's management of the default gateway.

Failover State: The current configured state (On or Off) of Network Failover.

Fallback to Non-Failover: The current configured state (On or Off) of Network Failover option to fall back to Non-Failover. The fallback option is used if a default gateway cannot be configured by Network Failover. Failure to configure a default gateway could occur if one or more interfaces are not enabled (On) for Network Failover use, or if those enabled interfaces are not Up or do not have a gateway associated with them.

Interface Table

The current status of all available IP network interfaces. The table is displayed in order of the interface priority configured in the Network Failover settings. For each network interface, the following information is displayed:

Priority: The priority of the interface used by Network Failover. The highest priority is 1, which is the first interface in the configured Failover Interface Priority list.

Interface: The name of the network interface.

Status: The current failover status of this network interface. Possible status values and their meanings:

1 - Responding: The interface is Up and configured in the system. It is currently responding to the link tests. This interface is suitable for use as the default gateway.

2 - Up; The interface is Up and configured in the system. Its status has not been determined by the link tests, or no link tests are configured. This interface may be suitable for use as the default gateway.

3 - Not Responding: The interface is Up and configured in the system. However, it is not currently responding to the link tests, and the number of consecutive test failures has reached the threshold number configured in the Network Failover settings. This interface may be suitable for use as the default gateway.

4 - Down: The interface is Down or not configured in the system. However, it is not currently responding to the link tests. This interface is not suitable for use as the default gateway.

5 - Unknown: The interface is Unknown (does not exist) in the system. This interface is not suitable for use as the default gateway.

The number shown above for each status value indicates the priority of that status, used by failover in selecting the interface to use as the default gateway. Status priority 1 is the most suitable for use, with lower priorities considered suitable if there are no interfaces at the highest priority.

The interface list is maintained in the interface priority order configured in the Network Failover settings. When any interface changes status, the interface list is examined for the interface that has the highest status priority, nearest the start of the list. The highest priority interface with a Responding status is used as the default gateway. If no interface is marked Responding then the highest Up interface is used, etc.

Gateway

The gateway IP address associated with the interface, or 0.0.0.0 if the interface does not have an associated gateway. An interface with no gateway is not suitable for use as the default gateway.

State: The Network Failover enabled state (On or Off) for this interface. The On state means failover is monitoring this interface, and the Off state means failover is not using this interface for failover purposes.

Tests: The number of Link Tests (0, 1 or 2) that are configured for this interface.

Current Network Gateway Status (Non-Failover)

This information reports the status of the non-failover management of the default gateway. If Network Failover is enabled (On) and can successfully configure a default gateway, failover always overrides the non-failover Gateway Priority configuration.

Interface Table

The current status of all available IP network interfaces. The table is displayed in order of the interface priority configured in the Advanced Network Settings. For each network interface, the following information is displayed:

Priority: The priority of the interface configured in the Advanced Network Settings. The highest priority is 1, which is the first interface in the configured Advanced Network Settings Interface Priority list.

Interface: The name of the network interface.

Status: The current status of this network interface. Possible status values and their meanings:

1 - Up: The interface is Up and configured in the system. This interface is suitable for use as the default gateway.

0 - Down: The interface is Down or not configured in the system. This interface is not suitable for use as the default gateway.

The interface list is maintained in the Interface Priority order configured by the user in the Advanced Network Settings. When any interface changes status, the interface list is examined for the interface that has the highest status priority, nearest the start of the list. The highest priority interface with an Up status is used as the default gateway.

Gateway

The gateway IP address associated with the interface, or 0.0.0.0 if the interface does not have an associated gateway. An interface with no gateway is not suitable for use as the default gateway.

Current Failover Link Test Statistics

These statistics indicate the successes and failures of the configured link tests, used by the Network Failover feature to manage the default gateway. For each network interface, the following counters are maintained and reported. The values indicate the total number for each interface and category, since the Digi device was last powered on or rebooted.

Test Success

The total number of successful link tests. A link test is successful if either of the configured tests (primary or secondary destination) succeeds. When a link test succeeds, the interface is reported as “Responding”.

Test Failure

The total number of failed link tests. A link test fails if both of the configured tests (primary or secondary destination) fail, or if only one link test is configured and it fails. If two link tests are configured, and both of them fail, that is counted as a single link test failure for the purpose of counting failures.

Bypass Test

The total number of link tests that were bypassed (not run) for a number of possible reasons. A link test is bypassed if no destinations are configured, if the interface has no associated gateway, if the interface goes down while a test is in progress, or if failover is disabled (turned off) while a test is running (disabled as a feature or for the interface being tested).

Consecutive Failures

The current number of consecutive link test failures for the interface. When the number of consecutive failures reaches the threshold configured in the Network Failover settings, the interface is reported as “Not Responding” and the default gateway may be changed as a result. When a link test is successful, or when the interface goes down and comes back up, the consecutive failures counter is reset to zero.

Link Not Responding

The total number of link test failures that occurred for the interface after it has been reported as “Not Responding”. This counter can be a useful indicator for determining how much time an interface is in the state of “Not Responding”.

Position/GPS statistics

The Position statistics show information gathered from attached NMEA-0183 compliant GPS receivers attached to the Digi device, and statically configured position parameters.

Views and statistics for managing XBee networks

This section is used to view more detailed statistics for XBee module activity that may aid in troubleshooting network communication problems with your XBee network.

Digi provides several avenues for managing XBee networks and the devices in them:

- From a Digi device's web interface. This section focuses on this interface.
- From a Digi device's command-line interface. See "Commands for managing XBee networks and nodes" on page 208.
- From the iDigi Platform's XBee Networks view. See "Monitor/manage XBee networks" on page 183.

Manage XBee networks from the web interface

To display information about XBee networks and devices within them, select

Administration > System Information > XBee Network. The XBee Network page is displayed.

System Information

- ▶ General
- ▶ Serial
- ▶ Network
- ▶ Mobile
- ▶ IP Network Failover
- ▶ Position
- ▼ **XBee Network**

Gateway Device Details

PAN ID: 0x4f32 - 0x0000000000000a40
Channel: 0x15 (2455 MHz)
Gateway Address: 00:13:a2:00:40:0a:09:15!

Network View of the XBee Devices

| Node ID | Network Address | Extended Address | Node Type | Product Type |
|---------|-----------------|--------------------------|-------------|--------------|
| [0000]! | | 00:13:a2:00:40:0a:09:15! | coordinator | X4 Gateway |
| [26f9]! | | 00:13:a2:00:40:34:12:f1! | router | Unspecified |
| [78b2]! | | 00:13:a2:00:40:4a:b9:c8! | end node | |

Clear list before device discovery

Discover XBee Devices

Python Application XBee Socket Counters

| | | | |
|--------------|----|------------------|-----|
| Frames Sent: | 30 | Frames Received: | 26 |
| Bytes Sent: | 90 | Bytes Received: | 129 |

Python Application XBee Socket Error Counts

| | | | |
|-------------------------|---|------------------------|---|
| Transmit I/O Errors: | 0 | Transmit CCA Failures: | 0 |
| Transmit ACK Failures: | 0 | Not Joined Errors: | 0 |
| Self Addressed Errors: | 0 | No Address Errors: | 1 |
| No Route Errors: | 0 | Receive Frame Errors: | 0 |
| Received Bytes Dropped: | 0 | | |

Refresh

- ▶ Watchport Sensor
- ▶ Diagnostics

Gateway device details

This part of the display shows information about the Digi device and its role as a gateway device in the XBee network. It shows the current PAN ID, Channel, and address in use for the XBee network.

Network view of the XBee devices

This part of the display shows the gateway and any devices that have joined the XBee network. Click the **Discover XBee Devices** button to refresh the list of devices that have joined the xbee network. (The discovery operation may take a few seconds.) Click on a device's table entry to view more detailed information of the state of that device.

Python Application XBee Socket Counters

This section includes data counters that are specific to XBee Sockets implemented using a Python application.

Frames Sent: The total number of transmitted frames.

Frames Received: The total number of received frames.

Bytes Sent: The total number of bytes sent.

Bytes Received: The total number of bytes received.

Python Application XBee Socket Error Counts

This section includes error counters that are specific to XBee Sockets implemented using a Python application. These values will help determine the quality of data that is being sent or received, and are useful in troubleshooting communication errors in an XBee network.

Transmit I/O Errors: The total number of transmitted frames that could not be transmitted due to an I/O error.

Transmit CCA Failures: The total number of transmitted frames which could not be transmitted due to a CCA error.

Transmit ACK Failures: The total number of transmitted frames which could not be transmitted due to an ACK error.

Not Joined Errors: The total number of transmitted frames which were attempted to be transmitted to an unjoined node.

Self Addressed Errors: The total number of transmitted frames for which a node attempted to transmit to itself.

No Address Errors: The total number of transmitted frames for which the destination address could not be found.

No Route Errors: The total number of transmitted frames for which a router to the destination could not be found.

Receive Frame Errors: The total number of frames where an error occurred on receive.

Received Bytes Dropped: The total number of bytes dropped due to an exhaustion of internal buffers.

XBee device state pages

Clicking a device in the **Network View of the XBee Devices** displays the **XBee Device State** page for the selected device. This page is used to view more detailed information on the state of the node. The parameters displayed vary based on the capabilities supported by the node's XBee module. Here is an example XBee Device State page for the XBee module in a ConnectPort X gateway:

XBee Device State

XBee Node

| | |
|-----------------------|--------------------------|
| Physical Address: | 00:13:a2:00:40:0a:09:15! |
| Node Identifier (NI): | |
| Parent Address (MP): | 0xfffe |
| Type: | coordinator |
| Profile Id: | 0xc105 |
| Manufacturer's Id: | 0x101e |

RF Module

| | |
|------------------------------------|---------------------|
| PAN identifier (OI): | 0x4f32 |
| Extended PAN identifier (OP): | 0x00000000000000a40 |
| Operating channel (CH): | 0x0015 |
| Network address (MY): | 0x0000 |
| Association indication (AI): | 0x0000 |
| Firmware version (VR): | 0x2142 |
| Hardware version (HV): | 0x1903 |
| Device type identifier (DD): | 0x30002 |
| Number of remaining children (NC): | 10 |
| Maximum RF payload (NP): | 84 |
| Received signal strength (DB): | 31 |

Watchport Sensor statistics

To be provided.

SureLink statistics

Digi SureLink™ provides an “always-on” mobile network connection to ensure that a Digi device is in a state where it can connect to the network. The statistics displayed for Digi SureLink pertain to the periodic tests, known as Link Integrity Monitoring tests, that are run over the established PPP connection to ensure that end-to-end communication is possible. There are three Link Integrity Monitoring tests available: Ping Test, TCP Connection Test, and DNS Lookup Test. For descriptions of these tests, see "Link integrity monitoring settings" on page 117. In these SureLink statistics, a “session” is a PPP session. The session statistics are reset to zero at the start of a new PPP connection. The “total” statistics are the accumulated totals for all sessions since the device booted. The “tests” are the SureLink Link Integrity Monitoring tests that have been configured to be run when the mobile network connection is established.

session successes

The number of times a configured test was attempted and succeeded in the current PPP session.

session failures

The number of times a configured test was attempted but failed in the current PPP session.

session consecutive failures

The number of consecutive failures for a test, with no success. When a test is successful, the consecutive failures counter is reset to zero. The consecutive failures counter indicates a device's “progress” toward the configured maximum number of consecutive failures, after which the PPP link is taken down (and restarted).

session bypasses

If a configuration parameter is bad, a test is bypassed rather than considered to have succeeded or failed. This means the test was not run. If the PPP connection goes down while a test is in progress, that test may be classified as bypassed, since it could not be run. (Note that the PPP link may come down for many reasons, independent of SureLink testing.)

total successes

The total number of times a configured test was attempted and succeeded since the Digi device was booted.

total failures

The total number of times a configured test was attempted but failed since the Digi device was booted.

total link down requests

The number of times the SureLink feature has failed consecutively the configured number of failures and, as a result, requested that PPP shut down and restart its connection. This statistic counts such occurrences during the current device boot. SureLink itself does not do the PPP stop/start; it sends a message to PPP asking it to do so, owing to a Surelink test failure.

total bypasses

The total test bypasses (see “session bypasses”) since the Digi device was rebooted.

Diagnostics

The **Diagnostics** page provides a ping utility to determine whether the Digi device can access remote devices over the network. Enter the hostname of the remote device to attempt to access, and click **Ping**.

Manage connections and services

The **Management** menu is for viewing and managing connections and services for the Digi device.

Manage serial ports

Management > Serial Ports provides an overview of the serial ports and their connections. Clicking **Connections** displays the active connections for that serial port. The view can be refreshed to see any new serial-port connections list, and connections can be disconnected as needed.

Manage connections

Management > Connections displays active Virtual Private Network (VPN) and system connections.

Manage Virtual Private Network (VPN) connections

To monitor a VPN connection from the web interface, select **Management > Connections**. The VPN settings appear. Note that the **Connect** and **Disconnect** functions do not work for a VPN that uses a Pre-Shared Key (PSK).

Manage active system connections

The Active System Connections list provides an overview of connections associated with various interfaces, such as user connections to the device's web interface, connections to the command line through the local shell, or Python threads currently running; the protocols used for the connections; and the number of active sessions for each connection. One of the uses of this list is to determine whether any connections are no longer needed and can be disconnected.

Event logging

Management > Event Logging displays the event log for the Digi device. This log records events throughout the Digi device's system, such as starting or resetting the Digi device, configuring features, actions performed by various interfaces and subsystems, starting applications, etc. The event log is always enabled and is not user-configurable. When the Digi device operates in an unexpected manner, the log entries can be set to Digi for analysis by Technical Support and Engineers. The events log cannot be turned off, so that Digi receives an accurate view of all aspects of the operation of the device.

The event log is maintained in RAM memory, and there is no history across reboots of the device. When the log "overflows" the oldest entries are overwritten with new ones, so the history is incomplete.

The **Clear** button clears the event log.

Manage network services

Management > Network Services displays information about active network services. Currently, the only network-service management task possible from this page is managing the DHCP server.

Manage DHCP server operation

DHCP server management operations include:

- View DHCP server status.
- Start/stop/restart the DHCP server.
- View and manage current DHCP leases.

Start, stop, and restart the DHCP server

The DHCP Server Management page shows the current status of the DHCP server. Depending on the current status, there are buttons to start, stop, or restart the DHCP server. Click the appropriate button to perform your request.

Note Stopping, restarting, or rebooting the DHCP server causes all information on IP address leases to be lost. All leased addresses except for reservations will be returned to the available address pool and may be served in a new lease to a DHCP client.

View and manage current DHCP leases

The DHCP server maintains a current list of its leases, reservations and unavailable addresses. The displayed lease list may contain entries that report a variety of status descriptions. The Lease Status types are identified and described below.

Even after a lease has expired or is released by a DHCP client, the associated IP address is not immediately returned to the available address pool. Rather, there is a non-configurable **grace period** during which the lease record is retained by the DHCP server. At the end of that grace period, the lease record is automatically deleted and the associated IP address is returned to the available address pool. Where a grace period is observed, this is indicated in the Lease Status descriptions below.

The grace period is incorporated in the DHCP server to increase the consistency of offering the same IP address to a DHCP client, even if that client is rebooted or off the network for a period of time that does not exceed the grace period.

Leases can be removed from the DHCP server while the server is running. To remove a lease, select the checkbox to the left of the lease information in the table of leases, then click the **Remove** button below the lease table. To remove all leases, select the checkbox to the left of the descriptive headings at the top of the table, then click the **Remove** button below the lease table.

Note Removing a lease will cause the associated IP address to be returned immediately to the available address pool. Any IP address in this available address pool may be served in a new lease to a DHCP client. Static lease reservations will always display in the lease list. These reservation leases may be removed, but a new lease will be created immediately. To disable or permanently remove a reservation, use the DHCP server Settings page in the Network Configuration area.

Lease status types

Here are the Lease Status values that are displayed in the lease list, including how long a lease table entry will remain in each state. Note that after a lease is deleted, the associated IP address is returned to the available address pool.

- **Assigned (active):** A lease is currently assigned and active for the given client. The client may renew the lease, in which case the lease remains in this state.
- **Assigned (expired):** A lease has expired and is no longer active for the given client. A lease in this state will remain for a 4 hour grace period, after which it is deleted. If the same client requests an IP address before the lease is deleted, it will be given the same IP address previously served to it.
- **Reserved (active):** A lease for an address reservation is currently active for the given client. A reservation lease will remain indefinitely, although the status may alternate between active and inactive.
- **Reserved (inactive):** A lease for an address reservation is currently inactive for the given client. A reservation lease will remain indefinitely, although the status may alternate between active and inactive.
- **Reserved (unavail):** A lease for an address reservation was offered to a client, but that client actively declined to use the IP address. Typically this is because the client determined that another host on the same subnetwork is already using that IP address. Upon receiving the client's decline message, the DHCP server will mark the address as unavailable. The lease will remain in this state for 4 hours, after which it reverts to the Reserved (inactive) status.
- **Offered (pre-lease):** A lease has been offered to the given client, but that client has not yet requested that the lease be acknowledged. It may be that the client also received an offer from another DHCP server, in which case this offer will expire in approximately 2 minutes. If the client requests this lease before that 2 minute interval elapses, this lease will change status to Assigned. If the 2 minute interval expires, the offer record is deleted and the associated IP address is returned immediately to the available address pool.
- **Released:** A lease was previously assigned to the given client, but that client has proactively released it. A lease in this state will remain for a 1 hour grace period, after which it is deleted. If the same client requests an IP address before the lease is deleted, it will be given the same IP address previously served to it.
- **Unavailable Address:** A lease was offered to a client, but that client actively declined to use the IP address. Typically this is because the client determined that another host on the same subnetwork is already using that IP address. Upon receiving the client's decline message, the DHCP server will mark the address as unavailable. The lease will remain in this state for a 4 hour grace period, after which it is deleted. This status may also occur if the DHCP server determines that the IP address is in use before it offers the address to a client (see the DHCP server setting **Check that an IP address is not in use before offering it**).

Monitoring capabilities from the command line

There are several commands for monitoring Digi devices and managing their connections. For complete descriptions of these commands, see the *Digi Connect Family Command Reference*.

Commands for displaying device information and statistics

display commands

display commands display real-time information about a device, such as:

- General product information, including the product name, MAC address, boot, post, and firmware versions, memory usage, utilization, and uptime, or the amount of time since the device was booted (**display device**).
- Active interfaces on the system, for example, the web interface, command line interface, Point to Point Protocol (PPP), and Ethernet interface, and their status, such as “Closed” or “Connected.” (**display netdevice**).
- The event log (**display logging**).
- Memory usage information (**display memory**).
- Serial modem signals. (**display serial**).
- Mobile connection information and statistics (**display mobile**).
- Network Address Translation (NAT) information (**display nat**).
- General status of the sockets resource (**display sockets**).
- Active TCP sessions and active TCP listeners (**display tcp**).
- Current UDP listeners (**display udp**).
- Point-to-Point Protocol (PPP) information, including results of Link Integrity Monitoring tests by Digi SureLink “**display pppstats**”).
- Provisioning information currently in the Digi device device’s CDMA module (**display provisioning**).
- Uptime information (**display uptime**).
- Virtual Private Network (VPN) connection information (**display vpn**).

info commands

info commands displays statistical information about a device over time. The statistics displayed are those gathered since the tables containing the statistics were last cleared. Statistics include:

- Device statistics. **info device** displays such details as product, MAC address, boot, POST, and firmware versions, memory usage, utilization, and uptime.
- Ethernet statistics. **info ethernet** displays statistics regarding the Ethernet interface, including the number of bytes and packets sent and received, the number of incoming and outgoing bytes that were discarded or that contained errors, the number of Rx overruns, the number of times the transmitter has been reset, and the number of incoming bytes when the protocol was unknown.
- ICMP statistics. **info icmp** displays the number of messages, bad messages, and destination unreachable messages received.
- Serial statistics. **info serial** displays the number of bytes received and transmitted, signal changes, FIFO and buffer overruns, framing and parity errors, and breaks detected.
- TCP statistics. **info tcp** displays the number of segments received or sent, the number of active and passive opens, the number of bad segments received, the number of failed connection attempts, the number of segments retransmitted, and the number of established connections that have been reset.
- UDP statistics. **info udp** displays the number of datagrams received or sent, bad datagrams received, and the number of received datagrams that were discarded because the specified port was invalid.
- To display mobile statistics, use **display mobile** instead of **info**.

set alarm

set alarm displays alarm settings, including conditions that trigger alarms, and how alarms are sent, either as an email message, an SNMP trap, or both. Alarms can be reconfigured as needed.

set buffer and display buffers

set buffer configures buffering parameters on a port and displays the current port buffer configuration. **display buffers** displays the contents of a port buffer, or transfers the port-buffer contents to a server running Trivial File Transfer Protocol (TFTP).

set snmp

set snmp configures SNMP, including SNMP traps, such as authentication failure, cold start, link up, and login traps, and displays current SNMP settings.

show

The **show** commands display current settings in a device.

Commands for managing connections and sessions

- **close**: Closes active sessions that were opened by **connect**, **rlogin**, and **telnet** commands.
- **connect**: Makes a connection, or establishes a connection, with a serial port.
- **dhcp**: Manages DHCP server operation.
- **exit** and **quit**: These commands terminate a currently active session.
- **vpn**: Manages Virtual Private Network (VPN) connections.
- **who** and **kill**: The **who** command displays a global list of connections. The list of connections includes those associated with a serial port or the command-line interface. **who** is particularly useful in conjunction with the **kill** command, which terminates active connections. Use **who** to determine any connections that are no longer needed, and end the connections by issuing a **kill** command.
- **mode**: Changes or displays the operating options for a current Telnet session.
- **ping**: Tests whether a host or other device is active and reachable.
- **reconnect**: Reestablishes a previously established connection; that is, a connection opened by a **connect**, **rlogin**, or **telnet** command; the default operation is to reconnect to the last active session.
- **rlogin**: Performs a login to a remote system.
- **send**: Sends a Telnet control command, such as **break**, **abort output**, **are you there**, **escape**, or **interrupt process**, to the last active Telnet session.
- **status**: Displays a list of sessions, or outgoing connections made by **connect**, **rlogin**, or **telnet** commands for a device. Typically, the **status** command is used to determine which of the current sessions to close.
- **telnet**: Makes an outgoing Telnet connection, also known as a session.

Commands for managing XBee networks and nodes

Several commands are used to configure XBee networks and display information and statistics about the devices in the network: **set xbee**, **display xbee**, **xbee**, and **info zigbee_sockets**.

- The **set xbee** command configures XBee network settings for a ConnectPort X gateway. Also displays current configuration parameters on the gateway xbee node or of remote nodes in the xbee (specified by the **address** option).
- The **display xbee** command refreshes the display of XBee network devices, and displays specific information about XBee network devices. Information displayed includes the node address and ID list, as well as individual node status.
- The **xbee** command executes an XBee utility or displays the status of actions performed by the XBee utilities. Actions include displaying information about the XBee network setup, sending loopback data, displaying the status of XBee firmware, and scheduling XBee firmware updates.
- The **info zigbee_sockets** command displays statistics about XBee device sockets and data communications activity on an XBee network. These statistics show what is happening on the XBee network from the ConnectPort X gateway's perspective; essentially data from the XBee module's perspective as interpreted by the XBee driver in the gateway.

Monitoring Capabilities from SNMP

Device monitoring capabilities from SNMP include, among other things:

- Network statistics, defined in RFC 1213, MIB-II
- Port statistics, defined in RFCs 1316 and 1317
- Device information, defined in Digi enterprise MIB DIGI-DEVICE-INFO.mib

For more information on the statistics available through the standard RFCs listed above, refer to the RFCs available on the IETF web site (www.ietf.org). For enterprise MIBs, refer to the description fields in the MIB text.

Digi device administration

C H A P T E R 5

This chapter discusses the administration tasks that need to be performed on Digi devices periodically, such as file management, changing the password used for logging onto the device, backing up and restoring device configurations, updating firmware and Boot/POST code, restoring the device configuration to factory defaults, and rebooting the device. As with device configuration and monitoring, it covers performing administrative tasks through a variety of device interfaces, including web and command-line interfaces.

Administration from the web interface

The Administration section of the web interface main menu provides the following choices:

- **File Management:** For uploading and managing files, such as custom web pages, applet files, and initialization files. See "File management" on page 211.
- **Python Program File Management:** For uploading custom programs in the Python programming language to Digi devices and configuring the programs to execute automatically at startup. See "Python® program management" on page 171.
- **X.509 Certificate/Key Management:** For loading and managing X.509 certificates and public/private host key pairs that are public key infrastructure (PKI) based security. See page 212.
- **Backup/Restore:** For backing up or restoring a device's configuration settings. See "Backup/restore device configurations" on page 215.
- **Update Firmware:** For updating firmware, including Boot and POST code. See "Update firmware and Boot/POST Code" on page 216.
- **Factory Default Settings:** For restoring a device to factory default settings. See "Restore a device configuration to factory defaults" on page 217.
- **System Information:** For displaying general system information for the device and device statistics. See "Display system information" on page 220.
- **Reboot:** For rebooting the device. See "Reboot the Digi device" on page 220.

These administrative tasks are organized elsewhere in the web interface:

- Enable and disable network services. See "Network services settings" on page 75.
- Enable password authentication for the Digi device. See "Security settings" on page 166.

File management

The **File Management** page of the web interface uploads custom files to a Digi device, such as the files for a custom applet, or a custom image file of your company logo. Custom applets allow the flexibility to alter the interface either by adding a different company logo, changing colors, or moving information to different locations. If custom applets or the sample Java applet is not used, using this feature is not necessary.

Uploading files

To upload files to a Digi device, enter the file path and name for the file, or click **Browse** to locate and select the file, and click **Upload**.

Delete files

To delete files from a Digi device, select the file from the list under **Manage Files** and click **Delete**.

Custom files are not deleted by device reset

Any files uploaded to the file system of a Digi device from the File Management page are not deleted by restoring the device configuration to factory defaults, or by pressing the Reset button on the device (see "Restore a device configuration to factory defaults" on page 217). This deletion is prevented so that customers with custom applets and custom factory defaults can retain them on the device and not have them deleted by a reset. Such files can only be deleted by the Delete operation, described above.

X.509 Certificate/Key Management

The X.509 Certificate/Key Management pages are for loading and managing X.509 certificates and public/private host key pairs that are public key infrastructure (PKI) based security. There are separate pages of settings for the certificate databases and key management.

Certificate Authorities (CAs) / Certificate Revocation Lists (CRLs)

The **Certificate Authority (CA) database** is used to load certificate authority digital certificates. A certificate authority (CA) is a trusted third party which issues digital certificates for use by other parties. Digital certificates issued by the CA contain a public key. The certificate also contains information about the individual or organization to which the public key belongs. A CA verifies digital certificate applicants' credentials. The CA certificate allows verification of digital certificates, and the information contained therein, issued by that CA.

The **Certificate Revocation List (CRL) database** is used to load certificate revocation lists for loaded CAs. A certificate revocation list (CRL) is a file that contains the serial numbers of digital certificates issued by a CA which have been revoked, and should no longer be trusted. Like CAs, CRLs are a vital part of a public key infrastructure (PKI). The digital certificate of the corresponding CA must be installed before the CRL can be loaded.

- **Upload Certificate Authority Certificates and Certificate Revocation Lists:** Use this section to upload certificate authority (CA) certificates, or certificate revocation list (CRL) files. Files may be in ASN.1 DER or PEM Base64 encoded formats.
- **Installed Certificate Authority Certificates:** Lists any certificate authority certificates that are loaded in the Certificate Authority database.
- **Installed Certificate Authority Certificate Revocation Lists:** Lists any certificate authority certificate revocation lists that are loaded in the Certificate Revocation List database.
- **Obtain CA certificates from a SCEP Server:** Use this section to specify the SCEP server from which CA certificates should be obtained. Note: Certificates must be accepted by the operator to be used for any purpose.
- **Installed SCEP Certificate Authority Certificates:** Lists any Simple Certificate Enrollment Protocol (SCEP) certificate authority certificates that are installed.

Virtual Private Network (VPN) Identities

The **Virtual Private Networking (VPN) Identities database** is used to load host certificates and keys. Identity certificates and keys allow for IPSec authentication and secure key exchange with ISAKMP/IKE using RSA or DSA signatures. The VPN identity certificate must be issued by a CA trusted by the peer.

- **Upload VPN Identity Keys and Certificates:** Use this section to upload VPN RSA or DSA identity keys and certificates. Identity certificate and key files may be in ASN.1 DER or PEM Base64 encoded formats. If the host key file is encrypted, a password is required.
- **Installed VPN Identity Certificates:** Lists any identity certificates that are loaded in the VPN Identities database.
- **Installed VPN Identity Keys:** Lists any identity keys that are in the VPN Identities database.
- **Key Generation / Enrollment:** Sets parameters for handling enrollment requests.
- **Pending SCEP Enrollment Requests:** lists Certificate Enrollment Protocol (SCEP) requests that are pending approval.

Secure Sockets Layer (SSL) / Transport Layer Security (TLS) Certificates

The **Secure Sockets Layer (SSL) and Transport Layer Security (TLS) databases** are used to load host certificates and keys, as well as peer certificates and revocations.

- **Identity Certificates and Keys**
 - **Upload SSL/TLS Identity Keys and Certificates:** use this section to upload SSL/TLS RSA or DSA identity keys and certificates. Identity certificate and key files may be in ASN.1 DER or PEM Base64 encoded formats. If the host key file is encrypted, a password is required.
 - **Installed SSL and TLS Identity Certificates:** lists the identity certificates that are installed in the SSL and TLS databases.
 - **Installed SSL/TLS Identity Keys:** Lists the identity keys that are installed in the SSL and TLS databases.
- **Trusted Peer Certificates**
 - **Upload SSL/TLS Trusted Peer Certificates:** Use this section to upload SSL/TLS trusted peer certificate files. Files may be in ASN.1 DER or PEM Base64 encoded formats.
 - **Installed SSL/TLS Trusted Peer Certificates:** Lists the trusted peer certificates that have been loaded into the SSL and TLS databases.
- **Untrusted Revoked Certificates**
 - **Upload SSL/TLS Untrusted Revoked Certificates:** Use this section to upload SSL/TLS untrusted revoked certificates to the database. Files may be in ASN.1 DER or PEM Base64 encoded formats.
 - **Installed SSL/TLS Untrusted Revoked Certificates:** Lists the untrusted revoked certificates that have been loaded into the SSL and TLS databases

Secure Shell (SSH) Hostkeys

The **Secure Shell (SSHv2) Hostkeys database** is used to load host private keys. SSHv2 host keys are used for authentication with SSHv2 clients and secure key exchange. A default 1024-bit DSA key is generated automatically if none exists when the device boots.

- **Upload SSH Host Keys:** Use this section to upload SSH RSA or DSA hostkeys. Key files may be in ASN.1 DER or PEM Base64 encoded formats. If the host key file is encrypted, a password is required.
- **Installed SSH Host Keys:** Lists the host keys that have been loaded into the SSH Hostkeys database.

Backup/restore device configurations

Once a Digi device is configured, backing up the configuration settings is recommended in case problems occur later, firmware is upgraded, or hardware is added. If multiple devices need to be configured, the backup/restore feature can be used as a convenience, where the first device's configuration settings is backed up to a file, then the file is loaded onto the other devices.

This procedure shows how to back up or restore the configuration to a server and download a configuration from a server to a file or TFTP.

If using TFTP, ensure that the TFTP program is running on a server.

In the web interface:

- 1 From the Main menu, click **Administration > Backup/Restore**. The Backup/Restore page is displayed.
- 2 Choose the appropriate option (**Backup** or **Restore**) and select the file.

Update firmware and Boot/POST Code

The firmware and/or boot/POST code for a Digi device can be updated from a file on a PC or through TFTP. The recommended method is to download the firmware to a local hard drive. TFTP is supported for those using UNIX systems. Both the firmware and the boot/POST code are updated using the same set of steps. The Digi device automatically determines the type of image being uploaded. Before uploading the firmware or the boot/POST code, it is very important to read the Release Notes supplied with the firmware to check if the boot/POST code must be updated before updating the firmware.

Prerequisites

These procedures assume that:

- A firmware file has already been downloaded from digi.com.
- If using TFTP, that the TFTP server is running.

Update firmware from a file on a PC

- 1 From the Main menu, click **Administration** > **Update Firmware**. The Update Firmware page is displayed.
- 2 Enter the name of the firmware or POST file in the **Select Firmware** edit box, or click **Browse** to locate and select the firmware or POST file.
- 3 Click **Update**.
Important: DO NOT close the browser until the update is complete and a reboot prompt has been displayed.

Update Firmware from a TFTP Server

Updating firmware from a TFTP server is done from the command-line interface using the **boot** command. It cannot be done from the web interface. For details, see "Administration from the command-line interface" on page 221.

Restore a device configuration to factory defaults

Restoring a Digi device to its factory default settings clears all current configuration settings except the IP address settings and host key settings. In addition, any files that were loaded into the device through the File Management page such as custom-interface files and applet files are retained. See "File management" on page 211 for information on loading and deleting files.

There are two ways to reset the device configuration of a Digi device to the factory default settings: from the web interface and using the reset button or, in some cases, the reset signal, on the Digi device.

Settings cleared and retained during factory reset

The **Restore Factory Defaults** operation clears all current settings *except* the IP address settings and host key settings. This is the best way to reset the configuration, because the settings can also be backed up using the Backup/Restore operation, which provides a means for restoring it after the configuration issues have been resolved.

Using the web interface

- 1 Make a backup copy of the configuration using the Backup/Restore operation, described on page 215.
- 2 From the Main menu, click **Administration > Factory Default Settings**. The Factory Default Settings page is displayed.
- 3 Choose whether to keep the network settings for the device, such as the IP address, and click **Restore**.

Using the Reset button

If the Digi device cannot be accessed from the web interface, the configuration can be restored to factory defaults by using the Reset button.

- 1 Power off the Digi device.
- 2 Locate the Reset button or pin on your device.

ConnectPort X2 and ConnectPort X4 models have the reset button is on the side panel.
 ConnectPort X4 H has no reset button.

ConnectPort X2

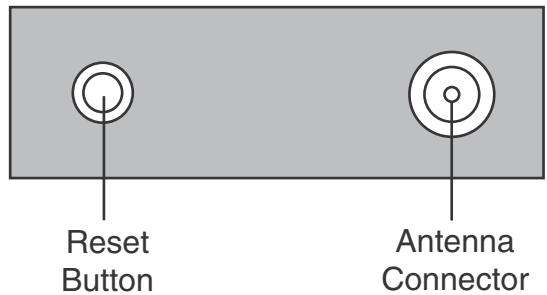

ConnectPort X4

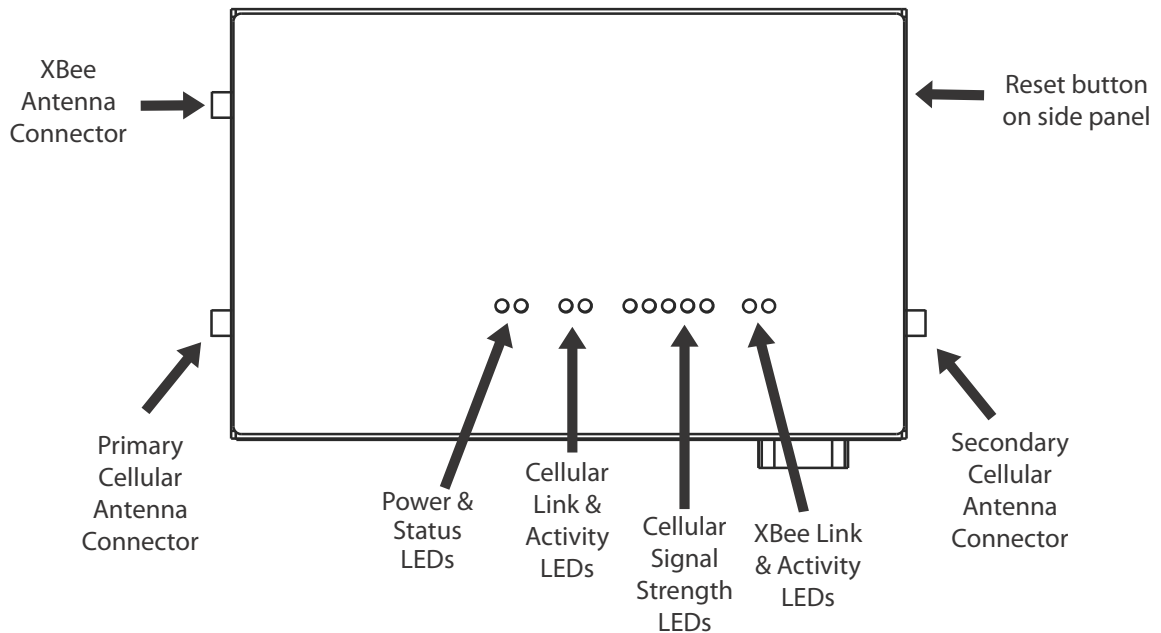

ConnectPort X8 has the reset button on the front panel.

ConnectPort X8 - Front

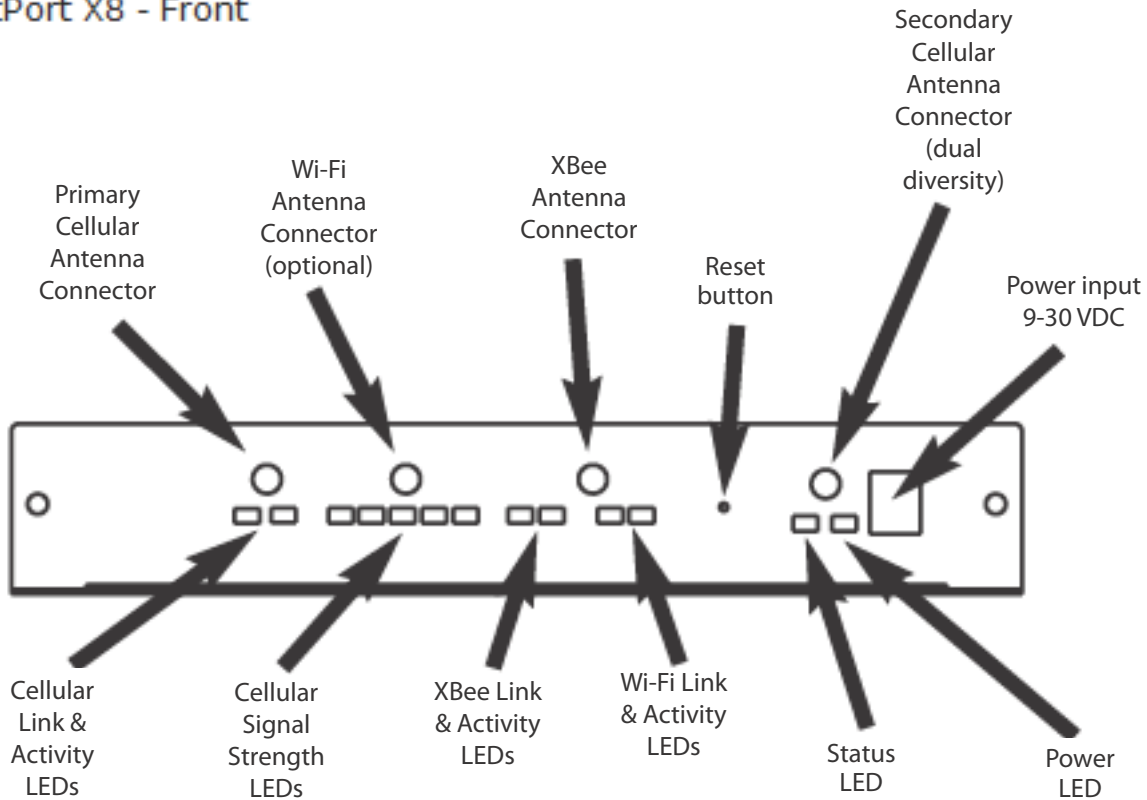

- 3 Hold the **Reset** button down gently with a non-conductive, small diameter tool (such as wood or plastic) with a blunt end (NOT SHARP or the button could be damaged). Power on the device while holding the Reset button down.
- 4 After a few seconds you may see a 1-1-1 blink once on some devices.
- 5 Wait until you see the Status LED blink a 1-5-1 pattern, then release the reset button.
- 6 Wait for the device to boot up. At this time, the configuration is returned to factory defaults.
- 7 Now, if desired, power off the device, though this is not necessary. Powering off the device before releasing the button guarantees the configuration will NOT be reverted. Powering off the device just after releasing the button will result in an unknown configuration, possibly having some or all settings reverted to defaults.

Display system information

System information displays the model, MAC address, firmware version, boot version, and POST version of the Digi device. It also displays memory available: total, used, and free, and tracks CPU percent utilization and the uptime.

From the web interface menu, select **Administration > System Information**. Select **General**, **Serial**, **Network**, or **Diagnostics** for the appropriate information. For descriptions of the information displayed on these screens, see page 184.

Reboot the Digi device

Changes to some device settings require saving the changes and rebooting the Digi device. To reboot a Digi device:

- 1 From the web interface menu, select **Administration > Reboot**.
- 2 On the **Reboot** page, click the **Reboot** button. Wait approximately 1 minute for the reboot to complete.

Enable/disable access to network services

As needed, enable and disable access to various network services, such as ADDP, RealPort, SNMP, and Telnet. For example, for performance and security reasons, it may be desirable to disable access to all network services not necessary for running or interfacing with the Digi device. In the web interface, enabling and disabling network services is done on the **Network Services** settings page for a Digi device. See "Network services settings" on page 75.

Administration from the command-line interface

Administrative tasks for Digi devices can also be performed from the command line. Here are several device-administration tasks and the commands used to perform them. See the *Digi Connect Family Command Reference* for more complete command descriptions.

| Administrative task | Command |
|--|--|
| Backup/restore a configuration from a TFTP server on the network | backup |
| Update firmware | boot Telnet to the Digi device's command line interface using a telnet application or hyperterm. If security is enabled for the Digi device, a login prompt is displayed. The default username is "root" and the default password is "dbps." If these defaults do not work, contact the system administrator who set up the device. Issue the command: #> boot load= <i>tftp-server-ip:filename</i> where <i>tftp-server-ip</i> is the IP address of the TFTP server that contains the firmware, and <i>filename</i> is the name of the file to upload. |
| Reset configuration to factory defaults | revert or boot action=factory |
| Display system information and statistics | info |
| Reboot the device | boot |
| Enable/disable network services | set service |

Specifications and certifications

.....

C H A P T E R 6

This chapter provides hardware specifications, additional feature detail, and regulatory statements and certifications for Digi devices.

Hardware specifications

ConnectPort X2 specifications

| Specification | | Value |
|--------------------|--------------------------------------|---|
| Environmental | Ambient temperature | -40 to 185F (-40 to 85 C) |
| | Relative humidity | 5 to 95% (non-condensing) |
| | Storage and transport temperature | -40 to 185F (-40 to 85C) |
| | Altitude | 6560 feet (2000 meters) |
| | Ethernet isolation | 1500VAC min per IEEE802.3/ANSI X3.263 |
| Power requirements | DC power input | <p>ConnectPort X2 Industrial (metal enclosure):</p> <ul style="list-style-type: none"> ■ 9-30VDC ■ Power consumption: Idle: 0.6 W Max: 1.8 W For ConnectPort X2 XTend/XStream variants: Idle: 0.2 W; Max: 9.9 W ■ Connector: 2.35mm x 5.7mm, locking barrel, center pin positive. <p>ConnectPort X2 Commercial (plastic enclosure):</p> <ul style="list-style-type: none"> ■ 5VDC ■ Power consumption: Idle: 0.6 W Max: 1.8 W ■ Connector: 2.35mm x 5.7mm, barrel, center pin positive. |
| | AC power supply (domestic SKUs) | <p>Can be powered by an external power supply.</p> <ul style="list-style-type: none"> ■ Certifications: UL /c-UL Listed ITE (LPS) or Class II power supply ■ Input voltage: 120 VAC +/- 10% ■ Input frequency: 60 Hz ■ Output voltage: 12 VDC +/- 5% ■ Max output current: 500 mA ■ Temperature range: +32 to 104F (0 to 40C). ■ Connector: 2.1mm x 5.5mm, locking barrel, center pin positive. |
| | AC power supply (international SKUs) | <ul style="list-style-type: none"> ■ Certifications: CE/UL /c-UL Listed ITE or Class II power supply ■ Input voltage: 100 VAC to 240 VAC ■ Input frequency: 50-60 Hz ■ Output voltage: 12 VDC +/- 5% ■ Max output current: 1.66 A ■ Temperature range: +32 to 104F (0 to 40C). ■ Connector: 2.1mm x 5.5mm, locking barrel, center pin positive. |

| Specification | | Value |
|---------------|--------|---|
| Dimensions | Length | <ul style="list-style-type: none">■ 4.5 in (11.4 cm)■ For ConnectPort X2 XTend/XStream variants: 6.2 in (15.75 cm) |
| | Width | 2.75 in (7.0 cm) |
| | Height | 1.125 in (2.9 cm) |
| | Weight | 0.44 lb (0.20 kg) |

ConnectPort X4 specifications

| Specification | | Value |
|--------------------|-----------------------------------|---|
| Environmental | Ambient temperature | +32F to 104F (0 to +40C) <ul style="list-style-type: none"> ■ The ambient temperature of the unit may be further limited by the ambient temperature limits of the internal modules. ■ The ambient temperature of the internal modules must not be exceeded for proper operation. Refer to the installed module's specifications. |
| | Relative humidity | 5 to 95% (non-condensing) |
| | Storage and transport temperature | -40 to 185F (-40 to 85C) |
| | Altitude | 6560 feet (2000 meters) |
| | Ethernet isolation | 1500VAC min per IEEE802.3/ANSI X3.263 |
| Power requirements | DC power input | <ul style="list-style-type: none"> ■ Voltage input: 6-30VDC ■ Power consumption: Idle: 1.5W Max: 10.4W ■ Connector: 2.35mm x 5.7mm, locking barrel, center pin positive. |
| | AC power supply | <ul style="list-style-type: none"> ■ Certifications: CE/UL /c-UL Listed ITE (LPS) or Class II power supply ■ Input voltage: 100 VAC to 240 VAC ■ Input frequency: 50-60 Hz ■ Output voltage: 12 VDC +/- 5% ■ Max output current: 1.66 A ■ Temperature range: +32 to 104F (0 to 40C) ■ Connector: 2.1mm x 5.5mm, locking barrel, center pin positive. |
| Dimensions | Length | 5.25 in (13.3 cm) |
| | Width | 3.35 in (8.5 cm) |
| | Depth | 0.97 in (2.5 cm) |
| | Weight | 2.60 lb (1.18 kg) |

ConnectPort X4 H specifications

| Specification | | Value |
|----------------------|-----------------------------------|---|
| Environmental | Ambient temperature | -40F to 140F (-40C to +60C) |
| | Relative humidity | 5 to 95% (non-condensing) |
| | Storage and transport temperature | -40F to 185F (-40C to 85C) |
| | Altitude | 6560 feet (2000 meters) |
| | Ethernet isolation | 1500VAC min per IEEE802.3/ANSI X3.263 |
| | IP rating | IP66 |
| Power requirements | DC power input | <ul style="list-style-type: none"> ■ Voltage input: 6-30VDC ■ Power consumption: Idle: 1.5W Max: 10.4W ■ Connector: 2.35mm x 5.7mm, locking barrel, center pin positive. |
| | AC power supply | <ul style="list-style-type: none"> ■ Certifications: CE/UL /c-UL Listed ITE (LPS) or Class II power supply ■ Input voltage: 100 VAC to 240 VAC ■ Input frequency: 47-63 Hz ■ Max input watts: 25W max ■ Power: US power cord or European cord option |
| Dimensions | Length | 9.5 in (24.13 cm) |
| | Width | 6.25 in (15.88 cm) |
| | Depth | 3.5 in (8.89 cm) |
| | Weight | 3.2 pounds (1.45 kg) |
| Mounting orientation | | The ConnectPort X4 H should be mounted to a flat, secure surface with the cable strain release facing downward. |

ConnectPort X8 specifications

| Specification | | Value |
|--------------------|-----------------------------------|--|
| Environmental | Ambient temperature | +32F to 104F (0 to +40C) |
| | Relative humidity | 5 to 95% (non-condensing) |
| | Storage and transport temperature | -40F to 185F (-40 to 85C) |
| | Altitude | 6560 feet (2000 meters) |
| | Ethernet isolation | 1500VAC min per IEEE802.3/ANSI X3.263 |
| Power requirements | DC power input | <ul style="list-style-type: none"> ■ Voltage input: 9-30VDC ■ Power consumption: Idle: 1.2W Max: 3.4W ■ Connector: 2.35mm x 5.7mm, locking barrel, center pin positive. |
| | AC power supply | <ul style="list-style-type: none"> ■ Certifications: CE/UL /c-UL Listed ITE (LPS) or Class II power supply ■ Input voltage: 100 VAC to 240 VAC ■ Input frequency: 50-60 Hz ■ Output voltage: 12 VDC +/- 5% ■ Max output current: 1.66 A ■ Temperature range: +32 to 104F (0 to 40C). ■ Connector: 2.1mm x 5.5mm, locking barrel, center pin positive. |
| Dimensions | Length | 7.75 in (19.7 cm) |
| | Width | 4.11 in (10.40 cm) |
| | Height | 1.30 in (3.30 cm) |
| | Weight | Without a module: 1.40 lb (0.64 kg) With a module: 1.50 lb (0.68 kg) |

Wireless networking features

The following table shows key wireless-networking features that can be configured in Wi-Fi-enabled Digi products. For more details and up-to-date information on support of these features, see the readme file for your Digi product.

| Wireless feature | Description |
|--|--|
| Standard | 802.11bg |
| Frequency | 2.4 GHz |
| Data Rates | Up to 54 Mbps with automatic rate fallback |
| Modulation | DBPSK (1 Mbps), DQPSK (2 Mbps), CCK (11, 5.5 Mbps), BPSK (6, 9 Mbps), QPSK (12, 18 Mbps), 16-QAM (24, 36 Mbps), 64-QAM (48, 54 Mbps) |
| Country Code | Specifies the country in which the product is used. |
| Network Mode | <ul style="list-style-type: none"> ■ Open ■ Infrastructure Mode ■ Ad-Hoc Mode |
| Channel | Can use automatic channel search-and-select or a user-configurable channel number. |
| Service Set Identifier (SSID) | A user-configurable SSID string or auto-connect option. |
| Wireless Security | <ul style="list-style-type: none"> ■ Wi-Fi Protected Access (WPA/WPA2/802.11i) ■ Wired Equivalent Privacy (WEP) |
| Authentication Options | <ul style="list-style-type: none"> ■ Open ■ Shared ■ Wi-Fi Protected Access (WPA2--/802.11i) ■ WPA/WPA2 with pre-shared key (WPA-PSK) |
| 802.1x (WPA2--/802.11i) Authentication | <ul style="list-style-type: none"> ■ LEAP (WEP), PEAP, TTLS, TLS, EAP-FAST ■ GTC, MD5, OTP, PAP, CHAP, MSCHAP, MSCHAPv2, TTLS-MSCHAPv2 |
| Encryption | <ul style="list-style-type: none"> ■ Temporal Key Integrity Protocol (TKIP) ■ Counter mode CBC MAC Protocol (CCMP) ■ Wired Equivalent Privacy (WEP) ■ Use of encryption can be disabled. |
| Network Key | A shared key (ASCII or Hexadecimal) to be used for WEP or WPA-PSK. |
| Username | A username to be specified when 802.1x -based authentication (WPA) is used. |
| Password | A password to be specified when 802.1x based authentication (WPA) is used. |

| Wireless feature | Description |
|--|---|
| EkahauClient™ | Provides integrated support for Ekahau's Wi-Fi device-location solution. Ekahau offers a complete access point vendor-independent real-time location system for wireless LAN devices that is capable of pinpointing wireless LAN devices such as the Digi Connect products, laptops, PDAs, or other intelligent Wi-Fi enabled devices. The solution provides floor-, room- and door-level accuracy of up to 3.5 feet (1 m). The patented Ekahau positioning technology is based on simple signal-strength calibration maps, and enables customers to fully leverage an existing wireless LAN infrastructure without any need for proprietary hardware components. |
| Wireless Networking Status Features: | The following status information can be displayed for Wireless Digi devices. For more detailed descriptions, see “WiFi LAN statistics” on page 190. |
| Connection Status | The status of the wireless network connection. |
| Network Mode | The network mode currently in use: <ul style="list-style-type: none"> ■ Infrastructure Mode ■ Ad-Hoc Mode |
| Data Transfer Rate | The data transfer rate of the current connection. |
| Channel | The wireless network channel currently in use. |
| SSID | The selected SSID of the wireless network. |
| Wireless Security: Wi-Fi Protected Access (WPA/WPA2/802.11i), Wired Equivalent Privacy (WEP) security and encryption | The status of the WEP/WPA/WPA2 security features, including the Authentication Method currently in use and whether authentication is enabled or disabled |
| Signal Strength | A statistic that indicates the strength of the radio signal between 0 and 100 percent. |

Regulatory information and certifications

FCC certifications and regulatory information (USA only)

FCC Part 15 Class B

These devices comply with the standards cited in this section:

- ConnectPort X2
- ConnectPort X4
- ConnectPort X8
- ConnectPort X5 R

Radio Frequency Interface (RFI) (FCC 15.105)

This device has been tested and found to comply with the limits for Class B digital devices pursuant to Part 15 Subpart B, of the FCC rules. These limits are designed to provide reasonable protection against harmful interference in a residential environment. This equipment generates, uses, and can radiate radio frequency energy, and if not installed and used in accordance with the instruction manual, may cause harmful interference to radio communications. However, there is no guarantee that interference will not occur in a particular installation. If this equipment does cause harmful interference to radio or television reception, which can be determined by turning the equipment off and on, the user is encouraged to try and correct the interference by one or more of the following measures:

- Reorient or relocate the receiving antenna.
- Increase the separation between the equipment and receiver.
- Connect the equipment into an outlet on a circuit different from that to which the receiver is connected.
- Consult the dealer or an experienced radio/TV technician for help.

Labeling Requirements (FCC 15.19)

This device complies with Part 15 of FCC rules. Operation is subject to the following two conditions: (1) this device may not cause harmful interference, and (2) this device must accept any interference received, including interference that may cause undesired operation.

If the FCC ID is not visible when installed inside another device, then the outside of the device into which the module is installed must also display a label referring to the enclosed module FCC ID.

Modifications (FCC 15.21)

Changes or modifications to this equipment not expressly approved by Digi may void the user's authority to operate this equipment.

Declaration of Conformity

(In accordance with FCC Dockets 96-208 and 95-19)

Manufacturer's Name: Digi International
Corporate Headquarters: 11001 Bren Road East
 Minnetonka MN 55343
Manufacturing Headquarters: 10000 West 76th Street
 Eden Prairie MN 55344

Digi International declares, that the product:

| Product Name | Model Number |
|---------------------|----------------------------|
| ConnectPort X2 | 50001527-xx 50001531-xx |
| ConnectPort X4 | 50001513-xx |
| ConnectPort X4 H | 50001513-xx |
| ConnectPort X8 | 50001358-xx |

to which this declaration relates, meets the requirements specified by the Federal Communications Commission as detailed in the following specifications:

- Part 15, Subpart B, for Class B equipment
- FCC Docket 96-208 as it applies to Class B personal computers and peripherals

The product listed above has been tested at an External Test Laboratory certified per FCC rules and has been found to meet the FCC, Part 15, Class B, Emission Limits. Documentation is on file and available from the Digi International Homologation Department.

Industry Canada (IC) certifications

This digital apparatus does not exceed the Class B limits for radio noise emissions from digital apparatus set out in the Radio Interference Regulations of the Canadian Department of Communications.

Le present appareil numerique n'emet pas de bruits radioelectriques depassant les limites applicables aux appareils numeriques de la class B prescrites dans le Reglement sur le brouillage radioelectrique edicte par le ministere des Communications du Canada.

Safety statements

5.10 Ignition of Flammable Atmospheres

Warnings for Use of Wireless Devices



Observe all warning notices regarding use of wireless devices.

Potentially Hazardous Atmospheres

Observe restrictions on the use of radio devices in fuel depots, chemical plants, etc. and areas where the air contains chemicals or particles, such as grain, dust, or metal powders, and any other area where you would normally be advised to turn off your vehicle engine.

Safety in Aircraft

Switch off the wireless device when instructed to do so by airport or airline staff. If the device offers a 'flight mode' or similar feature, consult airline staff about its use in flight.

Safety in Hospitals

Wireless devices transmit radio frequency energy and may affect medical electrical equipment. Switch off wireless devices wherever requested to do so in hospitals, clinics, or healthcare facilities. These requests are designed to prevent possible interference with sensitive medical equipment.

Pacemakers

Pacemaker manufacturers recommended that a minimum of 15cm (6 inches) be maintained between a handheld wireless device and a pacemaker to avoid potential interference with the pacemaker. These recommendations are consistent with independent research and recommendations by Wireless Technology Research.

Persons with Pacemakers:

- Should ALWAYS keep the device more than 15cm (6 inches) from their pacemaker when turned ON.
- Should not carry the device in a breast pocket.
- If you have any reason to suspect that the interference is taking place, turn OFF your device.

Class I Division 2, Groups A,B,C,D Hazardous Location

The following models are suitable for use in Class I, Division 2, Groups A, B, C and D or Non-hazardous locations only.

- ConnectPort X4 S2 2G Term
- ConnectPort X4 H

Warning: Explosion Hazard - Substitution of components may impair suitability for Class I, Division 2.

Avertissement: Risque d'Explosion - La substitution de composants peut rendre ce matériel inacceptable pour les emplacements de Classe I, Division 2.

Warning: Explosion Hazard - Do not replace power supply unless power has been switched off or the area is known to be non-hazardous.

Avertissement: Risque d'Explosion - Ne remplace power supply pas d'alimentation électrique à moins que le pouvoir n'ait été éteint ou on connu que la région soit non-hazardueuse.

Warning: Explosion Hazard - Do not disconnect equipment unless power has been switched off or the area is known to be non-hazardous.

Avertissement: Risque d'Explosion - Avant de déconnecter l'équipement, couper le courant ou s'assurer que l'emplacement est désigné non dangereux.

International EMC (Electromagnetic Emissions/Immunity/Safety) standards

This device complies with the requirements of following Electromagnetic Emissions/Immunity/Safety standards:

| Product | Emissions | Immunity | Safety |
|------------------|---|---|---|
| ConnectPort X2 | EN55022 CISPR22 AN/NZS CISPR22 FCC Part 15 Subpart B Class B ICES-003 | EN55024 | IEC/EN60950-1 |
| ConnectPort X4 | EN55022:2006 AS/NZS CISPR 22:2006 ICES-003 FCC Part 15 Subpart B Class B | EN55024:1998+A1:2001+A2:2003 | IEC/EN60950-1 UL 60950-1 CSA C22.2 No. 60950-1-03 |
| ConnectPort X4 H | EN55022:2006 AS/NZS CISPR 22:2006 ICES-003 FCC Part 15 Subpart B Class B | EN55024:1998+A1:2001+A2:2003 EN61000-6-2:2005; radiated immunity tested to 10V | IEC/EN60950-1 UL 60950-22 (outdoor version) CSA C22.2 No. 60950-1-03 UL1604, Class 1 Div 2 Haz Loc (pending) |
| ConnectPort X8 | EN55022:1994 +A1:1995+A2:1997 As/NZS CISPR 22:2004 ICES-003 FCC Part 15 Subpart B class B | EN55024:1998+A1:2001+A2:2003 | UL 60950-1 IEC/EN60950-1 CSA C22.2 No. 60950-1-03 |

Troubleshooting

C H A P T E R 7

This chapter provides information on resources and processes available for troubleshooting your Digi device.

Troubleshooting Resources

There are several resources available to you for support of your Digi product or resolving configuration difficulties at Digi's Support site, <http://www.digi.com/support/> Try these troubleshooting steps to eliminate your problem. After working through these steps and your problem is not solved, try the resources listed below.

- 1 Visit Digi's Support knowledge bases at <http://www.digi.com/support/kbase> to look for articles related to your situation.
- 2 Visit our Support Forums at <http://www.digi.com/support/forum/> and search for possible posts from other users with similar situations.
- 3 If the knowledge base or support forums do not have the information you need, fill out an Online Support Request via <http://www.digi.com/support/eservice/login.jsp?p=true>. You will need to create a user account if one is not already set up.

System status LEDs

Digi devices have several LEDs that indicate system status, link integrity, and link activity.

ConnectPort X2 LEDs and buttons

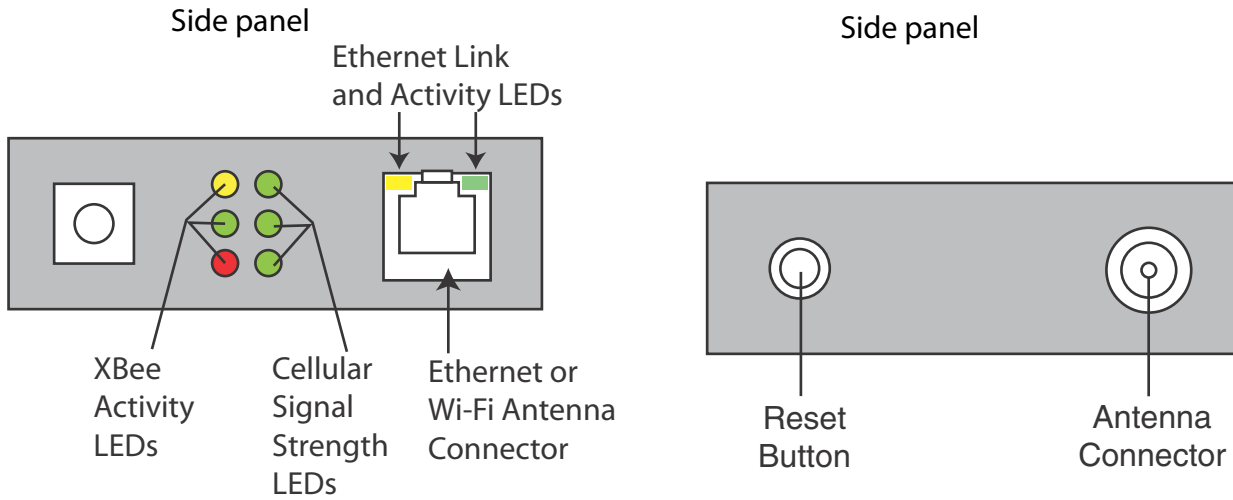

ConnectPort X2 LEDs and buttons

| LED/button | Color and Light Pattern | Description |
|-------------------------------|-------------------------|---|
| XBee Network Activity LEDs | | Indicate network communications activity for the XBee RF module in the gateway: For more information on this indicator, see the description of the D5 (DIO5 Configuration) parameter in the product manual for the RF module. |
| | Yellow (top LED) | Serial Data Out (to host) |
| | Green (middle) | Serial Data In (from host) |
| | Red (bottom) | Associate/Power Indicator. Indicates both power to the interface board and the network association status for the RF module in the interface board. |
| | Solid red | RF module powered and not associated to a ZigBee network. |
| | Blinking red | RF module has associated to a ZigBee network. |
| Cellular Signal Strength LEDs | | Relative signal strength indicator (RSSI), shown as a number of LEDs. <ul style="list-style-type: none"> ■ 0: signal strength unknown or unacceptable ■ 1: signal strength low/weak ■ 3: signal strength high/excellent Specific dB values for the signal can be found via the web interface; go to Administration > System Information > Mobile . Under Mobile Connection, the signal strength is displayed in bars and dBm. Or, from the command line, enter the display mobile command. |
| Ethernet Link LED | Solid yellow | Ethernet link is up. |
| Ethernet Activity LED | Blinking green | Ethernet traffic is on the link. |
| Reset button | | Single press: Performs equivalent of a power-cycle. Press and hold: Resets device configuration settings to factory defaults (factory reset). |

ConnectPort X4 LEDs and buttons

ConnectPort X4 - Top

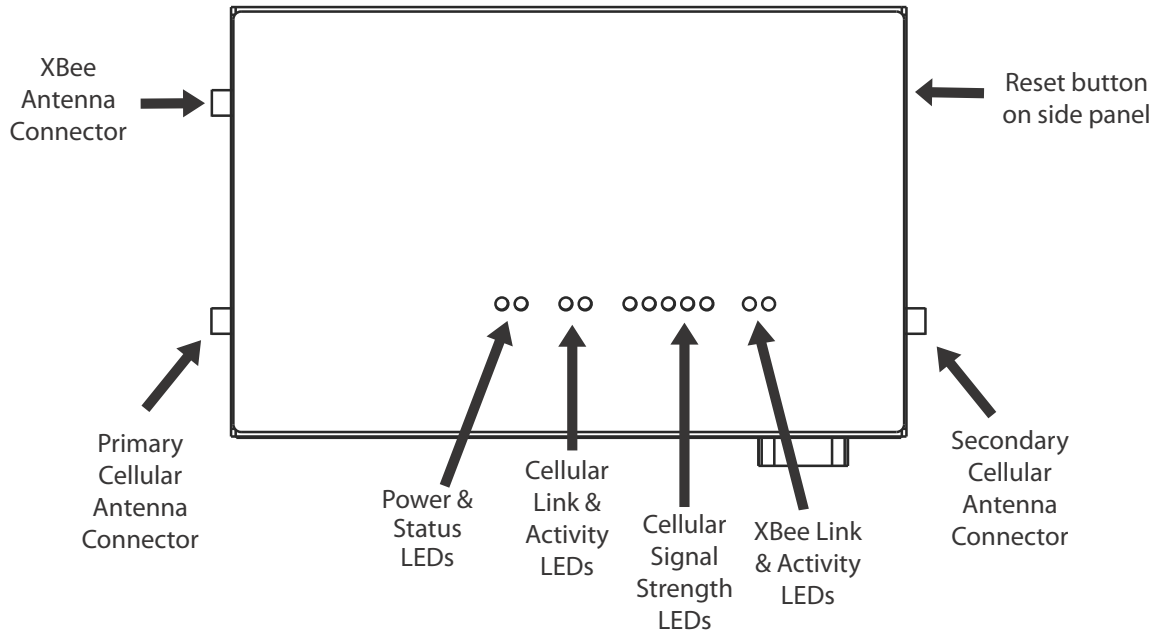

ConnectPort X4 - Front panel

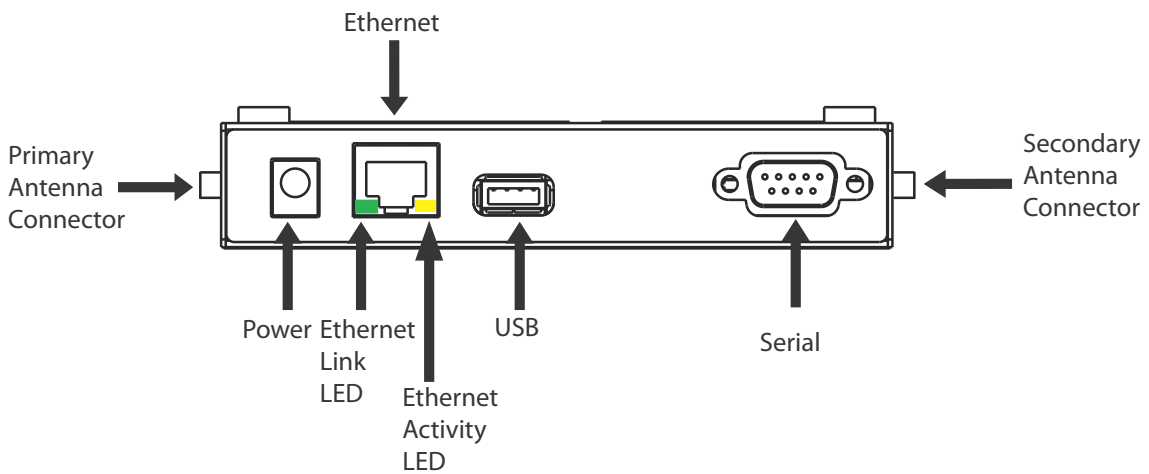

ConnectPort X4 H LEDs

Top Panel

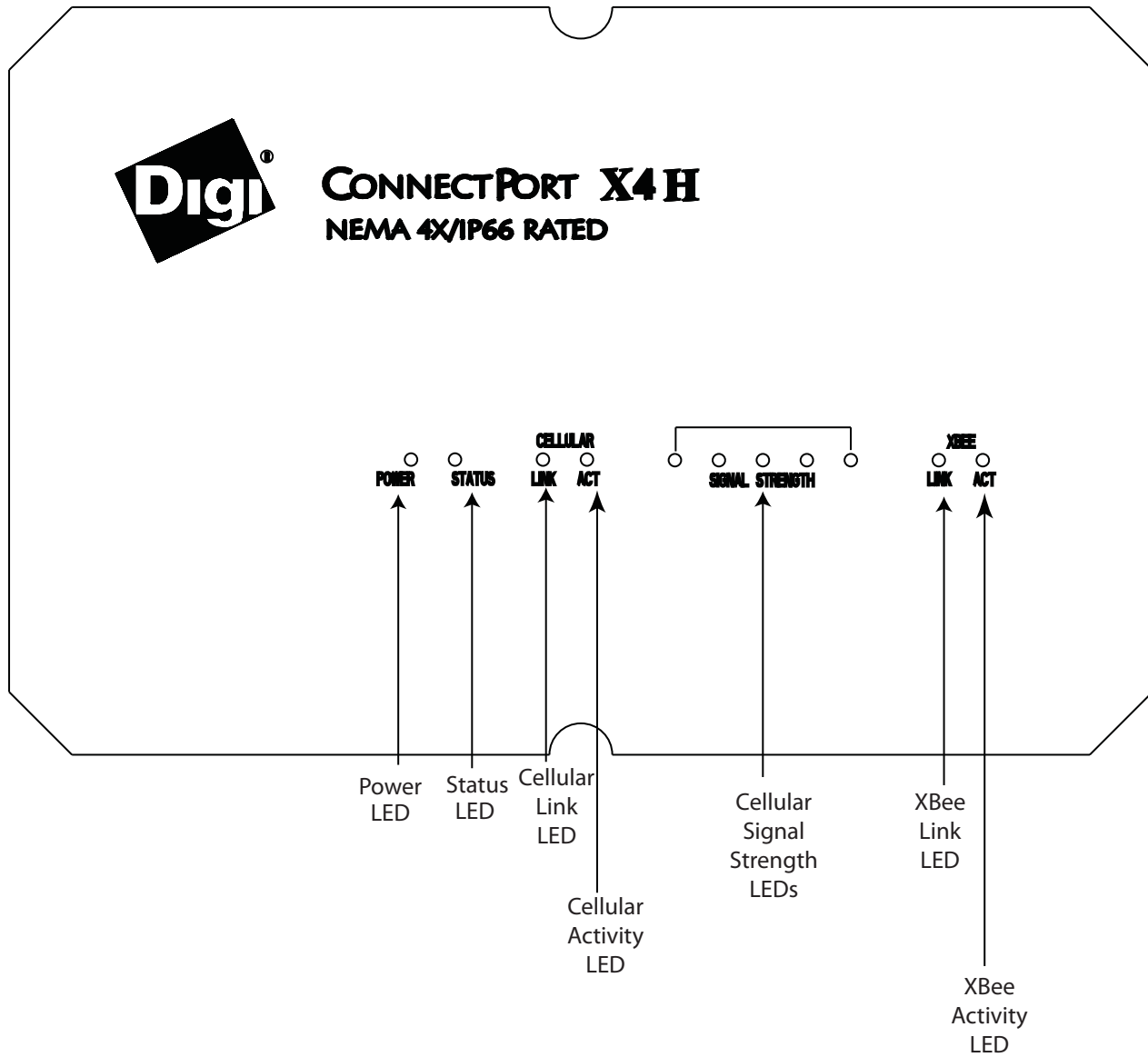

ConnectPort X4 and ConnectPort X4 H LEDs and buttons

| LED/button | Color and Light Pattern | Description |
|-------------------------------|-----------------------------|--|
| Power LED | Green | Power is applied. |
| | Not illuminated | No power. |
| Status LED | Yellow | Blinks during product initialization and factory reset, using the light patterns below. During normal device operation after initialization and factory reset, this LED is off and should never blink. If it blinks constantly, contact Digi Technical Support. |
| | 1-1-1 blinking yellow | Firmware is initializing. |
| | 1-5-1 blinking yellow | Device configuration has been restored to its factory defaults. |
| | Other blinking yellow | Contact Digi Technical Support. |
| Cellular Link LED | Solid yellow | Cellular link is up. |
| Cellular Activity LEDs | Blinking green | Cellular traffic is on the link. |
| Cellular Signal Strength LEDs | Blue | <p>Relative signal strength indicator (RSSI), shown as a number of LEDs.</p> <ul style="list-style-type: none"> ■ 0: signal strength unknown or unacceptable ■ 1: signal strength low/weak ■ 5: signal strength high/excellent <p>Specific dB values for the signal can be found via the web interface; go to Administration > System Information > Mobile. Under Mobile Connection, the signal strength is displayed in bars and dBm. Or, from the command line, enter the display mobile command.</p> |
| XBee Link LED | Green | Indicates that the XBee RF module in the gateway has associated with an XBee network: For more information on this indicator, see the description of the D5 (DIO5 Configuration) parameter in the product manual for the XBee module. |
| | Solid green | XBee module in gateway is associated (or coordinator is started). |
| | Fast blinking (20 Hz) green | An Ident (identify) button has been pressed on a remote node. |
| | Slow (1 Hz) blinking green | XBee module in gateway is not associated. |
| | Off | XBee module in gateway is disabled or not recognized. |

ConnectPort X4 and ConnectPort X4 H LEDs and buttons

| LED/button | Color and Light Pattern | Description |
|---|-------------------------|--|
| XBee Activity LED | Yellow | On for 25 ms when data is sent or received from the XBee module in the gateway. |
| Ethernet Link LED | Solid yellow | Ethernet link is up. |
| Ethernet Activity LED | Blinking green | Ethernet traffic is on the link. |
| Reset button (ConnectPort X4 model only) | N/A | <p>Single press: Performs equivalent of a power-cycle.</p> <p>Press and hold: Resets device configuration settings to factory defaults (factory reset).</p> <p>There is no reset button on the ConnectPort X4 H.</p> |

ConnectPort X8 LEDs and buttons

ConnectPort X8 - Front

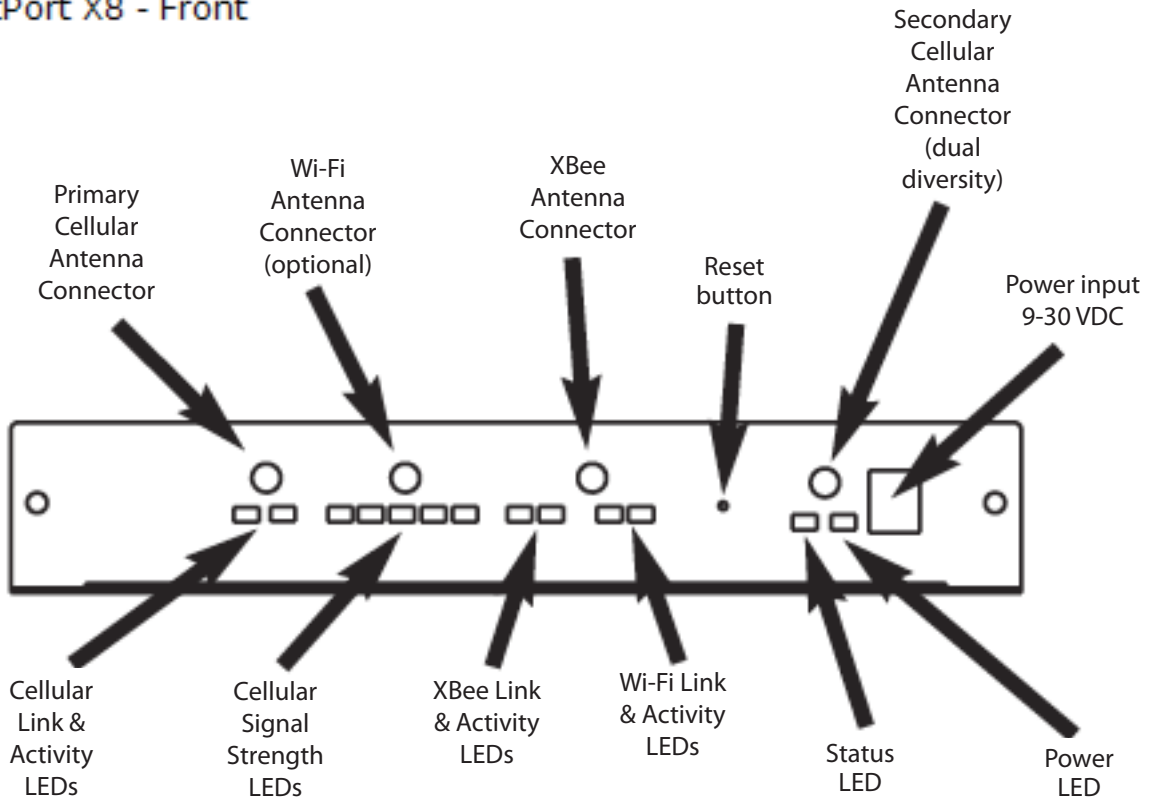

ConnectPort X8 - Back

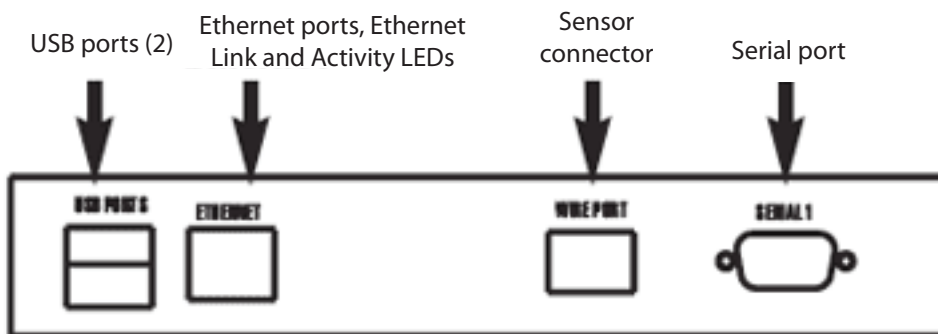

ConnectPort X8 LEDs and buttons

| LED/button | Color and Light Pattern | Description |
|-------------------------------|-------------------------|--|
| Power LED | Green | Power is applied. |
| | Not illuminated | No power. |
| Status LED | | Blinks during product initialization and factory reset, using the light patterns below. This LED should never blink during normal operation. If it blinks constantly, contact Digi Technical Support. |
| | Solid red | Hardware is initializing. |
| | 1-1-1 blinking green | Firmware is initializing. |
| | 1-5-1 blinking green | Device configuration has been restored to its factory defaults. |
| | Other blinking green | Contact Digi Technical Support. |
| | Solid green | Device is powered on and ready for operation. |
| Ethernet Link LED | Solid yellow | Ethernet link is up. |
| Ethernet Activity LED | Blinking green | Ethernet traffic is on the link. |
| Cellular Link LED | Solid yellow | Cellular link is up. |
| Cellular Activity LEDs | Blinking green | Cellular traffic is on the link. |
| Cellular Signal Strength LEDs | Blue | <p>Relative signal strength indicator (RSSI), shown as a number of LEDs.</p> <ul style="list-style-type: none"> ■ 0: signal strength unknown or unacceptable ■ 1: signal strength low/weak ■ 5: signal strength high/excellent <p>Specific dB values for the signal can be found via the web interface; go to Administration > System Information > Mobile. Under Mobile Connection, the signal strength is displayed in bars and dBm. Or, from the command line, enter the display mobile command.</p> |
| XBee Link | Off | Gateway is disabled. |
| | Solid green | XBee RF module in the gateway has started or joined an XBee network. |
| | Blinking green | XBee RF module in the gateway has not started or joined an XBee network. |

ConnectPort X8 LEDs and buttons

| LED/button | Color and Light Pattern | Description |
|-------------------------------|-------------------------|---|
| XBee Activity | Off | There is no XBee network activity |
| | Blinking yellow | Serial data is being sent between the XBee RF module and the gateway. For more information on this indicator, see the description of the D5 (DIO5 Configuration) parameter in the product manual for the XBee RF module. |
| Wi-Fi Link | Solid yellow | Wi-Fi link is up. |
| Wi-Fi Activity | Blinking green | Wi-Fi traffic is on the link. |
| Cellular Signal Strength LEDs | Green | Relative signal strength indicator (RSSI), shown as a number of LEDs. <ul style="list-style-type: none"> ■ 0: signal strength unknown or unacceptable ■ 1: signal strength low/weak ■ 3: signal strength high/excellent Specific dB values for the signal can be found via the web interface; go to Administration > System Information > Mobile . Under Mobile Connection, the signal strength is displayed in bars and dBm. Or, from the command line, enter the display mobile command. |
| Reset button | | Single press: Performs equivalent of a power-cycle. Press and hold: Resets device configuration settings to factory defaults (factory reset). |

Glossary

802.11

The IEEE standard for wireless Local Area Networks. It uses three different physical layers, 802.11a, 802.11b and 802.11g.

access control list

See IP filtering.

Address Resolution Protocol (ARP)

A protocol for mapping an Internet Protocol address () to a physical machine address that is recognized in the local network.

Advanced Digi Discovery Protocol (ADDP)

A protocol that runs on any operating system capable of sending multicast IP packets on a network. ADDP allows the system to identify all ADDP-enabled Digi devices attached to a network by sending out a multicast packet. The Digi devices respond to the multicast packet and identify themselves to the client sending the multicast.

alarms

Used to send emails or issue SNMP traps when certain device events occur. These events include certain data patterns being detected in the data stream, and, for cellular-enabled Digi devices, cellular alarms for signal strength and amount of cellular traffic for a given period of time.

autoconnection

A network connection initiated from a Digi device that is based on timing, serial activity, or serial modem signals.

Auto-IP

A standard protocol that automatically assigns an IP address from a reserved pool of standard Auto-IP addresses to the computer on which it is installed. The device is set to obtain its IP address automatically from a Dynamic Host Configuration Protocol (DHCP) server. But if the DHCP server is unavailable or nonexistent, Auto-IP will assign the device an IP address. If DHCP is enabled or responds later or you use ADDP, both will override the Auto-IP address previously assigned.

CDMA

CDMA (Code-Division Multiple Access) protocols are used in wireless communications. CDMA is a form of multiplexing, which allows numerous signals to occupy a single transmission channel, optimizing the use of available bandwidth. The technology is used in ultra-high-frequency (UHF) cellular telephone systems in the 800-MHz and 1.9-GHz bands and through an analog-to-digital conversion enhances privacy and makes cloning difficult.

CLI

Command-line interface.

COM port redirection

The process of establishing a connection between the host and networked serial devices by creating a local COM or TTY port on the host. See also RealPort.

configuration management

Managing the files and settings that contain device configuration information. Configuration management tasks include copying device configuration files to and from a remote host, upgrading device firmware, and resetting the device configuration to factory defaults.

coordinator

In XBee networks, a coordinator is node that has the unique function of forming a network. The coordinator is responsible for establishing the operating channel and PAN ID for an entire network. Once established, the coordinator can form a network by allowing routers and end devices to join to it. Once the network is formed, the coordinator functions like a router (it can participate in routing packets and be a source or destination for data packets). Characteristics of coordinators include:

- One Coordinator per PAN
- Establishes/Organizes PAN
- Can route data packets to/from other nodes
- Can be a data packet source and destination
- Mains-powered

In the web interface, a coordinator is also referred to as a *gateway device*.

CTS

Clear to Send.

device server

A one- or two-port intelligent network device that converts serial data into network data.

Digi Device Setup Wizard

A wizard for configuring Digi devices that is available from the Digi Support site and on the Software and Documentation CD shipped with each Digi device. The Digi Device Setup Wizard is available in Microsoft Windows or UNIX platforms. It assigns an IP address for the device, configures the device based on your description of the device environment, and determines whether you need to install RealPort. Using the Digi Device Setup Wizard is the recommended and preferred method for configuration.

DSR

Data Set Ready.

DTR

Data Terminal Ready.

Dynamic Host Configuration Protocol (DHCP)

An Internet protocol for automating the configuration of computers that use TCP/IP. DHCP can be used to automatically assign IP addresses, to deliver TCP/IP stack configuration parameters such as the subnet mask and default router, and to provide other configuration information.

EIA

See Electronics Industry Association.

Electronics Industry Association (EIA) and Electronics Industries Alliance (EIA)

1) The Electronic Industries Association (EIA) comprises individual organizations that together have agreed on certain data transmission standards such as EIA/TIA-232 (formerly known as RS-232).

2) The Electronics Industries Alliance (EIA) is an alliance of trade organizations that lobby in the interest of companies engaged in the manufacture of electronics-related products.

Encapsulating Security Payload (ESP)

A routing protocol used to route (tunnel) various types of information between networks. See also ESP Passthrough.

encryption

The conversion of data into a form, called a ciphertext, that cannot be easily understood by unauthorized people. Decryption is the process of converting encrypted data back into its original form, so it can be understood. Encryption/decryption is especially important in wireless communications. This is because wireless circuits are easier to tap than their hard-wired counterparts.

end device

In mesh ZigBee networks, end devices are network devices that have no routing capacity. They must always interact with their parent node (router or coordinator) to transmit or receive data. An end device can be a source or destination for data packets but cannot route packets. End devices can be battery-powered and offer low-power operation. Characteristics of end devices include:

- Several end devices can operate in one PAN
- Can be a data packet source and destination
- All messages are relayed through a coordinator or router
- Low power end devices are not supported in this release.

Enhanced Data Rates for Global Evolution (EDGE)

A faster version of the Global System for Mobile (GSM) wireless service, designed to deliver data at rates up to 384 Kbps and enable the delivery of multimedia and other broadband applications to mobile phone and computer users. The EDGE standard is built on the existing GSM standard, using the same time-division multiple access (TDMA) frame structure and existing cell arrangements.

ESP Passthrough

A method of carrying IP packets for a Virtual Private Network (VPN) setup. In ESP Passthrough, inbound IPsec ESP protocol traffic is forwarded from to a VPN device connected to the Digi device's Ethernet port.

Evolution-Data Optimized (EV-DO, EVDO, or 1xEV-DO)

A wireless radio broadband data standard adopted by many CDMA mobile phone service providers. It is standardized by 3GPP2, as part of the CDMA2000 family of standards. Compared to 1xRTT (CDMA2000 1x) networks, or GPRS and EDGE networks, 1xEV-DO is significantly faster.

factory defaults

The default configuration values that are set in a device at the factory.

File Transfer Protocol (FTP)

A standard Internet protocol that specifies the simplest way to exchange files between computers on the Internet.

HyperText Transfer Protocol (HTTP)

An application protocol in the TCP/IP suite that defines the rules for transferring files (text, graphic images, sound, video, and other multimedia files) on the World Wide web (WWW).

HyperText Transfer Protocol over Secure Socket Layer (HTTPS)

A secure message-oriented communications protocol designed for use in conjunction with HTTP. HTTPS encrypts and decrypts user page requests as well as the pages that are returned by the web server. HTTPS uses the Secure Socket Layer (SSL) as a sublayer.

Internet Control Message Protocol (ICMP)

A message control and error-reporting protocol between a host server and a gateway to the Internet. ICMP uses Internet Protocol (IP) datagrams, but the messages are processed by the IP software and are not directly apparent to the application user.

Internet Group Management Protocol (IGMP)

Internet Group Management Protocol (IGMP) provides a way for an Internet computer to report its multicast group membership to adjacent routers. Multicasting allows one computer on the Internet to send content to multiple other computers that have identified themselves as interested in receiving the originating computer's content. Multicasting can be used for such applications as updating the address books of mobile computer users in the field, sending out company newsletters to a distribution list, and “broadcasting” high-bandwidth programs of streaming media to an audience that has “tuned in” by setting up a multicast group membership.

IP filtering

A network configuration that can be enabled to establish rules allowing devices to permit or deny specific IP addresses, networks, or devices from connection access. Also known as access control list.

IPsec (Internet Protocol Security)

A framework for a set of protocols for security at the network or packet processing layer of network communication. Earlier security approaches have inserted security at the application layer of the communications model. IPsec is said to be especially useful for implementing virtual private networks and for remote user access through dial-up connection to private networks. An advantage of IPsec is that security arrangements can be handled without requiring changes to individual user computers.

IPsec provides two choices of security service: Authentication Header (AH), which essentially allows authentication of the sender of data, and Encapsulating Security Payload (ESP), which supports both authentication of the sender and encryption of data as well. The specific information associated with each of these services is inserted into the packet in a header that follows the IP packet header. Separate key protocols can be selected, such as the ISAKMP/Oakley protocol.

Internet Security Association and Key Management Protocol (ISAKMP)

A protocol that defines procedures and packet formats to establish, negotiate, modify and delete Security Associations (SAs). SAs contain all the information required for execution of various network security services, such as the IP layer services (such as header authentication and payload encapsulation), transport or application layer services, or self-protection of negotiation traffic. ISAKMP defines payloads for exchanging key generation and authentication data. These formats provide a consistent framework for transferring key and authentication data which is independent of the key generation technique, encryption algorithm and authentication mechanism.

ISAKMP is distinct from key exchange protocols in order to cleanly separate the details of security association management (and key management) from the details of key exchange. There may be many different key exchange protocols, each with different security properties. However, a common framework is required for agreeing to the format of SA attributes, and for negotiating, modifying, and deleting SAs. ISAKMP serves as this common framework.

joining

In mesh ZigBee networks, joining is the process of a node becoming part of a ZigBee PAN. A node becomes part of a network by joining to a coordinator or a router (that has previously joined to the network). During the process of joining, the node that allowed joining (the parent) assigns a 16-bit address to the joining node (the child).

MAC address

A unique network identifier. All network devices are required to have their own unique MAC address. The MAC address is on a sticker on your Digi device. The number is displayed as 12 hexadecimal digits, usually starting with 00:40:9D.

Management Information Base (MIB)

A formal description of a set of network objects that can be managed using the Simple Network Management Protocol (SNMP).

Mobile Device Provisioning Wizard

A wizard for provisioning Digi Cellular Family products. Provisioning configures the Digi Cellular Family device with the required configuration used to access the mobile network.

modem emulation

A serial port configuration where the port acts as a modem. The Digi device emulates modem responses to a serial device and seamlessly sends and receives data over an Ethernet network instead of a Public Switched Telephone Network (PSTN). The advantage for a user is the ability to retain legacy software applications without modification and use a less expensive Ethernet network in place of public telephone lines. Also known as pseudo-modem or pmodem.

NAT

NAT (Network Address Translation) is the translation of an Internet Protocol address () used in one network to a different IP address known in another network through a NAT table that does the global-to-local and local-to-global IP address mapping. This increases security since each outgoing or incoming request must go through a translation process that also authenticates the request or matches it to a previous request. NAT can be statically defined or it can be set up to dynamically translate from and to a pool of IP addresses. NAT also conserves on the number of global IP addresses needed and it uses a single IP address in its communication with the world.

Personal Area Network (PAN)

In mesh ZigBee networks, a PAN is a data communication network that includes a Coordinator and one or more routers/end devices. Network formation is governed by Network Maximum Depth, Maximum Child Routers and Maximum Children End Devices.

PEAP

See Protected Extensible Authentication Protocol.

port forwarding

A serial port configuration that sends data directly to a specific port instead of the path determined by the router based on traffic.

Power-On Self Test (POST)

When power is turned on, POST (Power-On Self-Test) is the diagnostic testing sequence that a computer's basic input/output system (or "starting program") runs to determine if the computer keyboard, random access memory, disk drives, and other hardware are working correctly. If the necessary hardware is detected and found to be operating properly, the computer begins to boot. If the hardware is not detected or is found not to be operating properly, the BIOS issues an error message which may be text on the display screen and/or a series of coded beeps, depending on the nature of the problem.

Protected Extensible Authentication Protocol (PEAP)

A protocol proposed for securely transporting authentication data, including passwords, over 802.11 wireless networks. PEAP makes it possible to authenticate wireless LAN clients without requiring them to have certificates, simplifying the architecture of secure wireless LANs.

provisioning

The process of configuring a mobile (cellular) device with the required configuration used to access the mobile network.

RealPort

Patented Digi software for COM port redirection. RealPort makes it possible to establish a connection between the host and networked serial devices by creating a local COM or TTY port on the host. The COM/TTY port appears and behaves as a local port to the PC or server. This process of COM port redirection allows existing software applications like DNP3 and Modbus to work without modification. Unlike other COM port redirectors, RealPort offers full hardware and software flow control, as well as tunable latency and throughput. These features ensure optimum performance, since data transfer is adjusted according to specific application requirements.

remote login (rlogin)

A remote login to a Digi device's command-line interface (CLI). rlogin is a Unix command that allows an authorized user to login to other UNIX machines (hosts) on a network and to interact as if the user were physically at the host computer. Once logged in to the host, the user can do anything that the host has given permission for, such as read, edit, or delete files.

remote shell (rsh)

A Berkeley Unix networking command to execute a given command on a remote host, passing it input and receiving its output. Rsh communicates with a daemon on the remote host.

rlogin

See remote login.

RSSI

Relative Signal Strength Indicator.

RTS

Ready to Send.

RXD

Receiving Data.

Secure Sockets Layer (SSL)

A commonly-used protocol for managing the security of a message transmission on the Internet. SSL has recently been succeeded by Transport Layer Security (TLS), which is based on SSL.

serial bridge

A connection between two serial devices over a network that acts as if they were connected over a serial cable. Also known as serial tunneling.

serial tunneling

See serial bridge.

Setup Wizard

See Digi Device Setup Wizard.

Short Message Service (SMS)

A technology that enables the sending and receiving of messages between mobile devices. The data that can be held by an SMS message is very limited. One SMS message can contain at most 140 bytes (1120 bits) of data, or up to 160 characters if 7-bit character encoding is used, and up to 70 characters if 16-bit Unicode UCS2 character encoding is used.

Simple Mail Transfer Protocol (SMTP)

A TCP/IP protocol used in sending and receiving e-mail. Since it is limited in its ability to queue messages at the receiving end, it is usually used with one of two other protocols, POP3 or IMAP, that let the user save messages in a server mailbox and download them periodically from the server. SMTP usually is implemented to operate over Internet port 25. An alternative to SMTP that is widely used in Europe is X.400. Many mail servers now support Extended Simple Mail Transfer Protocol (ESMTP), which allows multimedia files to be delivered as e-mail.

Simple Network Management Protocol (SNMP)

A protocol for managing and monitoring network devices. The SNMP architecture enables a network administrator to manage nodes--servers, workstations, routers, switches, hubs, etc.--on an IP network; manage network performance, find and solve network problems, and plan for network growth.

static IP address assignment

The process of assigning a specific IP address to a device. Contrast with assigning a device through Dynamic Host Configuration Protocol (DHCP), or Automatic Private IP Addressing (APIPA or Auto-IP).

Telnet

A user command and an underlying TCP/IP protocol for accessing remote computers. On the web, HTTP and FTP protocols allow you to request specific files from remote computers, but not to actually be logged on as a user of that computer. With Telnet, you log on as a regular user with whatever privileges you may have been granted to the specific application and data on that computer.

Transmission Control Protocol (TCP)

A set of rules used along with the Internet Protocol (IP) to send data in the form of message units between computers over the Internet. While IP handles the actual delivery of the data, TCP handles keeping track of the individual units of data (called packets) that a message is divided into for efficient routing through the Internet. For example, when an HTML file is sent to you from a web server, the TCP program layer in that server divides the file into one or more packets, numbers the packets, and then forwards them individually to the IP program layer. Although each packet has the same destination IP address, it may get routed differently through the network. At the other end (the client program in your computer), TCP reassembles the individual packets and waits until they have arrived to forward them to you as a single file. TCP is known as a connection-oriented protocol, which means that a connection is established and maintained until such time as the message or messages to be exchanged by the application programs at each end have been exchanged. TCP is responsible for ensuring that a message is divided into the packets that IP manages and for reassembling the packets back into the complete message at the other end. In the Open Systems Interconnection (OSI) communication model, TCP is in layer 4, the Transport Layer.

Transport Layer Security (TLS)

A protocol that ensures privacy between communicating applications and their users on the Internet. When a server and client communicate, TLS ensures that no third party may eavesdrop or tamper with any message. TLS is the successor to the Secure Sockets Layer (SSL).

Trivial File Transfer Protocol (TFTP)

An Internet software utility for transferring files that is simpler to use than the File Transfer Protocol (FTP) but less capable. It is used where user authentication and directory visibility are not required. TFTP uses the User Datagram Protocol (UDP) rather than the Transmission Control Protocol (TCP). TFTP is described formally in Request for Comments (RFC) 1350.

TTY port redirection

The process of establishing a connection between the host and networked serial devices by creating a local TTY port on the host. The TTY port appears and behaves as a local port to the PC or server. See also RealPort

TXD

Transmit eXchange Data.

Universal Mobile Telecommunications Service (UMTS)

A third-generation (3G) broadband, packet-based transmission of text, digitized voice, video, and multimedia at data rates up to 2 megabits per second (Mbps) that offers a consistent set of services to mobile computer and phone users no matter where they are located in the world. Based on the Global System for Mobile (GSM) communication standard, UMTS, endorsed by major standards bodies and manufacturers, is the planned standard for mobile users around the world and is at present still being made available. Once UMTS is fully available geographically, computer and phone users can be constantly attached to the Internet as they travel and, as they roam, have the same set of capabilities no matter where they travel to. Users will have access through a combination of terrestrial wireless and satellite transmissions. Until UMTS is fully implemented, users can have multi-mode devices that switch to the currently available technology (such as GSM 900 and 1800) where UMTS is not yet available.

Today's cellular telephone systems are mainly circuit-switched, with connections always dependent on circuit availability. A packet-switched connection, using the Internet Protocol (IP), means that a virtual connection is always available to any other end point in the network. It will also make it possible to provide new services, such as alternative billing methods (pay-per-bit, pay-per-session, flat rate, asymmetric bandwidth, and others). The higher bandwidth of UMTS also promises new services, such as video conferencing. UMTS promises to realize the Virtual Home Environment (VHE) in which a roaming user can have the same services to which the user is accustomed when at home or in the office, through a combination of transparent terrestrial and satellite connections.

The electromagnetic radiation spectrum for UMTS has been identified as frequency bands 1885-2025 MHz for future IMT-2000 systems, and 1980-2010 MHz and 2170-2200 MHz for the satellite portion of UMTS systems.

User Datagram Protocol (UDP)

A communications protocol that offers a limited amount of service when messages are exchanged between computers in a network that uses the Internet Protocol (IP). UDP is an alternative to the Transmission Control Protocol (TCP) and, together with IP, is sometimes referred to as UDP/IP. Like TCP, UDP uses the Internet Protocol to actually get a data unit (called a datagram) from one computer to another. Unlike TCP, however, UDP does not provide the service of dividing a message into packets (datagrams) and reassembling it at the other end. Specifically, UDP does not provide sequencing of the packets in which the data arrives, nor does it guarantee delivery of data. This means that the application program that uses UDP must be able to make sure that the entire message has arrived and is in the right order. Network applications that want to save processing time because they have very small data units to exchange (and therefore very little message reassembling to do) may prefer UDP to TCP. The Trivial File Transfer Protocol (TFTP) uses UDP instead of TCP. UDP provides two services not provided by the IP layer. It provides port numbers to help distinguish different user requests and, optionally, a checksum capability to verify that the data arrived intact. In the Open Systems Interconnection (OSI) communication model, UDP, like TCP, is in layer 4, the Transport Layer.

web interface

The web-based interface for configuring, monitoring, and administering Digi devices.

ZigBee

A specification for wireless personal area networks (WPANs) operating at 868 MHz, 902-928 MHz, and 2.4 GHz. A WPAN is a personal area network (a network for interconnecting an individual's devices) in which the device connections are wireless. Using ZigBee, devices in a WPAN can communicate at speeds of up to 250 Kbps while physically separated by distances of up to 50 meters in typical circumstances and greater distances in an ideal environment. ZigBee is based on the 802.15 specification approved by the Institute of Electrical and Electronics Engineers Standards Association (IEEE-SA).

ZigBee provides for high data throughput in applications where the duty cycle is low. This makes ZigBee ideal for home, business, and industrial automation where control devices and sensors are commonly used. Such devices operate at low power levels, and this, in conjunction with their low duty cycle (typically 0.1 percent or less), translates into long battery life. Applications well suited to ZigBee include heating, ventilation, and air conditioning (HVAC), lighting systems, intrusion detection, fire sensing, and the detection and notification of unusual occurrences. ZigBee is compatible with most topologies including peer-to-peer, star network, and mesh networks, and can handle up to 255 devices in a single WPAN.