

AMMC-6241

26–43 GHz Low Noise Amplifier



Data Sheet



Chip Size: 1900 x 800 mm (74.8 x 31.5 mils)
Chip Size Tolerance: ± 10 mm (± 0.4 mils)
Chip Thickness: 100 ± 10 mm (4 ± 0.4 mils)
RF Pad Dimensions: 110 x 90 mm (4.3 x 3.5 mils)
DC Pad Dimensions: 100 x 100 mm (3.9 x 3.9 mils)

Description

Avago Technologies AMMC-6241 is a high gain, low-noise amplifier that operates from 26 GHz to 43 GHz. This LNA provides a wide-band solution for system design since it covers several bands, thus, reduces part inventory. The device has input / output match to 50 Ohm, is unconditionally stable and can be used as either primary or sub-sequential low noise gain stage. By eliminating the complex tuning and assembly processes typically required by hybrid (discrete-FET) amplifiers, the AMMC-6241 is a cost-effective alternative in the 26 - 43 GHz communications receivers. The backside of the chip is both RF and DC ground. This helps simplify the assembly process and reduces assembly related performance variations and costs. It is fabricated in a PHEMT process to provide exceptional noise and gain performance. For improved reliability and moisture protection, the die is passivated at the active areas.

Features

- Wide frequency range: 26 - 43 GHz
- High gain: 20 dB
- Low 50 Ω Noise Figure: 2.7 dB
- 50 Ω Input and Output Match
- Flat Gain Response
- Single 3V Supply Bias

Applications

- Microwave Radio systems
- Satellite VSAT, DBS Up/Down Link
- LMDS & Pt-Pt mmW Long Haul
- Broadband Wireless Access (including 802.16 and 802.20 WiMax)
- WLL and MMDS loops

AMMC-6241 Absolute Maximum Ratings ^[1]

Symbol	Parameters/Conditions	Units	Min.	Max.
V _d	Positive Drain Voltage	V		7
V _g	Gate Supply Voltage	V		NA
I _d	Drain Current	mA		100
P _{in}	CW Input Power	dBm		15
T _{ch}	Operating Channel Temp.	°C		+150
T _{stg}	Storage Case Temp.	°C	-65	+150
T _{max}	Maximum Assembly Temp (60 sec max)	°C		+300

Note: Operation in excess of any one of these conditions may result in permanent damage to this device.



Note: These devices are ESD sensitive. The following precautions are strongly recommended. Ensure that an ESD approved carrier is used when dice are transported from one destination to another. Personal grounding is to be worn at all times when handling these devices.

For more details, refer to Avago Technologies Application Note A004R: Electrostatic Discharge Damage and Control. ESD Machine Model (Class A) ESD Human Body Model (Class 0)

AMMC-6241 DC Specifications/Physical Properties [1]

Symbol	Parameters and Test Conditions	Units	Min.	Typ.	Max.
I_d	Drain Supply Current (under any RF power drive and temperature) ($V_d=3.0V$)	mA		60	80
θ_{ch-b}	Thermal Resistance ^[2] (Backside temperature, $T_b = 25^\circ C$)	$^\circ C/W$		25	

AMMC-6241 RF Specifications [3, 4, 5]

$T_A = 25^\circ C$, $V_d = 3.0V$, $I_{d(Q)} = 60mA$, $Z_{in} = Z_o = 50\Omega$

Symbol	Parameters and Test Conditions	Units	Minimum	Typical	Maximum	Sigma
Gain	Small-signal Gain ^[6]	dB	26-35 GHz = 20 35-40 GHz = 18.5	26-37 GHz = 21 37-40 GHz = 19.5		1.0
NF	Noise Figure into 50W	dB		26-37 GHz = 2.7 37-40 GHz = 3.0	26-37 GHz = 3.0 37-40 GHz = 3.3	0.05
P-1dB	Output Power at 1dB Gain Compression	dBm		+10		
OIP3	Third Order Intercept Point; Df=100MHz; Pin=-35dBm	dBm		+20		
RLin	Input Return Loss ^[6]	dB		-13	-11	0.40
RLout	Output Return Loss ^[6]	dB		-16	-12	0.50
Isol	Reverse Isolation ^[6]	dB		-40		0.50

Notes:

1. Ambient operational temperature $T_A = 25^\circ C$ unless otherwise noted.
2. Channel-to-backside Thermal Resistance (θ_{ch-b}) = $26^\circ C/W$ at $T_{channel} (T_c) = 34^\circ C$ as measured using infrared microscopy. Thermal Resistance at backside temperature (T_b) = $25^\circ C$ calculated from measured data.
3. Small/Large -signal data measured in wafer form $T_A = 25^\circ C$.
4. 100% on-wafer RF test is done at frequency = 30, 32, and 38 GHz.
5. Specifications are derived from measurements in a 50Ω test environment. Aspects of the amplifier performance may be improved over a more narrow bandwidth by application of additional conjugate, linearity, or low noise (Gopt) matching.
6. As derived from measured s-parameters

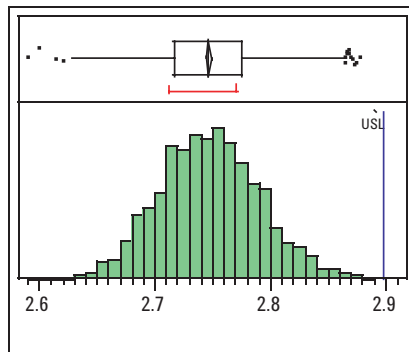

Noise Figure at 32 GHz

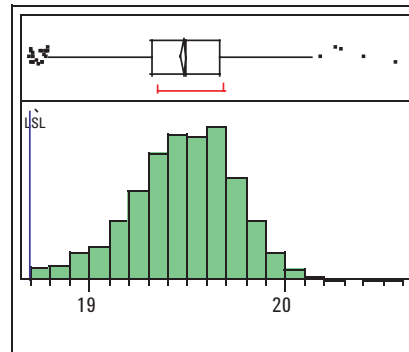

Gain at 38 GHz

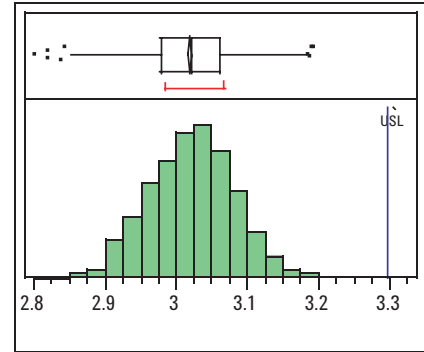

Noise Figure at 38GHz

Typical distribution of Small Signal Gain, Noise Figure, and Return Loss. Based on 1500 part sampled over several production lots.

AMMC-6241 Typical Performances

($T_A = 25^\circ\text{C}$, $V_{d1} = V_{d2} = 3.0\text{ V}$, $I_{\text{total}} = 60\text{ mA}$, $Z_{\text{in}} = Z_{\text{out}} = 50\ \Omega$ unless otherwise stated)

NOTE: These measurements are in a $50\ \Omega$ test environment. Aspects of the amplifier performance may be improved over a narrower bandwidth by application of additional conjugate, linearity, or low noise (Gopt) matching.

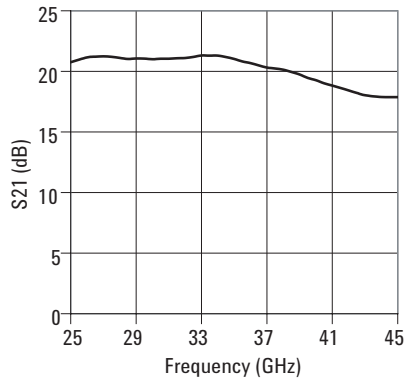

Figure 1. Typical Gain

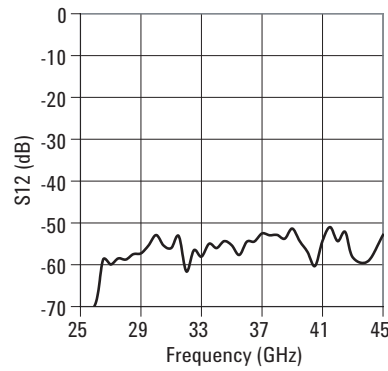

Figure 2. Typical Isolation

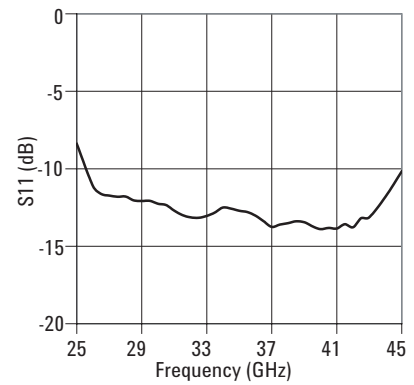

Figure 3 Typical Input Return Loss

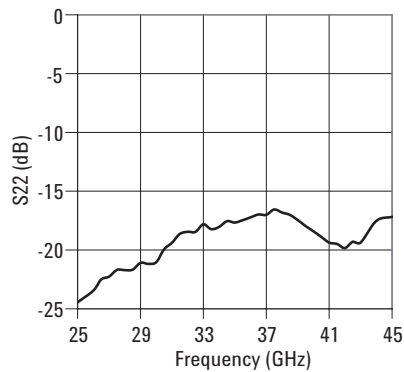

Figure 4. Typical Output Return Loss

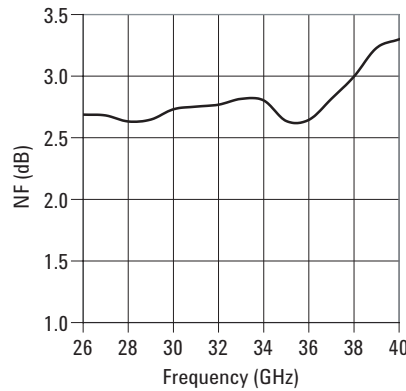

Figure 5. Typical Noise Figure into a $50\ \Omega$ load.

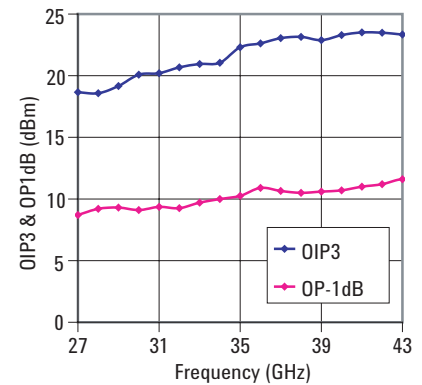

Figure 6. Typical Output $P_{-1\text{dB}}$ and 3rd Order Intercept Point.

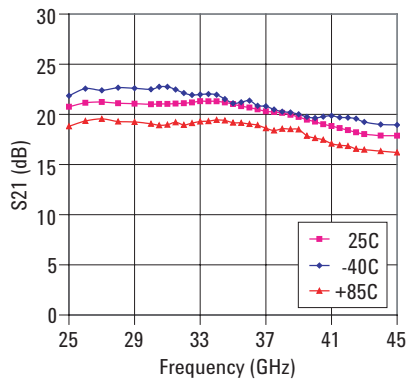

Figure 7. Gain Over Temperature

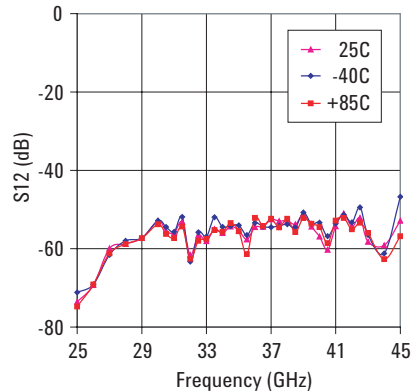

Figure 8. Isolation Over Temperature

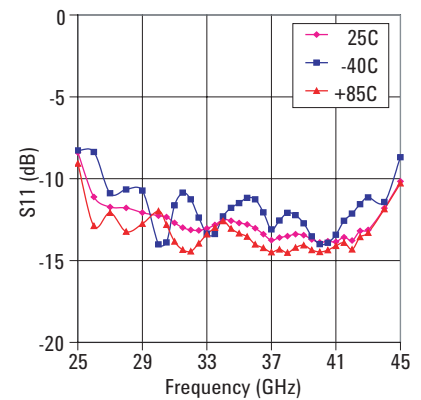

Figure 9. Input Return Loss Over Temperature

AMMC-6241 Typical Performances

($T_A = 25^\circ\text{C}$, $V_{d1} = V_{d2} = 3.0\text{ V}$, $I_{\text{total}} = 60\text{ mA}$, $Z_{\text{in}} = Z_{\text{out}} = 50\ \Omega$ unless otherwise stated)

NOTE: These measurements are in a 50 W test environment. Aspects of the amplifier performance may be improved over a narrower bandwidth by application of additional conjugate, linearity, or low noise (Gopt) matching.

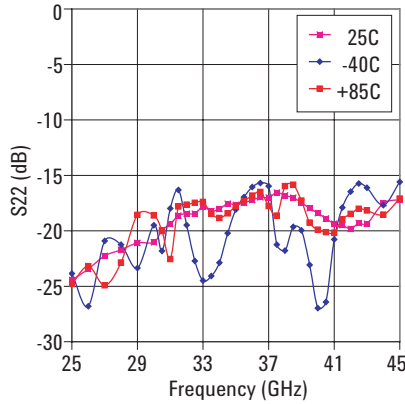

Figure 10. Output Return Loss Over Temperature

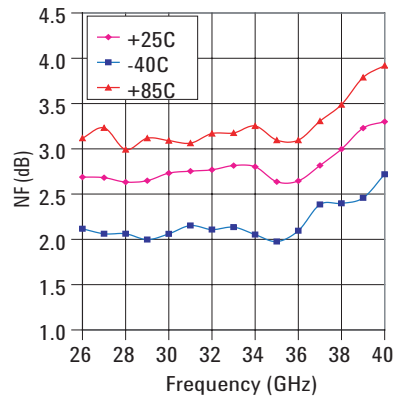

Figure 11. Noise Figure Over Temperature

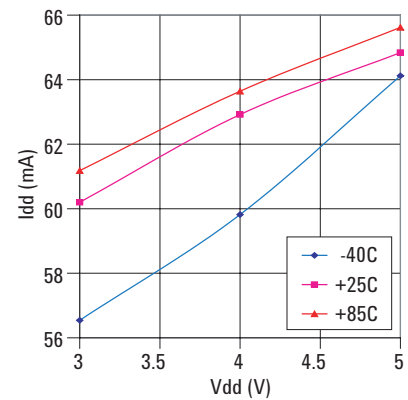

Figure 12. Typical Total Idd over Temperature

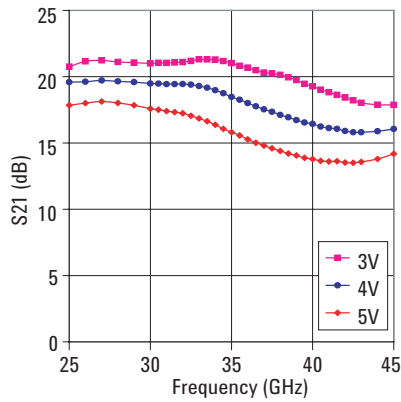

Figure 13. Gain over Vdd

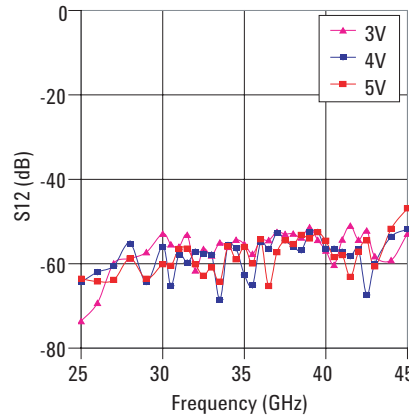

Figure 14. Isolation Over Vdd

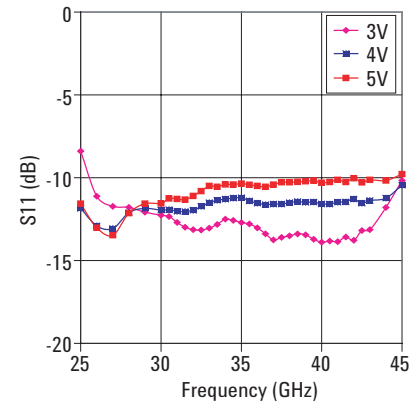

Figure 15. Input RL Over Vdd

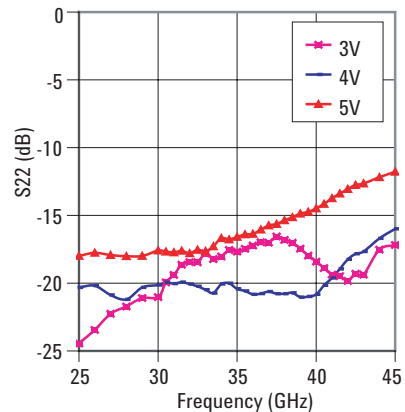

Figure 16. Output RL Over Vdd

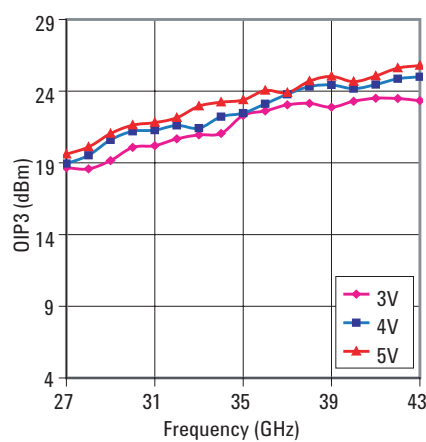

Figure 17. Output IP3 Over Vdd

AMMC-6241 Typical Scattering Parameters^[1]

(T_c=25°C, V_{D1}=V_{D2}= 3 V, I_{total}= 60 mA, Z_{in} = Z_{out} = 50 Ω) Note: Data obtained from on-wafer measurements

Freq GHz	S11			S21			S12			S22		
	dB	Mag	Phase	dB	Mag	Phase	dB	Mag	Phase	dB	Mag	Phase
15.0	-1.013	0.890	173.506	-7.637	0.415	-94.306	-59.891	0.001	132.755	-10.443	0.301	129.202
17.0	-1.306	0.860	152.019	5.022	1.783	163.635	-74.194	0.000	57.784	-14.828	0.181	102.094
19.0	-1.528	0.839	127.230	9.344	2.932	75.144	-58.181	0.001	46.460	-20.040	0.100	80.180
22.0	-2.642	0.738	74.942	15.740	6.123	-29.058	-71.353	0.000	-129.404	-27.825	0.041	4.390
24.0	-5.557	0.527	13.805	19.561	9.507	-103.326	-69.197	0.000	139.800	-28.011	0.040	-90.859
25.0	-8.397	0.380	-29.421	20.760	10.915	-143.267	-73.597	0.000	-65.707	-24.449	0.060	-110.024
26.0	-11.117	0.278	-81.009	21.155	11.422	178.829	-69.288	0.000	169.237	-23.448	0.067	-127.918
26.5	-11.627	0.262	-106.817	21.214	11.501	160.796	-58.793	0.001	-110.455	-22.500	0.075	-137.132
27.0	-11.731	0.259	-129.432	21.239	11.533	143.152	-59.928	0.001	-142.525	-22.260	0.077	-143.296
27.5	-11.805	0.257	-149.942	21.203	11.485	126.214	-58.475	0.001	-171.775	-21.694	0.082	-148.929
28.0	-11.787	0.257	-165.515	21.113	11.367	110.350	-58.768	0.001	-162.445	-21.715	0.082	-157.855
28.5	-12.038	0.250	-176.581	21.023	11.250	95.138	-57.465	0.001	158.458	-21.674	0.082	-156.390
29.0	-12.076	0.249	173.456	21.060	11.297	80.037	-57.267	0.001	169.607	-21.093	0.088	-165.820
29.5	-12.070	0.249	165.646	21.058	11.296	65.449	-55.391	0.002	168.814	-21.180	0.087	-168.128
30.0	-12.259	0.244	159.454	21.007	11.229	51.326	-52.903	0.002	134.843	-21.033	0.089	-165.016
30.5	-12.339	0.242	154.710	21.043	11.276	37.629	-55.427	0.002	92.750	-19.948	0.101	-169.860
31.0	-12.699	0.232	150.567	21.040	11.272	23.753	-55.992	0.002	109.517	-19.390	0.107	-174.803
31.5	-12.988	0.224	148.382	21.078	11.322	10.265	-53.178	0.002	109.357	-18.631	0.117	-177.679
32.0	-13.131	0.221	146.592	21.104	11.355	-3.075	-61.593	0.001	76.010	-18.449	0.120	173.486
32.5	-13.159	0.220	145.349	21.192	11.471	-16.397	-56.515	0.001	131.534	-18.461	0.119	168.589
33.0	-13.040	0.223	145.137	21.308	11.625	-30.578	-58.069	0.001	100.560	-17.807	0.129	164.643
33.5	-12.824	0.228	143.097	21.302	11.617	-44.533	-54.981	0.002	85.525	-18.223	0.123	157.797
34.0	-12.498	0.237	140.155	21.296	11.609	-58.173	-56.012	0.002	113.052	-18.033	0.125	155.542
34.5	-12.573	0.235	138.158	21.182	11.458	-72.363	-54.348	0.002	84.952	-17.550	0.133	150.830
35.0	-12.710	0.231	134.590	21.024	11.251	-85.797	-55.336	0.002	50.316	-17.667	0.131	145.841
35.5	-12.792	0.229	131.388	20.813	10.981	-98.385	-57.651	0.001	106.642	-17.466	0.134	143.100
36.0	-13.029	0.223	130.988	20.678	10.811	-111.390	-54.494	0.002	104.628	-17.225	0.138	137.833
36.5	-13.389	0.214	129.322	20.494	10.585	-123.674	-54.425	0.002	83.500	-16.978	0.142	131.310
37.0	-13.752	0.205	130.820	20.310	10.364	-136.026	-52.515	0.002	90.790	-17.004	0.141	127.335
37.5	-13.599	0.209	130.535	20.239	10.279	-147.683	-52.954	0.002	67.823	-16.551	0.149	120.618
38.0	-13.511	0.211	131.737	20.142	10.165	-160.235	-52.864	0.002	57.307	-16.813	0.144	113.724
38.5	-13.392	0.214	130.598	19.955	9.948	-172.253	-53.785	0.002	81.931	-17.019	0.141	107.173
39.0	-13.449	0.213	130.777	19.742	9.708	175.463	-51.373	0.003	54.256	-17.453	0.134	100.864
39.5	-13.713	0.206	130.341	19.463	9.400	164.088	-54.373	0.002	53.324	-17.967	0.126	97.791
40.0	-13.892	0.202	130.693	19.274	9.198	152.397	-56.900	0.001	27.630	-18.409	0.120	94.365
40.5	-13.822	0.204	131.722	19.016	8.929	141.026	-60.282	0.001	22.819	-18.887	0.114	92.964
41.0	-13.857	0.203	133.603	18.830	8.740	129.648	-54.278	0.002	32.324	-19.364	0.108	92.290
41.5	-13.578	0.209	134.336	18.631	8.542	118.871	-51.010	0.003	-8.926	-19.483	0.106	92.508
42.0	-13.775	0.205	136.724	18.429	8.346	107.881	-54.346	0.002	41.468	-19.835	0.102	94.045
42.5	-13.188	0.219	139.343	18.218	8.145	97.768	-52.144	0.002	19.887	-19.299	0.108	94.187
43.0	-13.131	0.221	142.382	18.030	7.970	87.333	-58.236	0.001	-38.809	-19.365	0.108	93.694
44.0	-11.798	0.257	146.033	17.887	7.841	67.235	-59.155	0.001	-43.306	-17.525	0.133	90.759
45.0	-10.167	0.310	147.240	17.877	7.831	45.991	-52.882	0.002	162.395	-17.185	0.138	81.030
46.0	-8.784	0.364	144.663	17.791	7.755	24.481	-52.831	0.002	-14.230	-17.248	0.137	74.975
47.0	-7.425	0.425	139.414	17.680	7.656	2.691	-50.765	0.003	-17.966	-16.593	0.148	69.936
48.0	-6.079	0.497	135.513	17.700	7.673	-19.090	-53.926	0.002	-12.616	-15.788	0.162	60.992
49.0	-4.403	0.602	128.030	17.793	7.756	-43.456	-52.746	0.002	110.943	-15.204	0.174	57.597
50.0	-2.878	0.718	120.056	17.615	7.599	-66.790	-49.370	0.003	18.237	-14.953	0.179	47.450

AMMC-6241 Typical Scattering Parameters^[1]

(T_c=25°C, V_{D1}=V_{D2}= 5 V, I_{total}= 65 mA, Z_{in} = Z_{out} = 50 Ω) Note: Data obtained from on-wafer measurements

Freq GHz	S11			S21			S12			S22		
	dB	Mag	Phase	dB	Mag	Phase	dB	Mag	Phase	dB	Mag	Phase
15.0	-0.954	0.896	175.370	-8.236	0.387	-97.484	-58.789	0.001	74.582	-9.268	0.344	119.399
17.0	-1.228	0.868	153.538	4.910	1.760	149.468	-58.503	0.001	111.433	-12.649	0.233	86.348
19.0	-1.693	0.823	127.796	9.038	2.831	54.112	-64.600	0.001	82.329	-15.405	0.170	56.944
22.0	-4.463	0.598	72.488	14.671	5.415	-60.910	-64.010	0.001	104.610	-17.425	0.135	4.474
24.0	-10.804	0.288	7.846	17.336	7.359	-139.132	-64.039	0.001	-127.800	-17.988	0.126	-25.688
25.0	-15.616	0.166	-49.454	17.926	7.876	-177.892	-63.440	0.001	-139.623	-18.079	0.125	-40.543
26.0	-15.749	0.163	-118.695	18.185	8.114	145.637	-66.326	0.000	135.455	-18.089	0.125	-51.511
26.5	-14.388	0.191	-142.095	18.195	8.123	127.785	-60.997	0.001	147.814	-18.056	0.125	-56.680
27.0	-13.469	0.212	-157.405	18.134	8.067	111.019	-63.857	0.001	107.728	-17.926	0.127	-61.943
27.5	-12.672	0.232	-168.987	18.081	8.018	94.474	-62.998	0.001	160.703	-18.032	0.125	-67.733
28.0	-12.138	0.247	-179.012	18.015	7.957	78.323	-58.768	0.001	154.081	-18.015	0.126	-70.838
28.5	-11.933	0.253	175.281	17.898	7.850	63.047	-60.915	0.001	142.052	-17.578	0.132	-75.742
29.0	-11.570	0.264	168.288	17.844	7.802	47.754	-63.581	0.001	137.503	-17.990	0.126	-81.550
29.5	-11.350	0.271	163.120	17.735	7.704	32.835	-62.100	0.001	146.597	-18.079	0.125	-83.191
30.0	-11.555	0.264	160.007	17.591	7.578	18.567	-60.126	0.001	95.390	-17.595	0.132	-87.204
30.5	-11.254	0.274	157.772	17.515	7.512	4.174	-60.519	0.001	109.746	-17.674	0.131	-91.933
31.0	-11.283	0.273	155.500	17.405	7.417	-9.721	-56.518	0.001	129.344	-17.733	0.130	-94.827
31.5	-11.322	0.272	152.983	17.327	7.351	-23.446	-56.438	0.002	93.162	-17.607	0.132	-97.411
32.0	-11.104	0.278	151.391	17.244	7.281	-37.449	-60.113	0.001	102.403	-17.794	0.129	-99.657
32.5	-10.807	0.288	149.758	17.048	7.118	-51.248	-62.866	0.001	109.088	-17.546	0.133	-101.921
33.0	-10.496	0.299	147.850	16.850	6.959	-64.998	-60.915	0.001	105.331	-17.643	0.131	-104.875
33.5	-10.547	0.297	145.153	16.638	6.790	-78.200	-64.266	0.001	126.300	-17.286	0.137	-105.042
34.0	-10.404	0.302	143.126	16.371	6.585	-91.518	-55.886	0.002	113.278	-16.680	0.147	-110.187
34.5	-10.415	0.301	140.889	16.064	6.356	-103.678	-58.954	0.001	93.294	-16.775	0.145	-113.869
35.0	-10.362	0.303	138.559	15.807	6.171	-115.864	-56.036	0.002	103.385	-16.586	0.148	-114.914
35.5	-10.429	0.301	136.295	15.574	6.008	-127.653	-59.955	0.001	155.593	-16.405	0.151	-117.350
36.0	-10.496	0.299	134.946	15.279	5.807	-138.958	-54.224	0.002	99.686	-16.368	0.152	-119.576
36.5	-10.552	0.297	133.658	15.017	5.635	-150.079	-65.294	0.001	97.414	-16.046	0.158	-122.641
37.0	-10.420	0.301	132.618	14.810	5.502	-161.113	-57.283	0.001	119.408	-15.743	0.163	-125.742
37.5	-10.278	0.306	132.713	14.595	5.367	-171.710	-54.466	0.002	88.985	-15.643	0.165	-129.586
38.0	-10.279	0.306	130.938	14.400	5.248	177.346	-55.347	0.002	118.334	-15.366	0.170	-131.580
38.5	-10.249	0.307	128.628	14.210	5.134	167.047	-53.201	0.002	103.431	-15.139	0.175	-134.722
39.0	-10.210	0.309	128.373	14.060	5.047	156.768	-54.049	0.002	75.833	-14.871	0.180	-136.323
39.5	-10.178	0.310	126.565	13.885	4.946	147.006	-52.533	0.002	92.297	-14.738	0.183	-139.034
40.0	-10.306	0.305	125.591	13.784	4.889	137.311	-54.574	0.002	69.756	-14.487	0.189	-141.707
40.5	-10.258	0.307	125.375	13.652	4.815	127.521	-58.441	0.001	108.679	-14.153	0.196	-145.685
41.0	-10.127	0.312	124.344	13.606	4.790	117.909	-57.963	0.001	67.753	-13.736	0.206	-149.614
41.5	-10.264	0.307	124.574	13.621	4.798	107.923	-63.136	0.001	22.773	-13.394	0.214	-152.750
42.0	-10.032	0.315	123.150	13.524	4.745	98.584	-57.167	0.001	59.413	-13.059	0.222	-157.118
42.5	-10.283	0.306	124.307	13.509	4.736	89.573	-54.474	0.002	112.809	-12.764	0.230	-161.086
43.0	-10.126	0.312	121.899	13.579	4.775	80.311	-60.628	0.001	127.139	-12.652	0.233	-164.450
44.0	-10.167	0.310	124.109	13.792	4.893	61.548	-51.744	0.003	153.671	-12.185	0.246	-174.591
45.0	-9.783	0.324	125.766	14.185	5.120	42.684	-46.879	0.005	122.651	-11.784	0.258	177.006
46.0	-9.264	0.344	127.464	14.828	5.513	23.764	-49.932	0.003	96.883	-11.499	0.266	170.747
47.0	-8.307	0.384	129.119	15.605	6.029	3.192	-46.375	0.005	107.536	-10.948	0.284	163.908
48.0	-7.300	0.432	129.338	16.576	6.742	-18.746	-47.935	0.004	100.387	-10.276	0.306	155.748
49.0	-5.323	0.542	131.169	17.761	7.727	-44.350	-44.298	0.006	78.726	-9.333	0.341	147.162
50.0	-2.732	0.730	130.750	18.988	8.900	-72.015	-41.210	0.009	80.639	-8.077	0.395	136.626

Biasing and Operation

The AMMC-6241 is normally biased with a positive supply connected to both V_{D1} and V_{D2} bond pads through the 100pF bypass capacitor as shown in Figure 21. The recommended supply voltage is 3 V. It is important to place the bypass capacitor as close to the die as possible. No negative gate bias voltage is needed for the AMMC-6241. Input and output matching are achieved on-die, therefore no other external component is required besides one 100pF bypass capacitor for the main supply. The input and output are DC-blocked with internal coupling capacitors.

No ground wires are needed because all ground connections are made with plated through-holes to the backside of the device.

Refer the Absolute Maximum Ratings table for allowed DC and thermal conditions.

Assembly Techniques

The backside of the MMIC chip is RF ground. For microstrip applications the chip should be attached directly to the ground plane (e.g. circuit carrier or heatsink) using electrically conductive epoxy [1,2].

For best performance, the topside of the MMIC should be brought up to the same height as the circuit surrounding it. This can be accomplished by mounting a gold plate metal shim (same length and width as the MMIC) under the chip which is of correct thickness to make the chip and adjacent circuit the same height. The amount of epoxy used for the chip and/or shim attachment should

be just enough to provide a thin fillet around the bottom perimeter of the chip or shim. The ground plan should be free of any residue that may jeopardize electrical or mechanical attachment.

The location of the RF bond pads is shown in Figure 12. Note that all the RF input and output ports are in a Ground-Signal-Ground configuration.

RF connections should be kept as short as reasonable to minimize performance degradation due to undesirable series inductance. A single bond wire is normally sufficient for signal connections, however double bonding with 0.7 mil gold wire or use of gold mesh is recommended for best performance, especially near the high end of the frequency band.

Thermosonic wedge bonding is preferred method for wire attachment to the bond pads. Gold mesh can be attached using a 2 mil round tracking tool and a tool force of approximately 22 grams and a ultrasonic power of roughly 55 dB for a duration of 76 +/- 8 mS. The guided wedge at an ultrasonic power level of 64 dB can be used for 0.7 mil wire. The recommended wire bond stage temperature is 150 +/- 2C.

Caution should be taken to not exceed the Absolute Maximum

Notes:

1. Ablebond 84-1 LM1 silver epoxy is recommended.
2. Eutectic attach is not recommended and may jeopardize reliability of the device.

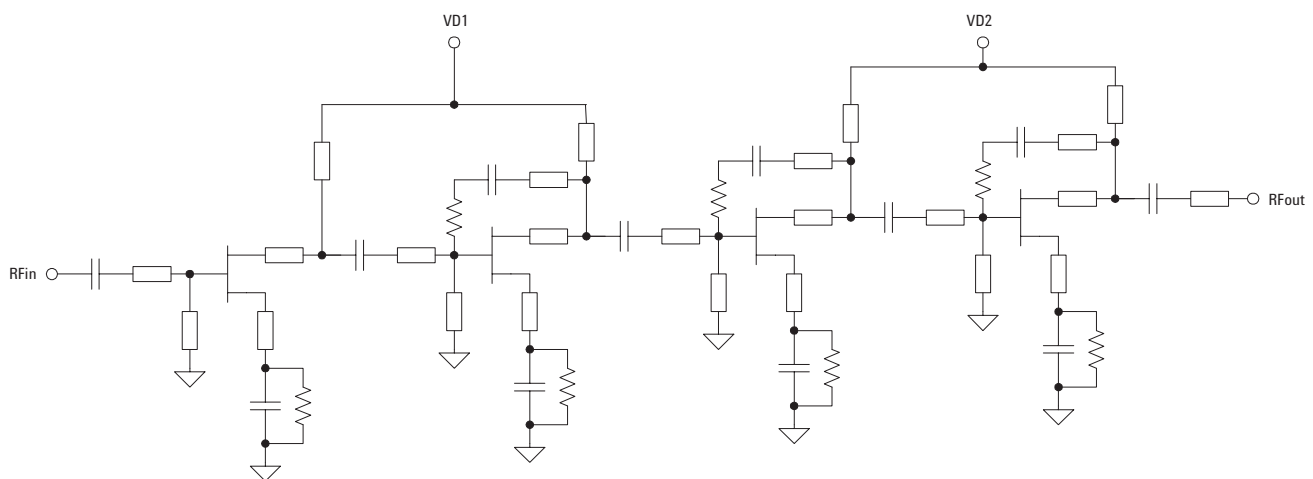

Figure 18. AMMC-6241 Simplified Schematic

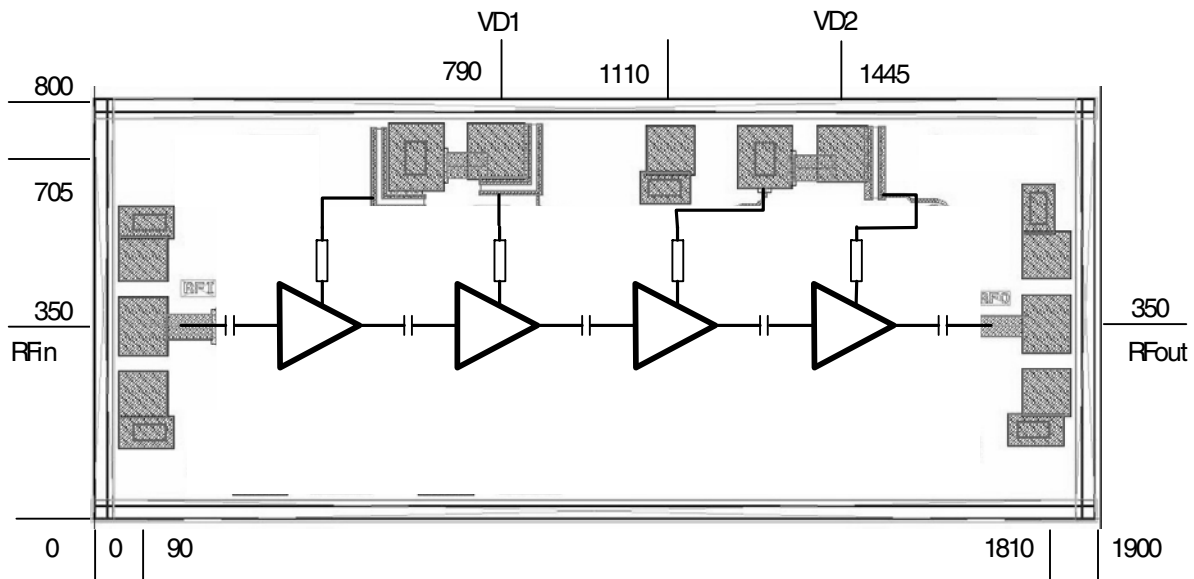

Figure 19. AMMC-6241 Bonding pad locations

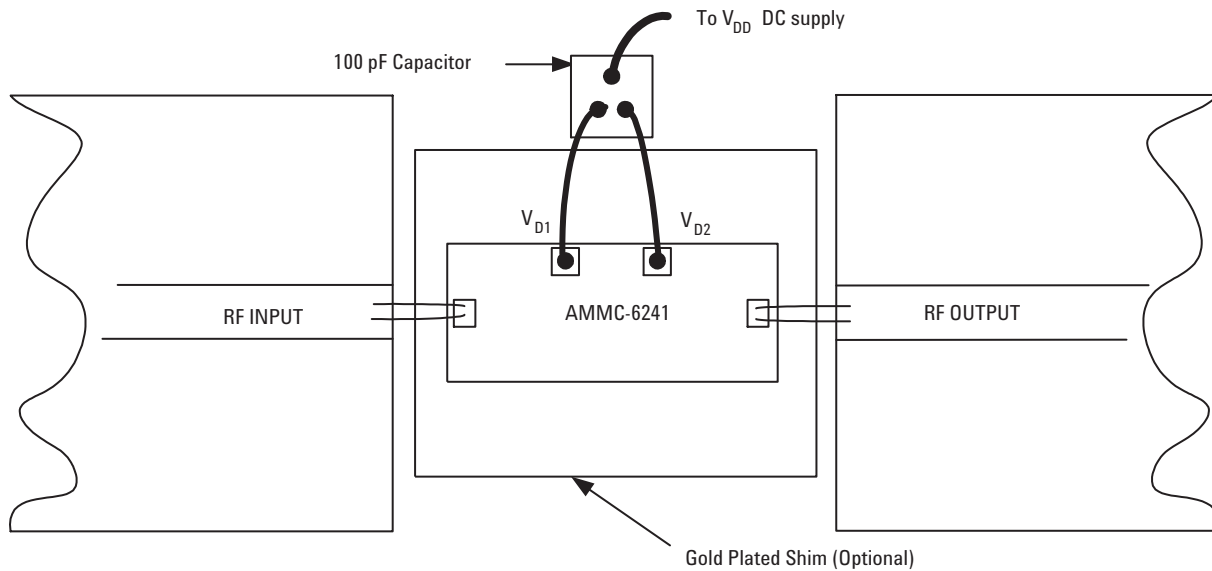

Figure 20. AMMC-6241 Assembly diagram

Ordering Information:

AMMC-6241-W10 = 10 devices per tray

AMMC-6241-W50 = 50 devices per tray

For product information and a complete list of distributors, please go to our web site: www.avagotech.com

Avago, Avago Technologies, and the A logo are trademarks of Avago Technologies Limited in the United States and other countries. Data subject to change. Copyright © 2005-2008 Avago Technologies Limited. All rights reserved. Obsoletes AV01-0231EN AV02-13xxEN - June 23, 2008

