

Product Dimensions

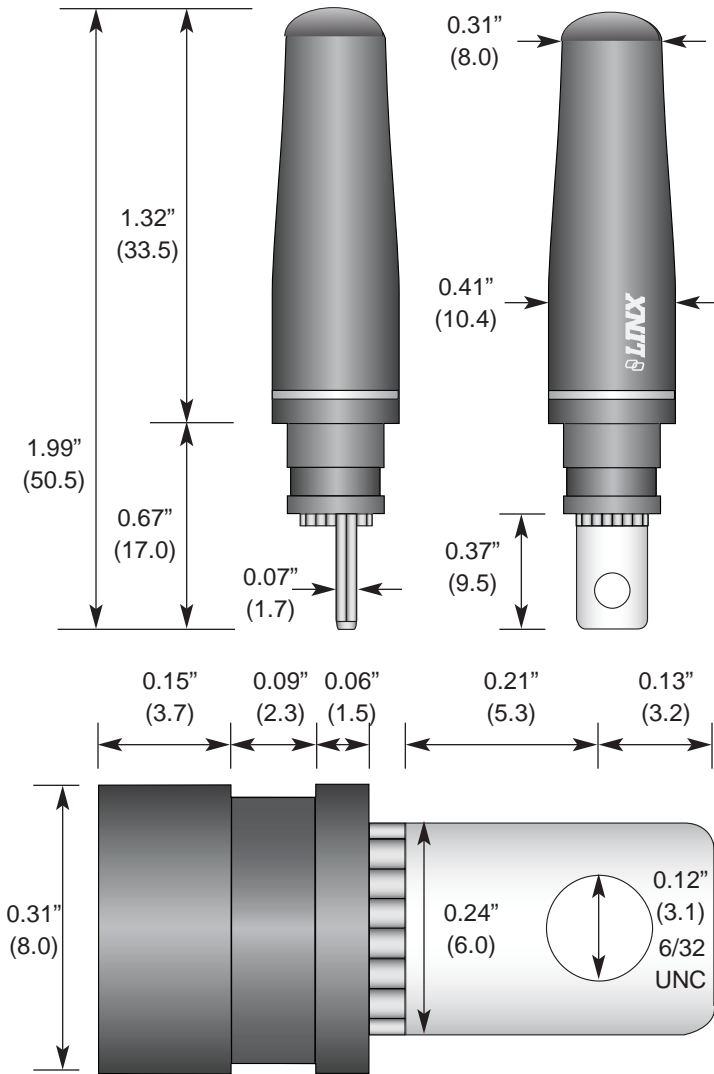

Recommended Footprint

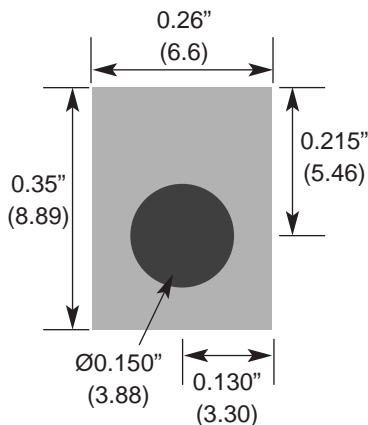

Description



LP Series antennas utilize a helical element, which greatly reduces the antenna's size while allowing favorable performance characteristics. These compact antennas are cosmetically attractive and inexpensive, making them ideal for volume applications. The LP Series mounts directly with a single screw, eliminating the expense of a connector while meeting FCC Part 15 requirements.

Features

- Very low cost
 - Compact housing
 - Excellent performance
 - Omni-directional pattern
 - Weather-resistant
 - Screw-mount
 - Use with plastic* or metal enclosures
- * Requires proximity ground plane

Electrical Specifications

- Center Freq. 868MHz
- Bandwidth 72MHz
- Wavelength 1/4-wave
- VSWR <1.9 typ. at center
- Impedance 50 ohms
- Connection Screw-mount

Electrical specifications and plots measured on 1.5" x 3.3" reference ground plane

Ordering Information

- ANT-868-PW-LP

VSWR Graph

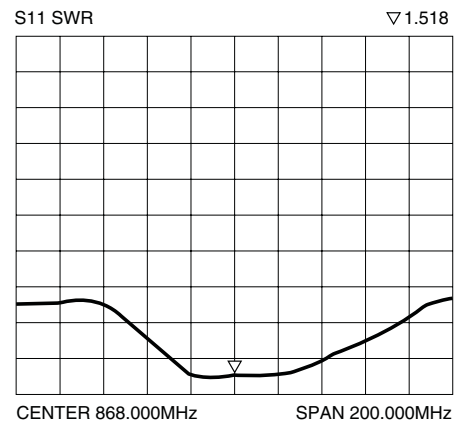

Typical VSWR