



Specification

SPECIFICATION

- Part No. : **TG.22.0111**
- Product Name : Penta-Band Cellular Connector Mount Dipole
GSM-DCS-PCS-UMTS-CDMA-GPRS-EDGE-HSPA
800MHz ~2200 MHz
- Features : 0dBi Gain
Straight SMA Male, 50 Ohms
ROHS Compliant



REVISION STATUS

Version	Date	Page	Revision Description	Prepared	Approved
01	April 06 2009	All	New product	TW Product Centre	Ronan Quinlan

© All Rights Reserved

Taoglas Limited, Unit 7 Peare Campus, Moyne Business Park, Enniscorthy, Co. Wexford, Ireland
info@taoglas.com +353 53 9169500 www.taoglas.com



Specification

1.0 Introduction

The TG.22.0111, Penta-band GSM-DCS-PCS-UMTS-CDMA-GPRS-EDGE-HSPA 800MHz to 2200MHz dipole antenna is a quality robust antenna with high gain in small form factor. Connection is made via straight SMA(M) connector. With a hardened waterproof PU casing, this antenna is the ideal GSM antenna for telematics devices.

2.0 Key Antenna Performance Indicators

Electrical Specifications

Parameter	Specification
Frequency range	800MHz to 2200MHz
Bands	GSM-DCS-PCS-UMTS-CDMA-GPRS-EDGE-HSPA
VSWR	≤ 2.3
Polarization	Linear
Power handling	20 W
Impedance	50 Ohms
Connector	Straight SMA(M)

Environmental & Mechanical Characteristics

Parameter	Specification
Temperature	-40°C to +85°C
Radome color	Black
Radome material	Pu
Weight	6 g



3.0 Return Loss (dB)

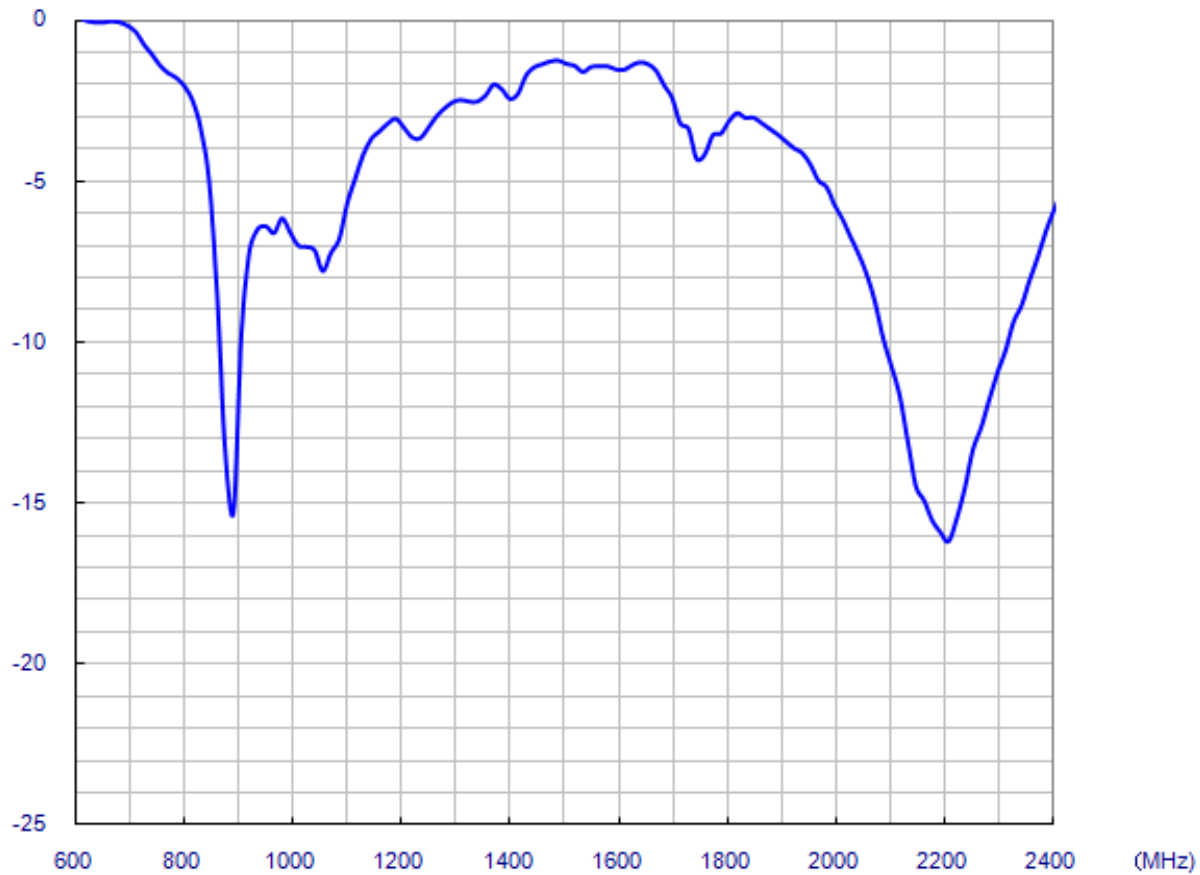

Specification

3.1 Efficiency (dB)

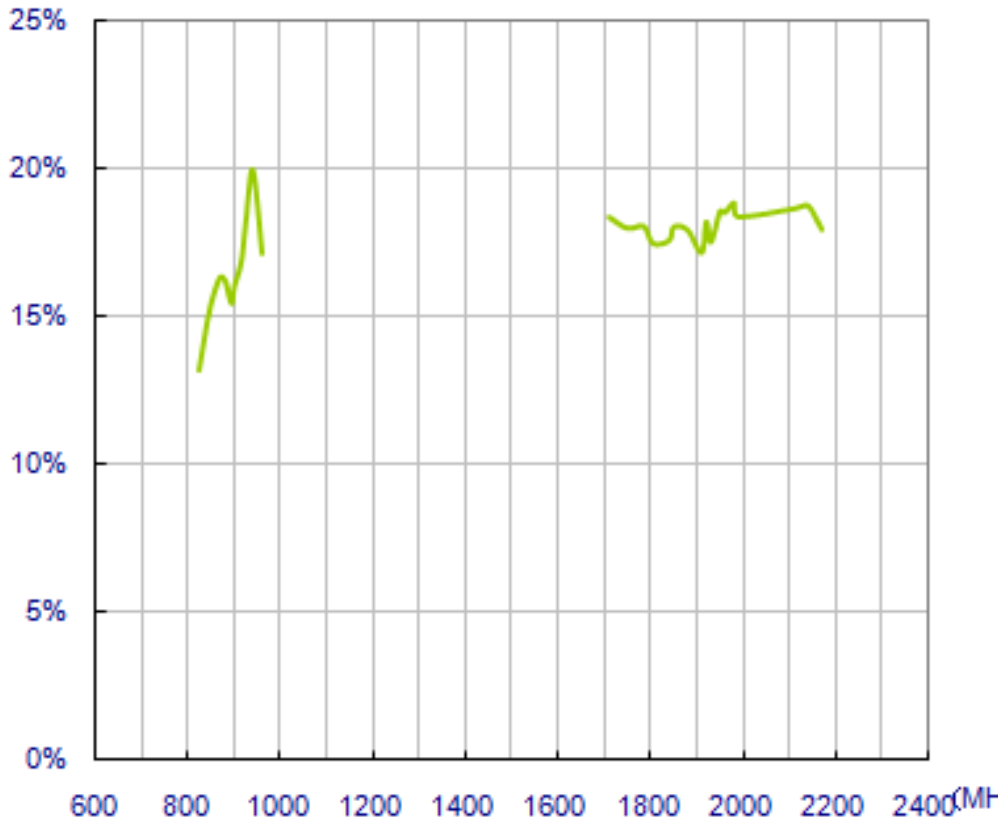

TG-22-0111	
Frequency	Efficiency
824	13.18%
836	14.31%
849	15.37%
869	16.30%
880	16.21%
894	15.43%
900	16.01%
915	16.83%
925	18.20%
940	19.92%
960	17.11%
1575	14.98%
1710	18.33%
1750	17.96%
1785	18.03%
1805	17.45%
1840	17.55%
1850	18.01%
1880	17.90%
1910	17.13%
1920	18.18%
1930	17.50%
1950	18.53%
1960	18.48%
1980	18.81%
1990	18.35%
2110	18.62%
2140	18.72%
2170	17.92%



3.3 Radiation Pattern Data

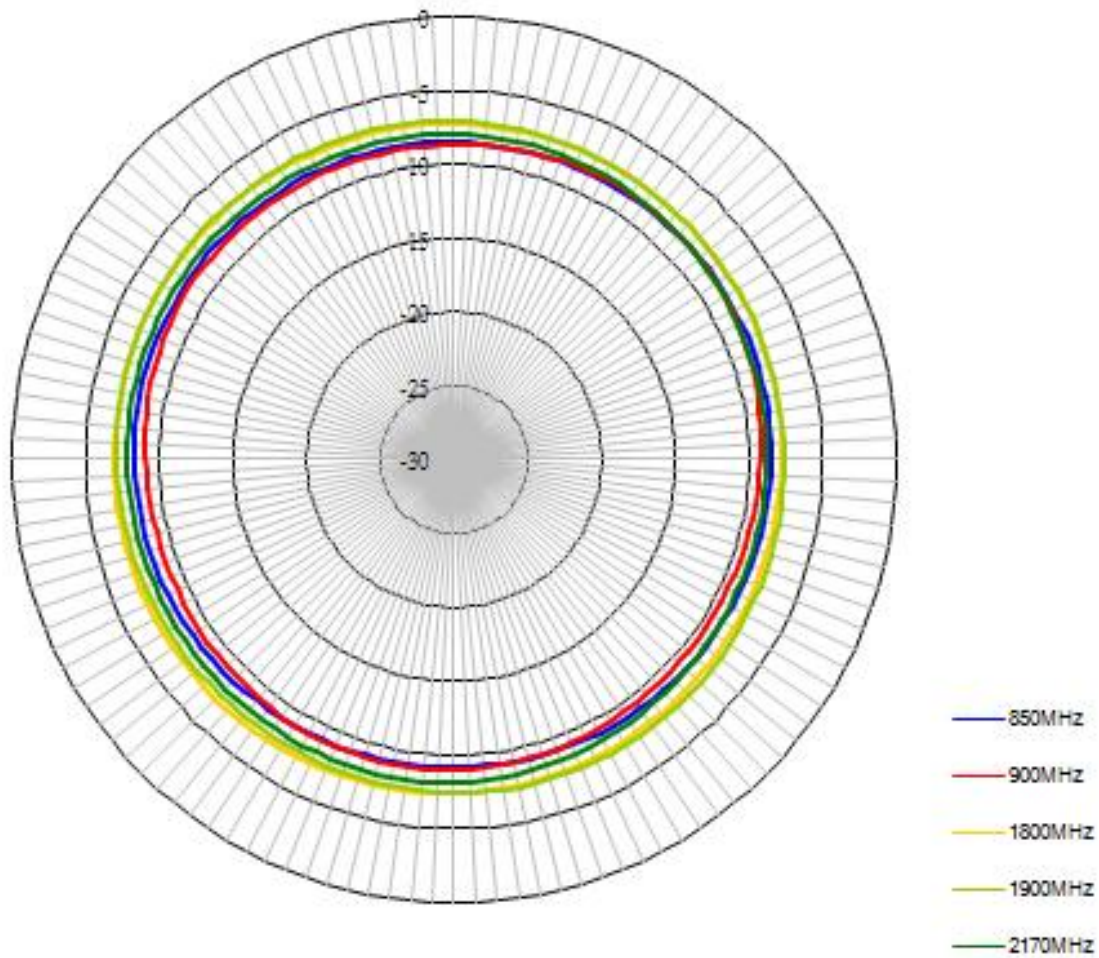

A. Radiation Pattern, Azimuth Plane (XY)



Specification

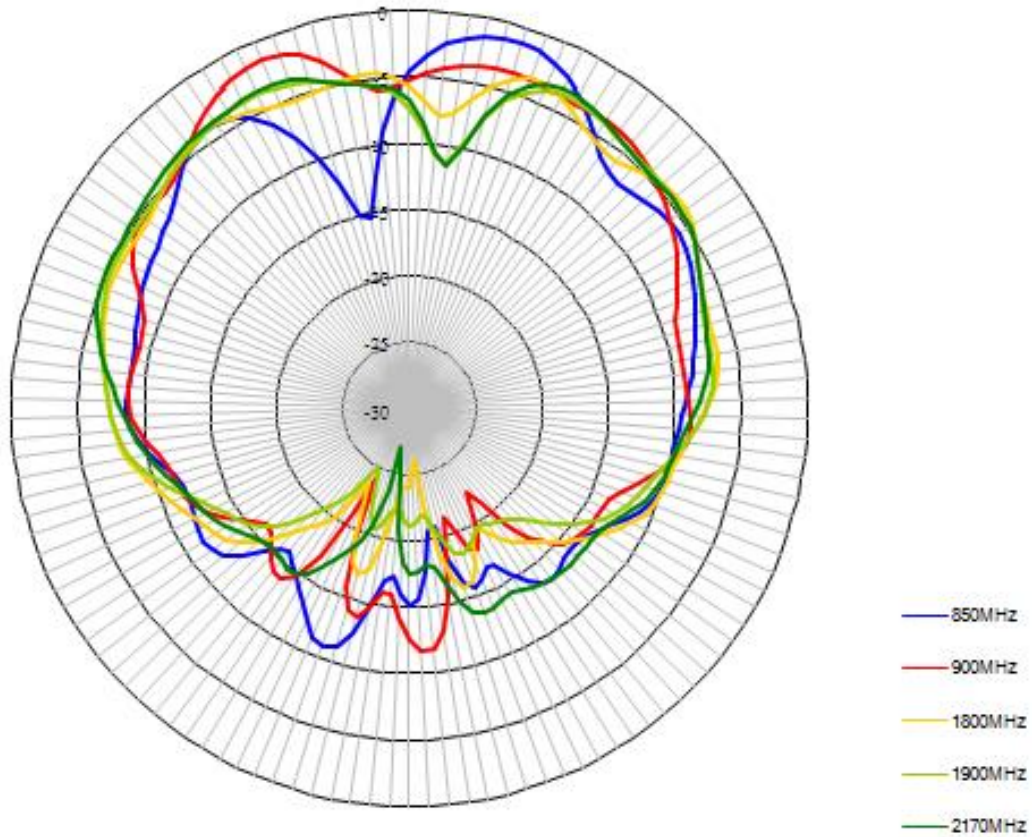

B. Radiation Pattern, Aligned at the Connector



Specification

GPS

-3.05gain

15% radiation efficienc

Radiation Pattern, Aligned at the Connector

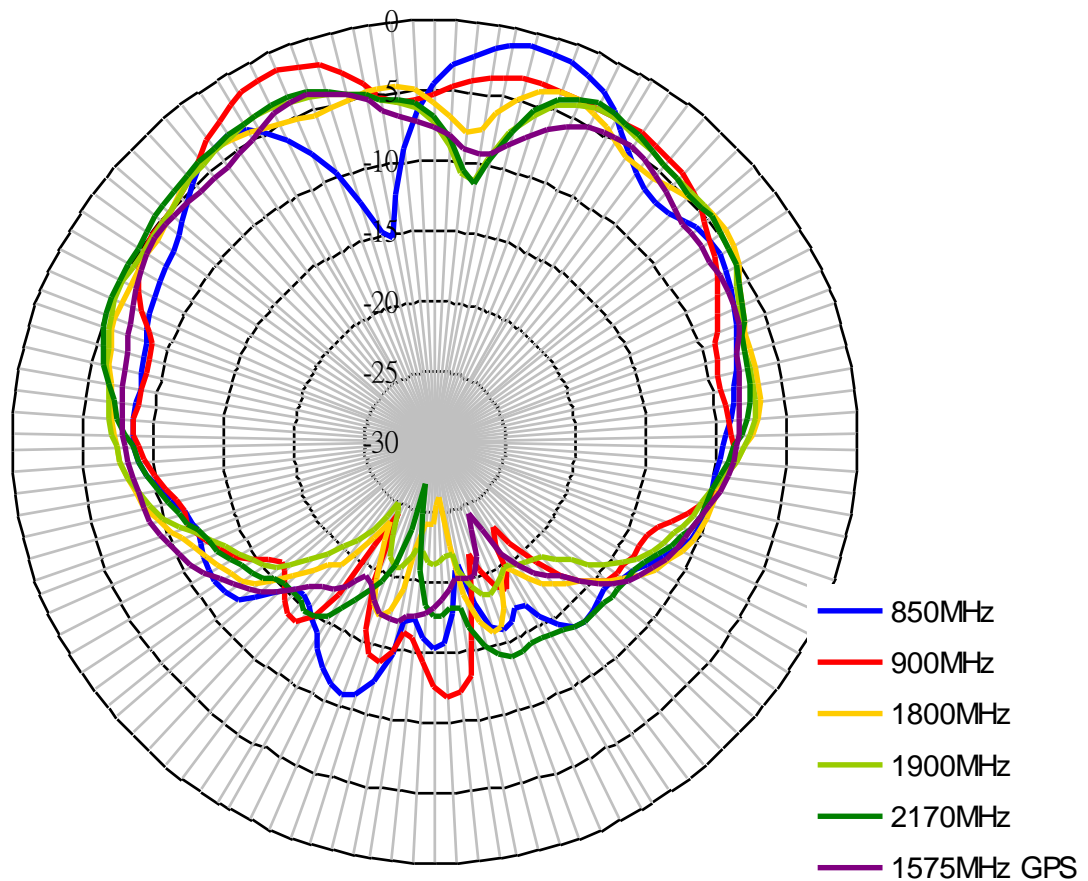

© All Rights Reserved

Taoglas Limited, Unit 7 Peare Campus, Moyne Business Park, Enniscorthy, Co. Wexford, Ireland
info@taoglas.com

+353 53 9169500

www.taoglas.com



Specification

Radiation Pattern, Azimuth Plane (XY)

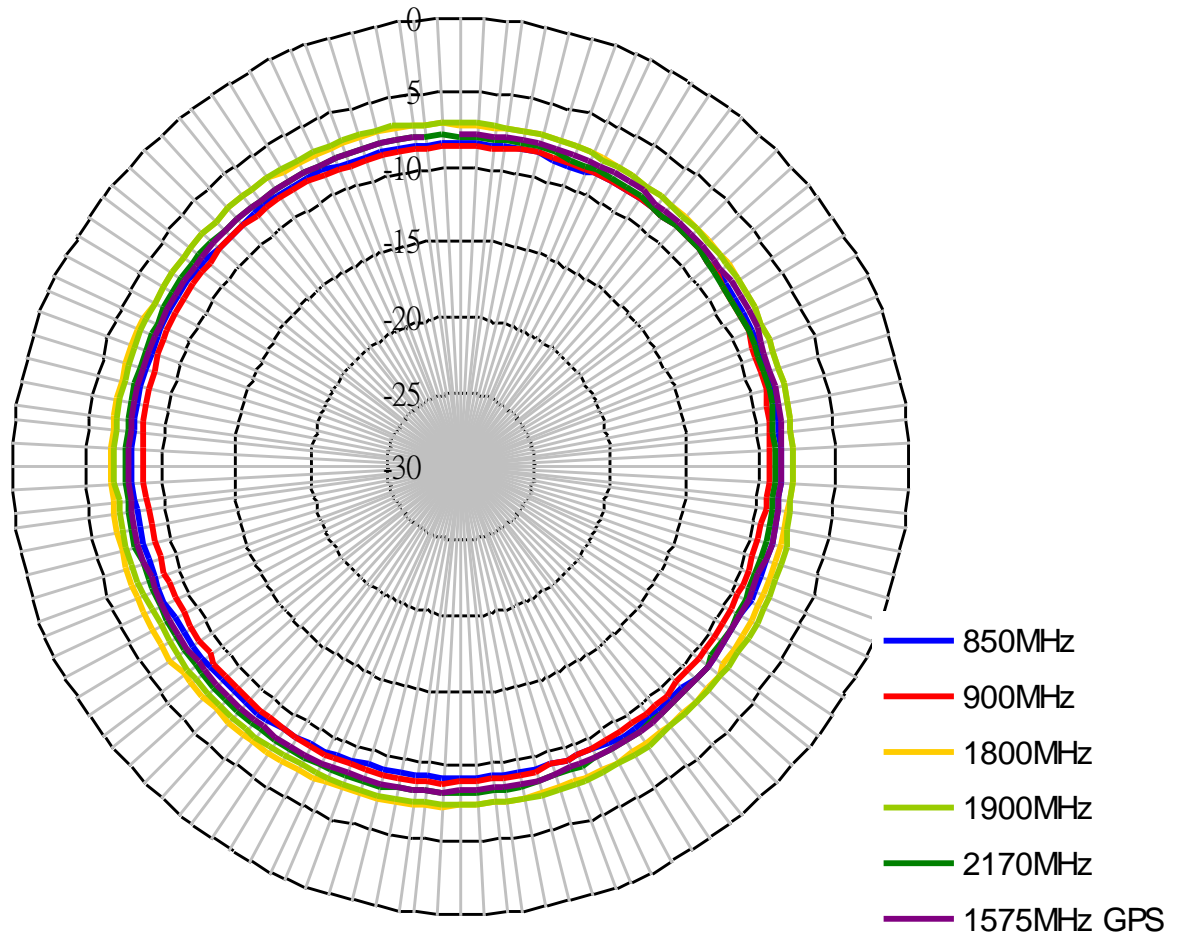



Specification

Radiation pattern – 1575MHz only

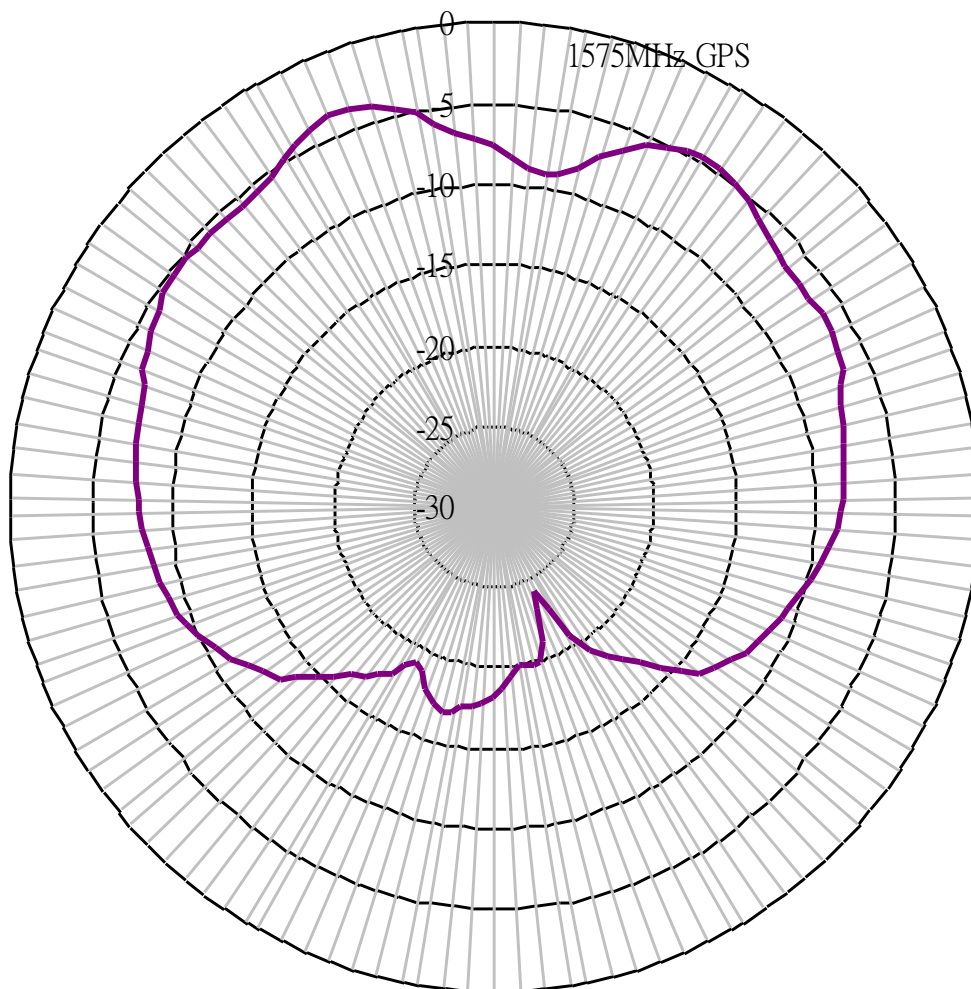

© All Rights Reserved

Taoglas Limited, Unit 7 Peare Campus, Moyne Business Park, Enniscorthy, Co. Wexford, Ireland
info@taoglas.com

+353 53 9169500

www.taoglas.com



Specification

Radiation Pattern, Azimuth Plane (XY) – 1575MHz only

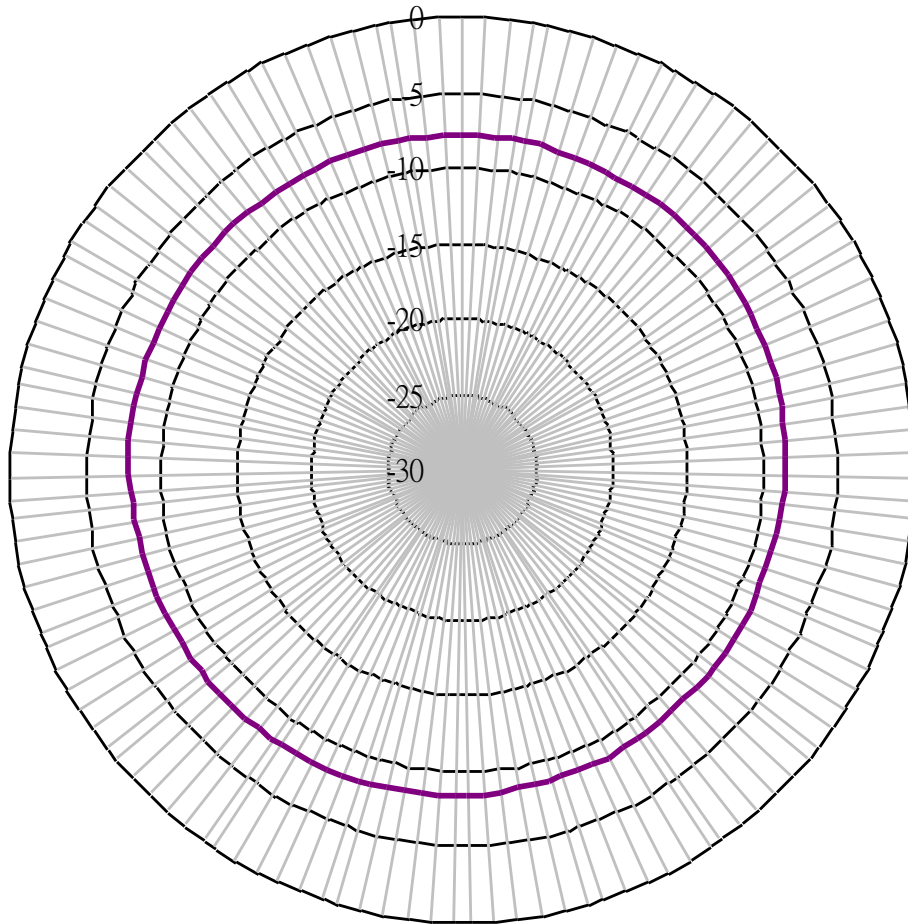

© All Rights Reserved

Taoglas Limited, Unit 7 Peare Campus, Moyne Business Park, Enniscorthy, Co. Wexford, Ireland
info@taoglas.com

+353 53 9169500

www.taoglas.com



4.0 Drawing and Dimensions

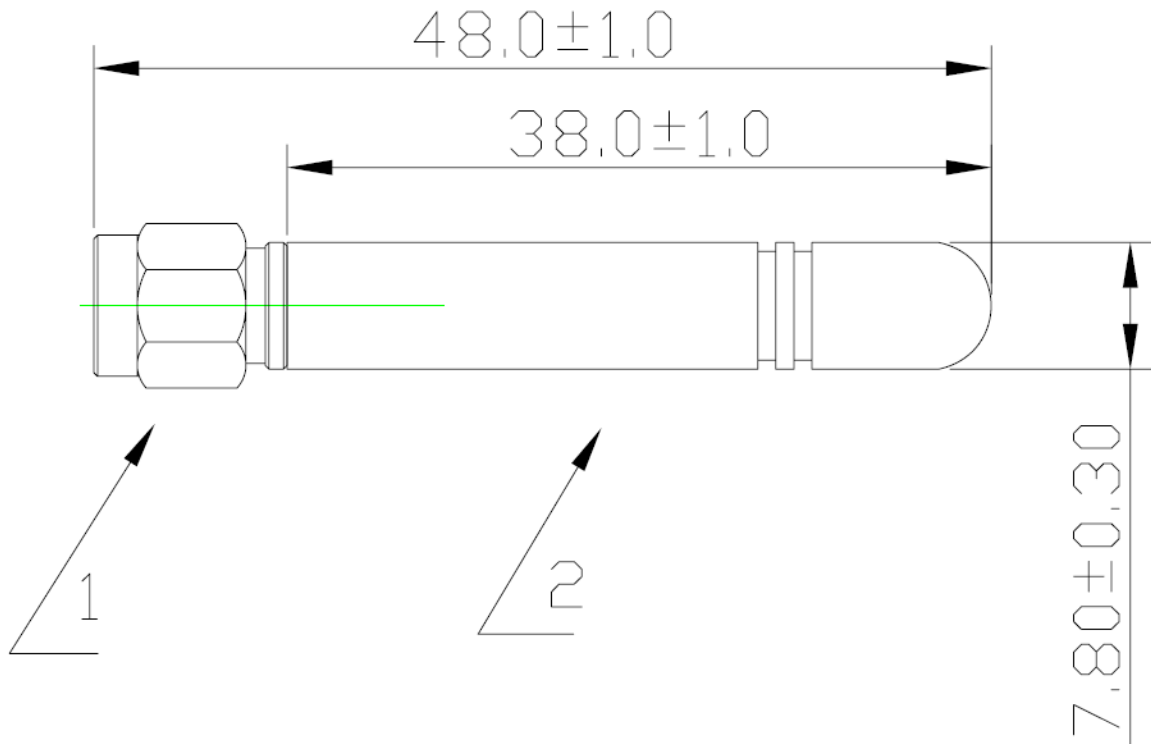

Note:
Unit:mm
SMA(M) Connector