

Product Dimensions

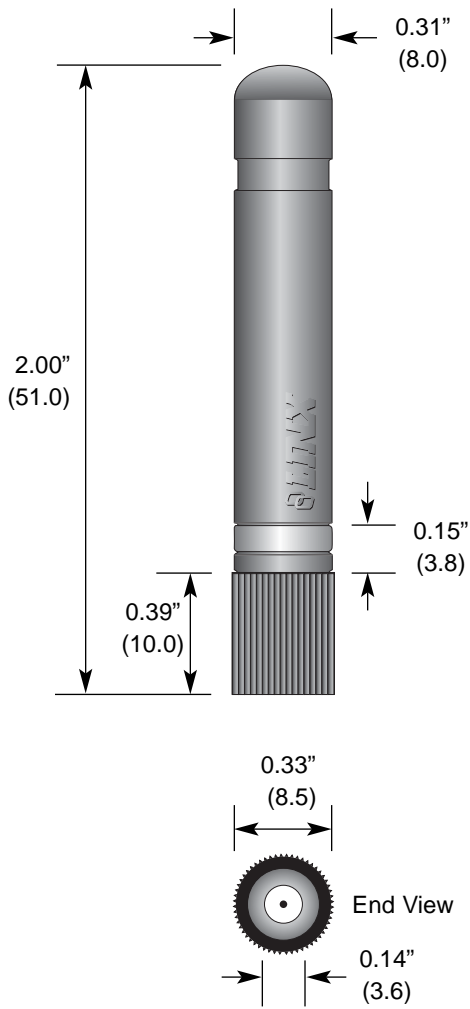

Description



The RH Series utilizes a helical element to greatly reduce the physical length of the antenna housing. They are ideal for small products where cosmetic or functional requirements dictate a compact, aesthetically pleasing antenna package. Despite their tiny size, RH Series antennas are ruggedly constructed and able to withstand punishing environments just like our larger whips. RH Series antennas attach via an SMA or Part 15 compliant RP-SMA connector.

Features

- Reduced-height helical whip
 - Excellent performance
 - Omni-directional pattern
 - Low VSWR
 - Fully weatherized
 - Rugged & damage-resistant
 - SMA or Part 15 compliant RP-SMA connector
 - Available in black or custom colors
 - Use with plastic* or metal enclosures
- * Requires proximity ground plane

Electrical Specifications

- Center Freq. 418MHz
- Bandwidth 10MHz
- Wavelength 1/4-wave
- VSWR <1.9 typ. at center
- Impedance 50 ohms
- Connector RP-SMA or SMA

Electrical specifications and plots measured on 4.00" x 4.00" reference ground plane

Ordering Information

- ANT-418-CW-RH (with RP-SMA connector)
- ANT-418-CW-RH-SMA (with SMA connector)

VSWR Graph

