



# Specification

Part No. : **ILA.01**

Model : 1dBi 915MHz High Efficiency Loop Antenna

Description : 902MHz to 928MHz

Features : 10\*3.2\*0.6mm  
50 Ohm Impedance

**RoHS** ✓



ILA.01 Antenna

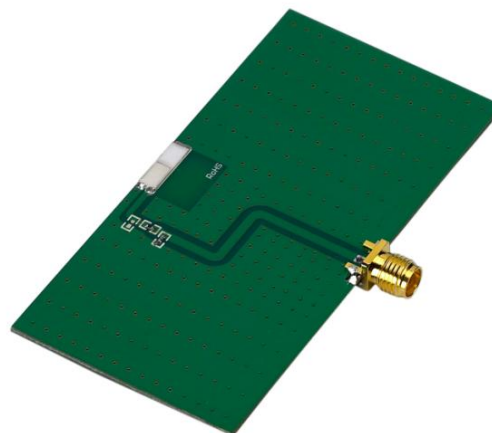

ILAD.01 (ILA.01 on EVB)

## REVISION STATUS

Version	Date	Page	Revision Description	Prepared	Approved
01	30 Sep 2009	All	Updated	TW PDC	Ronan Quinlan



## Specification

### 1. Introduction

The ILA.01 has excellent stability and sensitivity to consistently provide high signal reception efficiency, 70% at centre frequency.

Based on the loop effect this antenna works best when placed on the centre of the edge of the board, but can still work better than traditional linear polarized chip antennas even when placed at corners as substitute.

The antenna at 10\*3.2\*0.6mm is low profile and would be suitable for devices with space constraints. The ILA.01 is delivered on tape and reel and now allows M2M customers to use an omni-directional antenna in devices where orientation of the product is unknown.

#### 1.1 Applications

\*Automated Meter Reading (AMR)

\*Remote Monitoring

\*Healthcare

\*Communications

\*RFID

### 2.0 Key Performance Indicators

The antenna performance was measured with the ILA.01 mounted on the evaluation board (80\*40mm) with SMA(F) connector.

No	Parameter	Specification
1	Center Frequency	915MHz
2	Dimensions	10*3.2*0.6mm
3	Polarization	Linear
4	Bandwidth	Min. 26MHz(under -10dB return Loss)
5	Peak Gain	0.9dBi typ.
6	Efficiency	70% typ.
7	Impedance	50 Ω
8	Operating Temperature	-40°C~+85°C
9	Temperature Coefficient ( $\tau_f$ )	0 ± 20 ppm @ -20°C to +80°C

\* Center frequency will be offset to working frequency according to the conditions of user's Ground plane and radome.

\*\*The data was measured by A Test Lab Techno Corp. (CTIA Authorized Test Lab).

© All Rights Reserved

Taoglas Limited, Unit 7 Peare Campus, Moyne Business Park, Enniscorthy, Co. Wexford, Ireland

info@taoglas.com

+353 53 9169500

www.taoglas.com



Specification

3.0 Antenna Dimensions & Test Board (unit:mm)

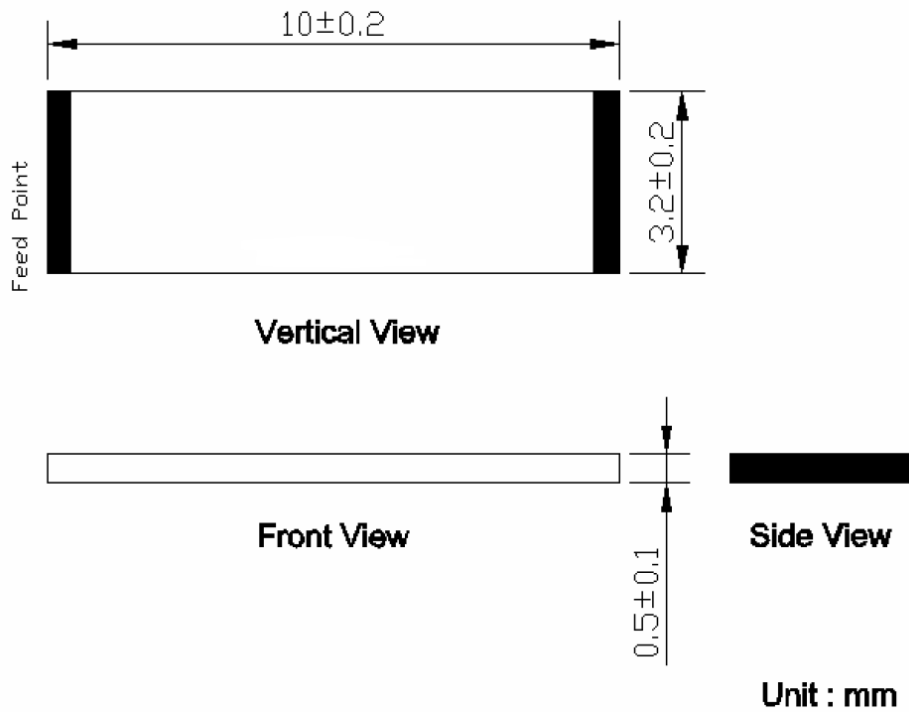

3.1 Test board with Antenna

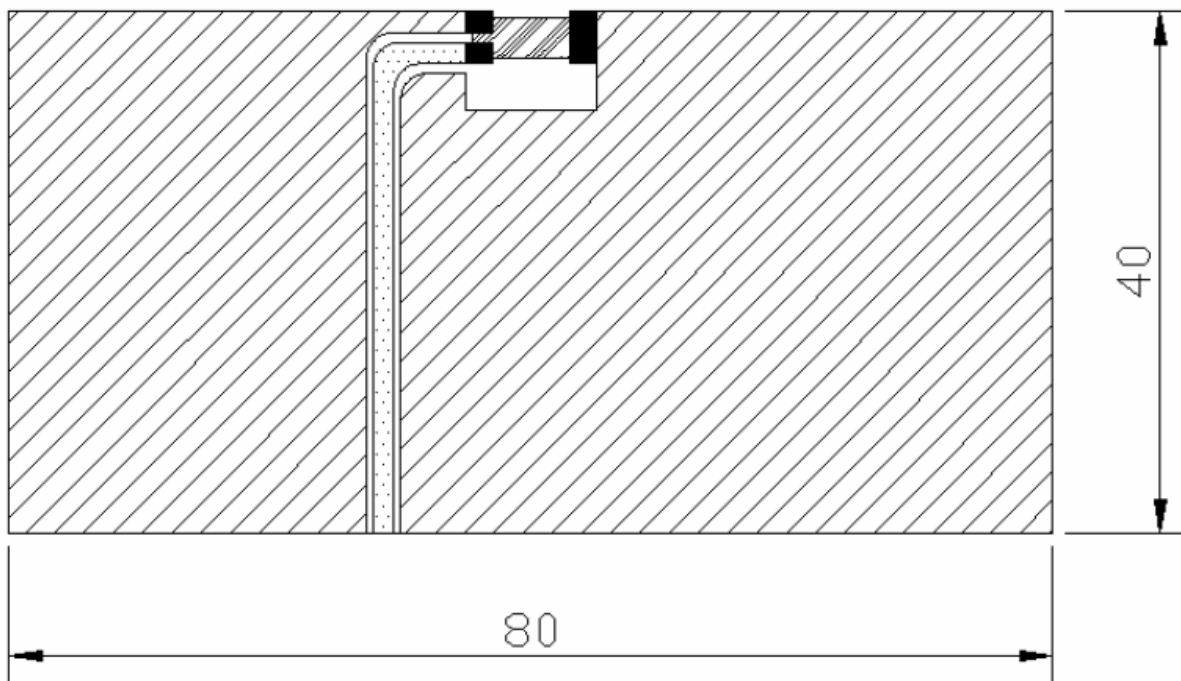

© All Rights Reserved

Taoglas Limited, Unit 7 Peare Campus, Moyne Business Park, Enniscorthy, Co. Wexford, Ireland  
info@taoglas.com

+353 53 9169500

www.taoglas.com



Specification

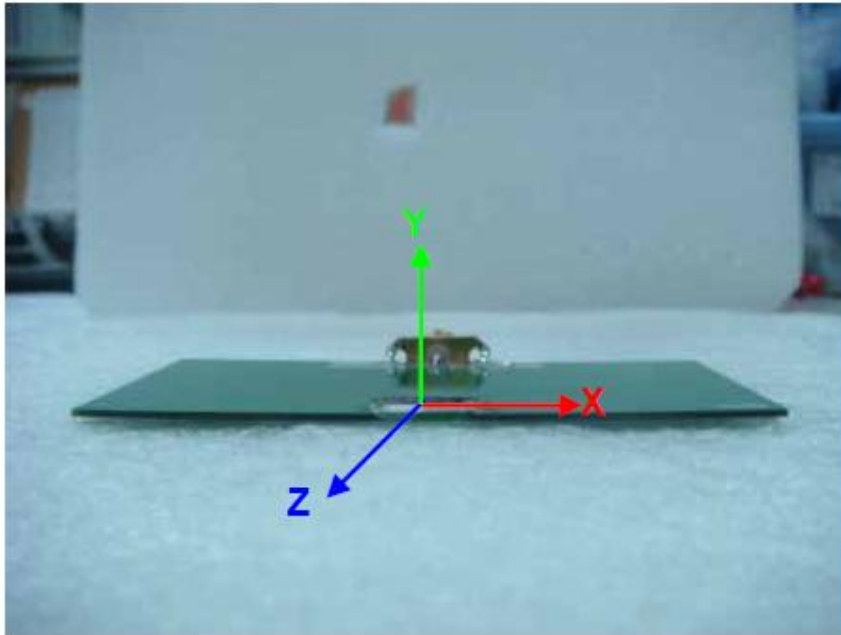

4.0 Electrical Characteristics (80\*40mm ground plane)

Return Loss ( $S_{11}$ )

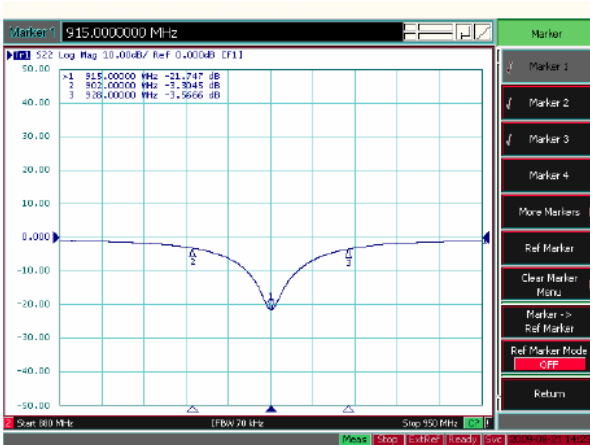

Smith chart

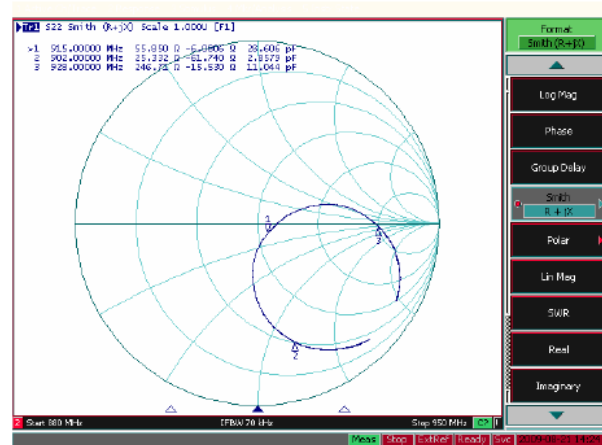



### 5.0 Radiation Pattern (Customize Design)

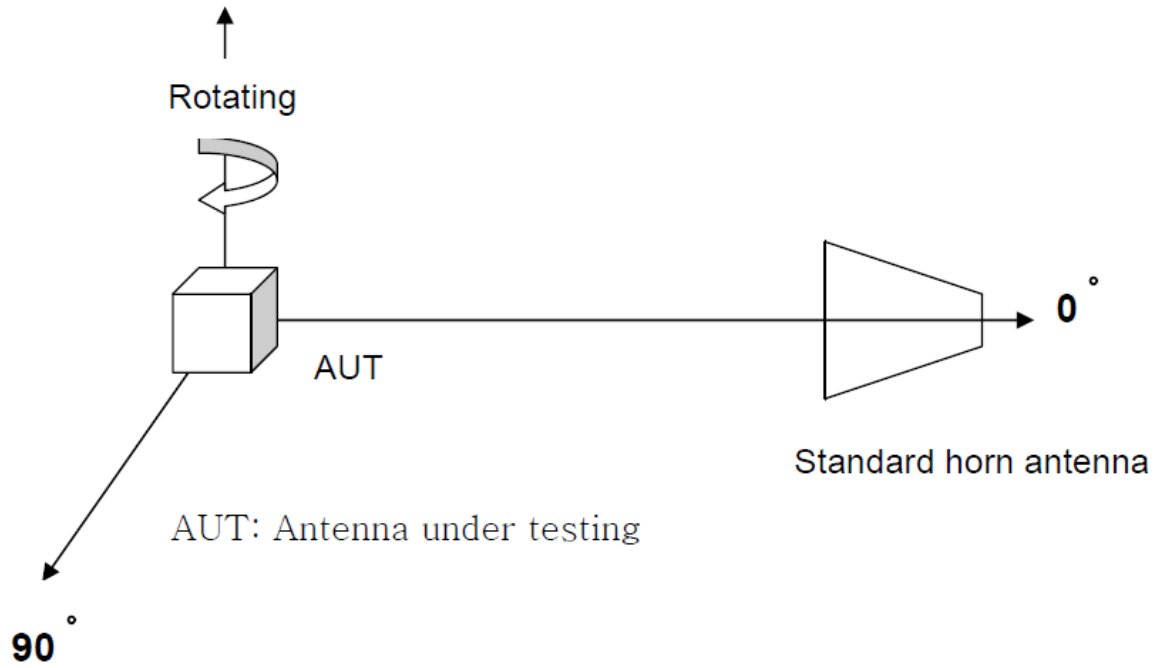



Specification

6.0 3D Gain Pattern

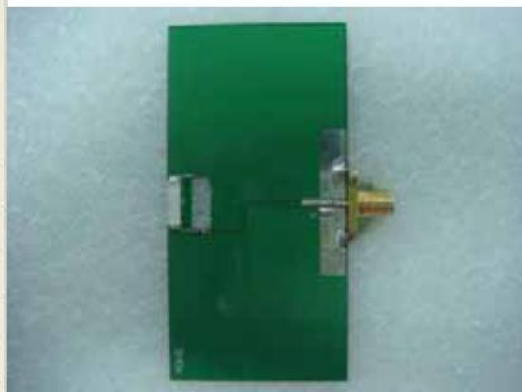
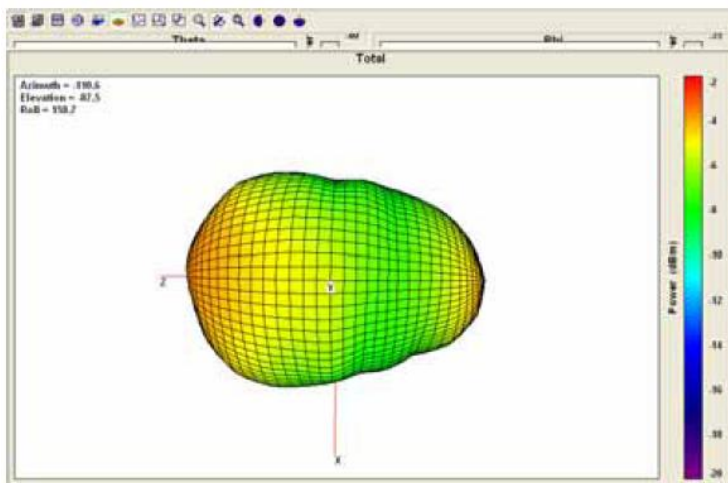
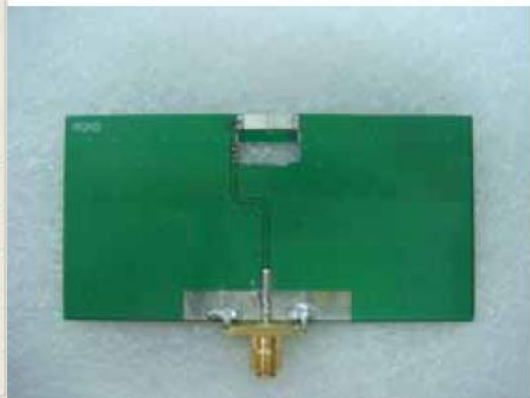
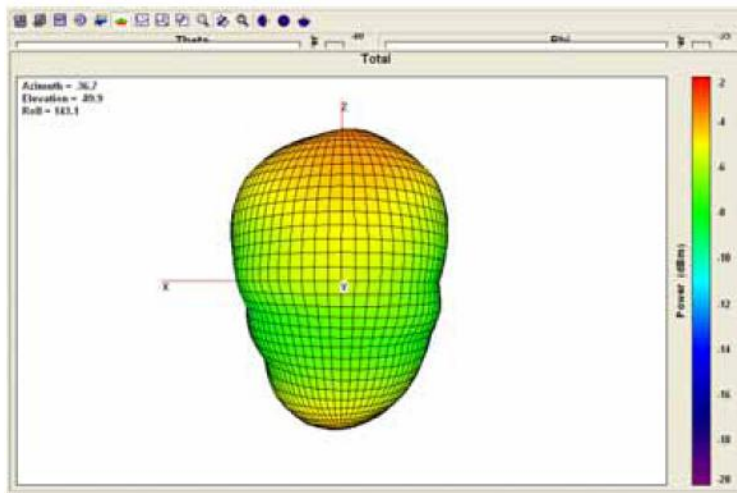
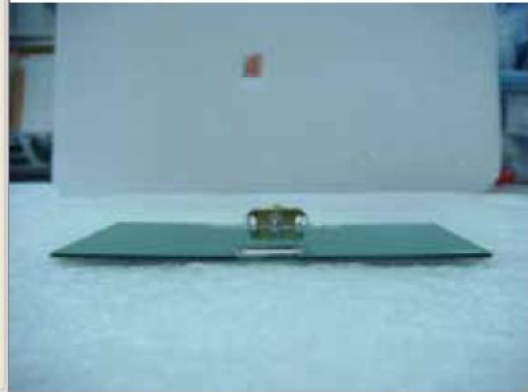
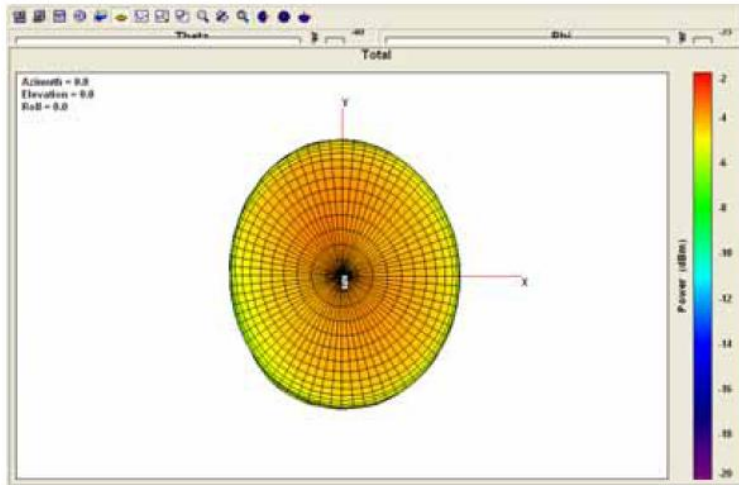

© All Rights Reserved

Taoglas Limited, Unit 7 Peare Campus, Moyne Business Park, Enniscorthy, Co. Wexford, Ireland  
info@taoglas.com

+353 53 9169500

www.taoglas.com



## Specification

## 6.1 Efficiency &amp; Peak Gain vs. Frequency

Frequency(MHz)	Efficiency(dB)	Efficiency (%)	Peak Gain (dBm)
900	-6.08	24.67	-3.46
901	-5.7	26.9	-3.1
902	-5.33	29.29	-2.75
903	-4.96	31.93	-2.35
904	-4.57	34.91	-2
905	-4.17	38.31	-1.62
906	-3.74	42.22	-1.2
907	-3.33	46.45	-0.77
908	-2.95	50.71	-0.4
909	-2.61	54.87	-0.07
910	-2.31	58.73	0.21
911	-2.08	61.95	0.43
912	-1.87	65.04	0.63
913	-1.73	67.18	0.77
914	-1.62	68.94	0.87
915	-1.56	69.78	0.92
916	-1.59	69.33	0.88
917	-1.68	67.94	0.79
918	-1.84	65.48	0.62
919	-2.06	62.29	0.4
920	-2.31	58.73	0.12
921	-2.58	55.18	-0.16
922	-2.86	51.79	-0.46
923	-3.16	48.33	-0.75
924	-3.48	44.85	-1.11
925	-3.82	41.5	-1.46
926	-4.19	38.08	-1.84
927	-4.56	34.98	-2.24
928	-4.92	32.21	-2.57
929	-5.29	29.61	-2.97
930	-5.6	27.55	-3.3



Specification

7.0 Layout Guide

a. Solder Land Pattern:

Land pattern for soldering (black marking areas) is as shown below. Depending on Customer's requirement, matching circuit as shown below is also recommended. The footprint size is 11\*10.2mm and the antenna requires clearance.

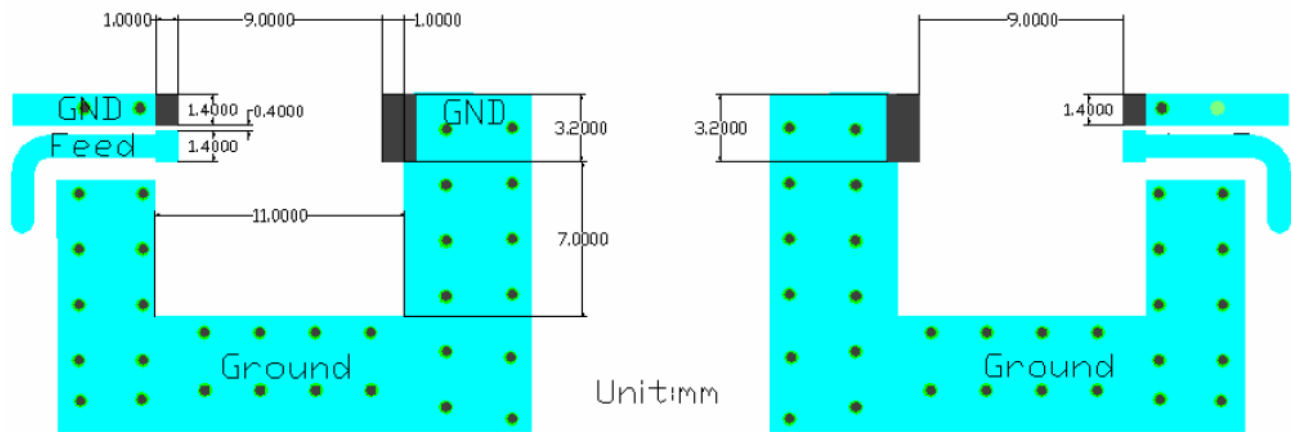

Top View

Back View





Specification

8.0 Packing

- (1) Quantity/Reel: 6000pcs/Reel
- (2) Plastic Tape

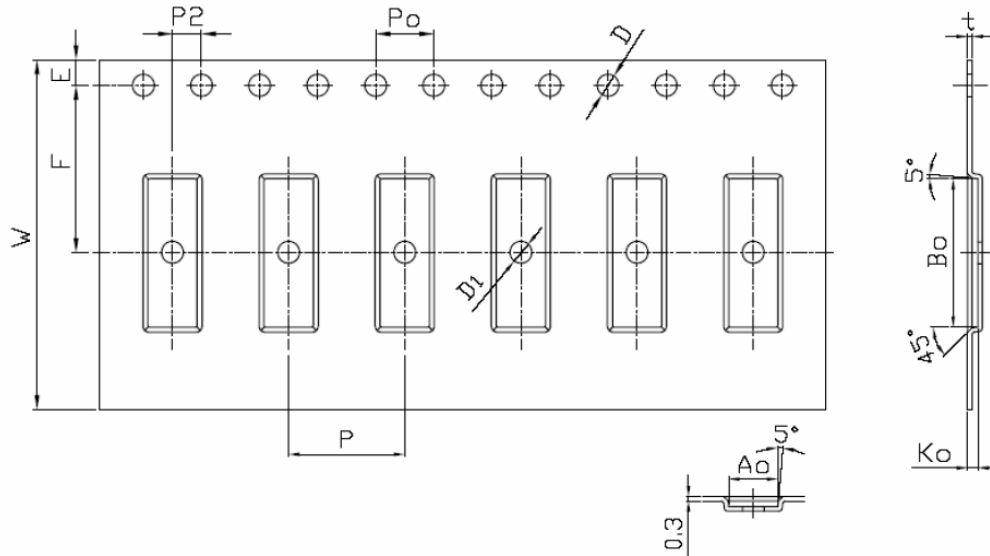

1. Cumulative tolerance of 10 sprocket hole pitch:  $\pm 0.20\text{mm}$
2. Carrier camber not to exceed 1mm in 250mm
3. Ao and Bo measured on a plane 0.3mm above the bottom of the pocket.
4. Ko measured from a plane on the inside bottom of the pocket to the top surface of the carrier.
5. All dimensions meet EIA-481-B requirements.
6. Material:  Clear Non Anti-Static Polystyrene.  
 Black Conductive Polystyrene.

7.1 Tape Dimensions (unit: mm)

Feature	Specifications	Tolerances
W	24	$\pm 0.30$
P	8	$\pm 0.10$
E	1.75	$\pm 0.10$
F	11.5	$\pm 0.10$
P2	2	$\pm 0.10$
D	1.5	$\pm 0.10$
D1	1.5	$\pm 0.10$
Po	4	$\pm 0.20$
10Po	40	$\pm 0.10$

7.2 Pocket Dimensions (unit: mm)

Feature	Specifications	Tolerances
Ao	3.40	$\pm 0.10$
Bo	10.20	$\pm 0.10$
Ko	0.70	$\pm 0.10$
t	0.30	$\pm 0.05$