

### Product Dimensions

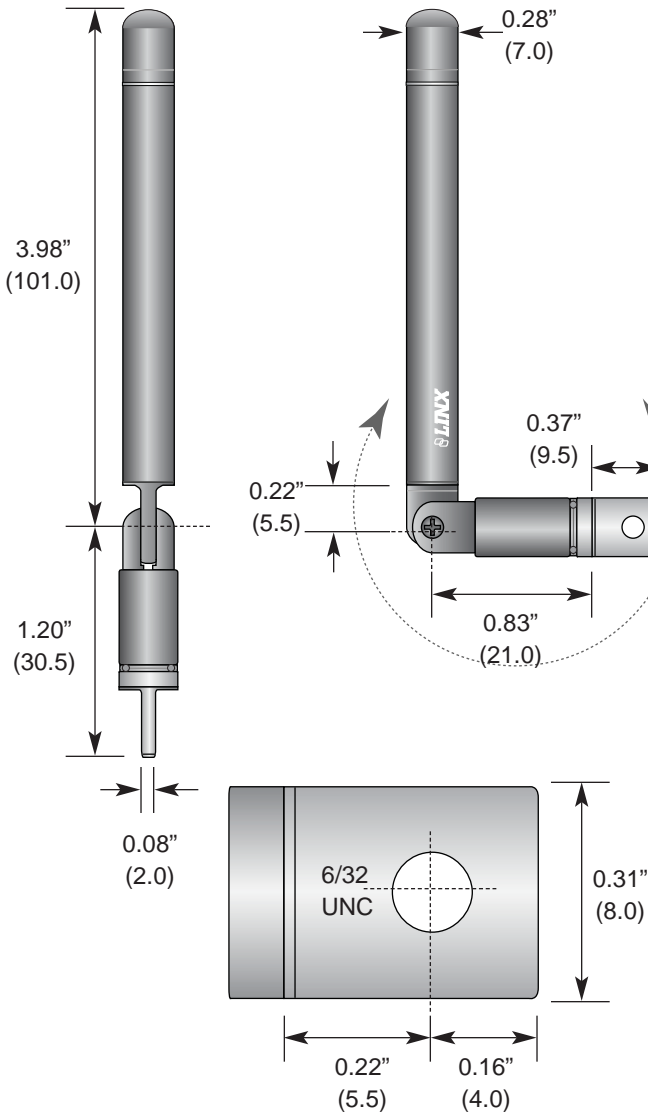

### Recommended Footprint

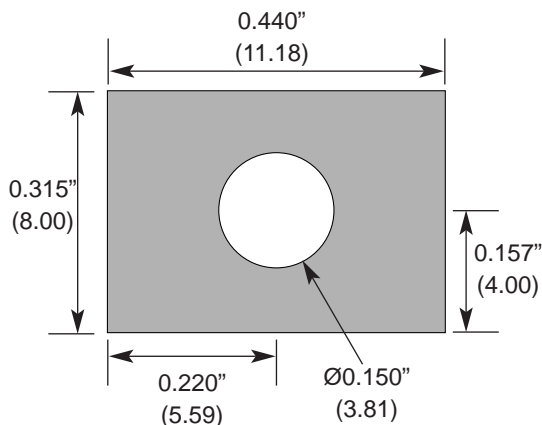

### Description



The RA Series offers maximum mounting and orientation flexibility in a cost-effective reduced-height package. The antenna's innovative articulating base allows it to tilt and rotate for optimum orientation. The RA mounts to a PCB via a single screw and meets Part 15 requirements.

### Features

- Low cost
  - Reduced-height helical whip
  - Tilts and rotates
  - Excellent performance
  - Omni-directional pattern
  - Screw-mount
  - Use with plastic\* or metal enclosures
- \* Requires proximity ground plane

### Electrical Specifications

- Center Freq. 315MHz
- Bandwidth 8MHz
- Wavelength 1/4-wave
- VSWR <2.0 typ. at center
- Impedance 50 ohms
- Connection Screw-mount

Electrical specifications and plots measured on 2.5" x 4" reference ground plane

### Ordering Information

- ANT-315-PW-RA

### VSWR Graph

