

LOC	DIST	REVISIONS					
E	B	P	LTR	DESCRIPTION	DATE	DWN	APVD
			BA	NEW RELEASE	27-Sep-08	SM	St.P

FOR FURTHER INFORMATION SEE DATA SHEET FOR
CPF SERIES-THIN FILM PRECISION CHIP RESISTORS

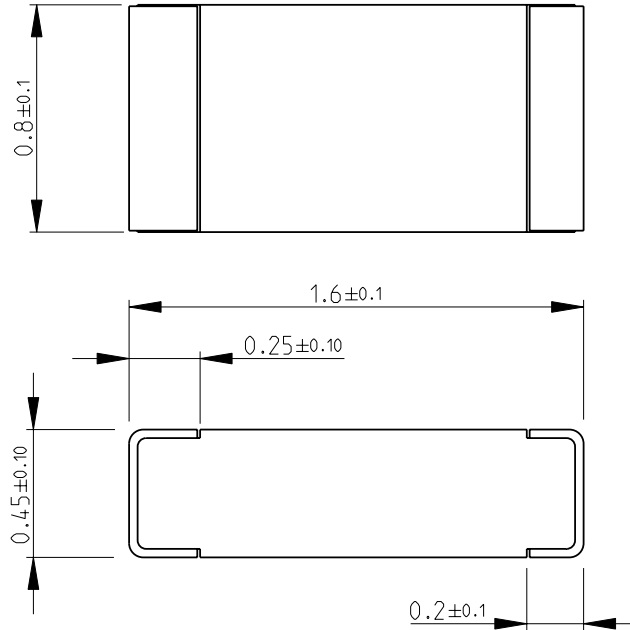

RoHS Compliant

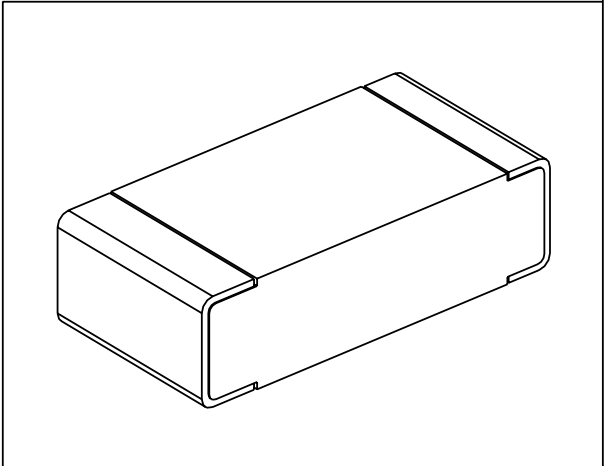

2008

RELEASED FOR PUBLICATION

THIS DRAWING IS UNPUBLISHED.

© COPYRIGHT 2008 BY TYCO ELECTRONICS CORPORATION. ALL RIGHTS RESERVED.

DIMENSIONS: mm		DWN SUBHASH.M	27-Sep-08	MATERIAL	-	FINISH	-
TOLERANCES UNLESS OTHERWISE SPECIFIED: 0 PLC ±0.2 1 PLC ±0.1 2 PLC ±- 3 PLC ±- 4 PLC ±- ANGLES ±5°		CHK PRAKASH.S	27-Sep-08	Tyco Electronics Corporation Dorcan, Swindon, SN3 5HH			
		APVD STEPHEN.P	27-Sep-08				
		PRODUCT SPEC	-	NAME THIN FILM PRECISION CHIP RESISTORS SERIES CPF 0603			
		APPLICATION SPEC	-	SIZE	CAGE CODE	DRAWING NO	RESTRICTED TO
		WEIGHT	-	A 4	00779	©= 1879222	-
CUSTOMER DRAWING				SCALE	40:1	SHEET	1 OF 1
						REV	BA