

Heterojunction Bipolar Transistor Technology (InGaP HBT)

Broadband High Linearity Amplifier

The MMG3013NT1 is a General Purpose Amplifier that is internally input matched and internally output matched. It is designed for a broad range of Class A, small-signal, high linearity, general purpose applications. It is suitable for applications with frequencies from 0 to 6000 MHz such as Cellular, PCS, BWA, WLL, PHS, CATV, VHF, UHF, UMTS and general small-signal RF.

Features

- Frequency: 0-6000 MHz
- P1dB: 20.5 dBm @ 900 MHz
- Small-Signal Gain: 20 dB @ 900 MHz
- Third Order Output Intercept Point: 36 dBm @ 900 MHz
- Single 5 Volt Supply
- Internally Matched to 50 Ohms
- Low Cost SOT-89 Surface Mount Package
- RoHS Compliant
- In Tape and Reel. T1 Suffix = 1000 Units per 12 mm, 7 inch Reel.

MMG3013NT1

**0-6000 MHz, 20 dB
 20.5 dBm
 InGaP HBT**

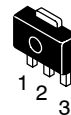

**CASE 1514-02, STYLE 1
 SOT-89
 PLASTIC**

Table 1. Typical Performance (1)

Characteristic	Symbol	900 MHz	2140 MHz	3500 MHz	Unit
Small-Signal Gain (S21)	G _p	20	17	14.5	dB
Input Return Loss (S11)	IRL	-17	-19	-15	dB
Output Return Loss (S22)	ORL	-11	-9	-12	dB
Power Output @1dB Compression	P1db	20.5	20.5	19	dBm
Third Order Output Intercept Point	IP3	36	34	32	dBm

1. V_{CC} = 5 Vdc, T_C = 25°C, 50 ohm system

Table 2. Maximum Ratings

Rating	Symbol	Value	Unit
Supply Voltage	V _{CC}	7	V
Supply Current	I _{CC}	300	mA
RF Input Power	P _{in}	12	dBm
Storage Temperature Range	T _{stg}	-65 to +150	°C
Junction Temperature (2)	T _J	150	°C

2. For reliable operation, the junction temperature should not exceed 150°C.

Table 3. Thermal Characteristics (V_{CC} = 5 Vdc, I_{CC} = 90 mA, T_C = 25°C)

Characteristic	Symbol	Value (3)	Unit
Thermal Resistance, Junction to Case	R _{θJC}	42	°C/W

3. Refer to AN1955, *Thermal Measurement Methodology of RF Power Amplifiers*. Go to <http://www.freescale.com/rf>. Select Documentation/Application Notes - AN1955.

NOT RECOMMENDED FOR NEW DESIGN

NOT RECOMMENDED FOR NEW DESIGN

Table 4. Electrical Characteristics ($V_{CC} = 5$ Vdc, 900 MHz, $T_C = 25^\circ\text{C}$, 50 ohm system, in Freescale Application Circuit)

Characteristic		Symbol	Min	Typ	Max	Unit
Small-Signal Gain (S21)	900 MHz 2140 MHz	G_p	19.3 16	20 17	— —	dB
Input Return Loss (S11)		IRL	—	-17	—	dB
Output Return Loss (S22)		ORL	—	-11	—	dB
Power Output @ 1dB Compression		P1dB	—	20.5	—	dBm
Third Order Output Intercept Point		IP3	—	36	—	dBm
Noise Figure		NF	—	4	—	dB
Supply Current (1)		I_{CC}	80	90	110	mA
Supply Voltage (1)		V_{CC}	—	5	—	V

1. For reliable operation, the junction temperature should not exceed 150°C .

Table 5. Functional Pin Description

Pin Number	Pin Function
1	RF _{in}
2	Ground
3	RF _{out} /DC Supply

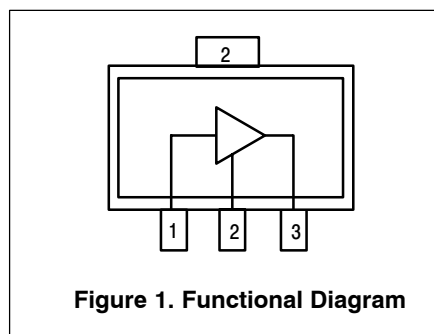

Table 6. ESD Protection Characteristics

Test Methodology	Class
Human Body Model (per JESD 22-A114)	1A (Minimum)
Machine Model (per EIA/JESD 22-A115)	A (Minimum)
Charge Device Model (per JESD 22-C101)	IV (Minimum)

Table 7. Moisture Sensitivity Level

Test Methodology	Rating	Package Peak Temperature	Unit
Per JESD 22-A113, IPC/JEDEC J-STD-020	1	260	°C

50 OHM TYPICAL CHARACTERISTICS

NOT RECOMMENDED FOR NEW DESIGN

NOT RECOMMENDED FOR NEW DESIGN

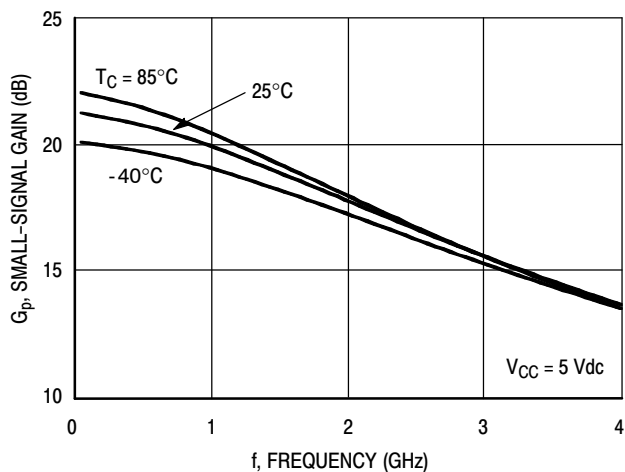

Figure 2. Small-Signal Gain (S21) versus Frequency

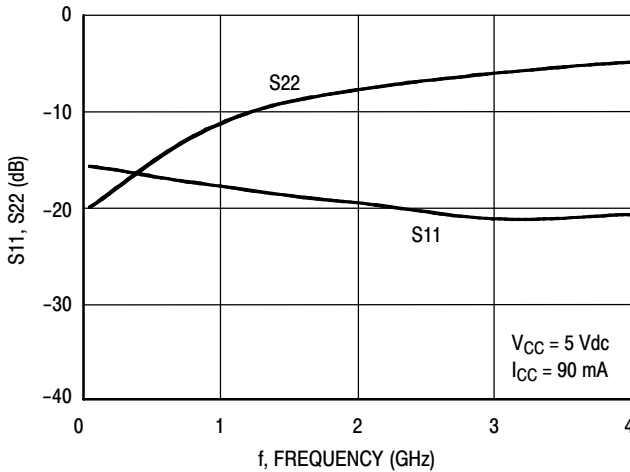

Figure 3. Input/Output Return Loss versus Frequency

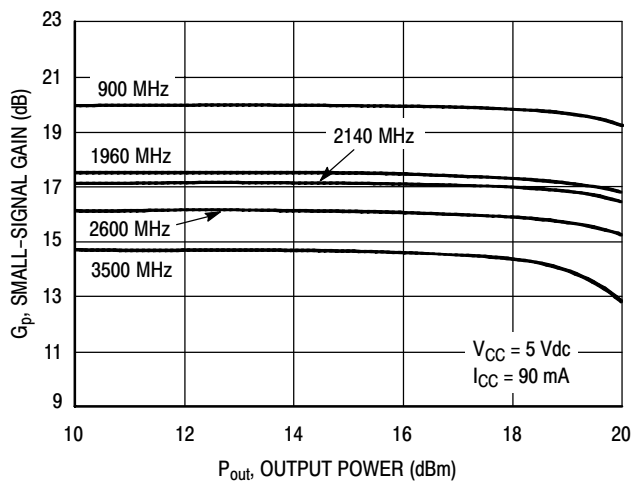

Figure 4. Small-Signal Gain versus Output Power

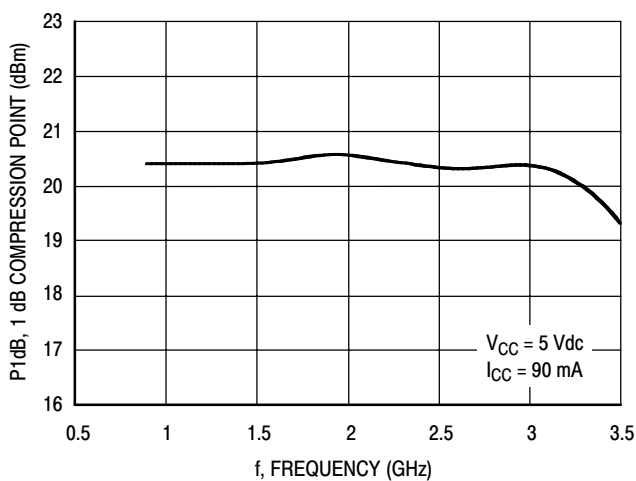

Figure 5. P1dB versus Frequency

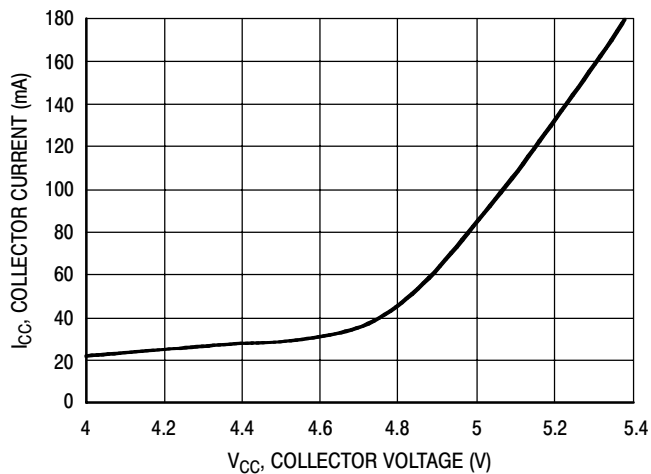

Figure 6. Collector Current versus Collector Voltage

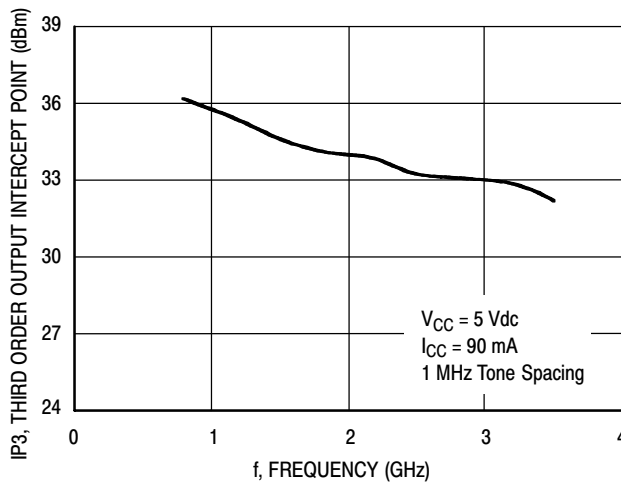

Figure 7. Third Order Output Intercept Point versus Frequency

50 OHM TYPICAL CHARACTERISTICS

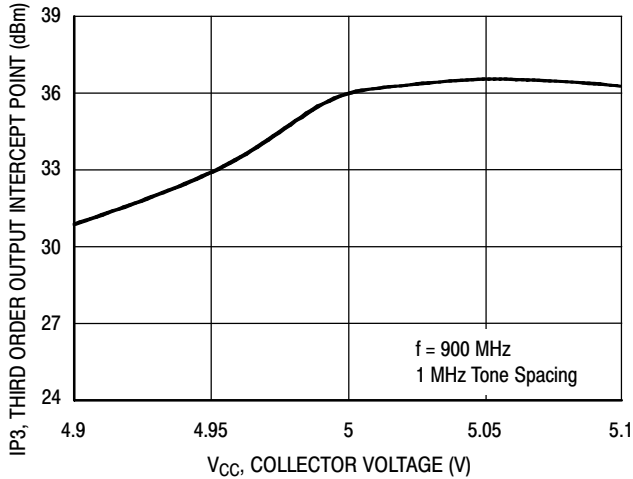

Figure 8. Third Order Output Intercept Point versus Collector Voltage

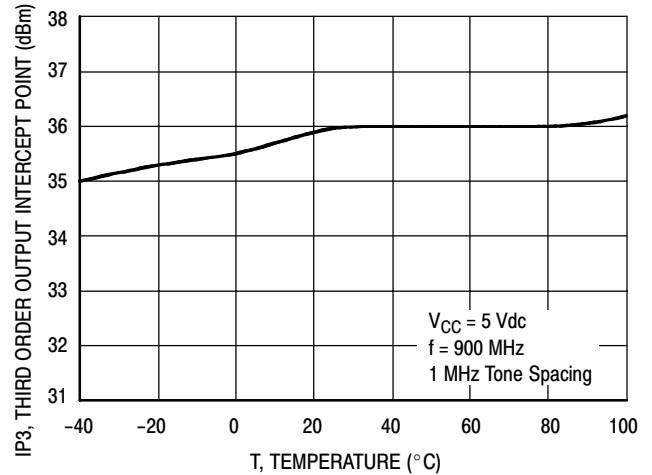

Figure 9. Third Order Output Intercept Point versus Case Temperature

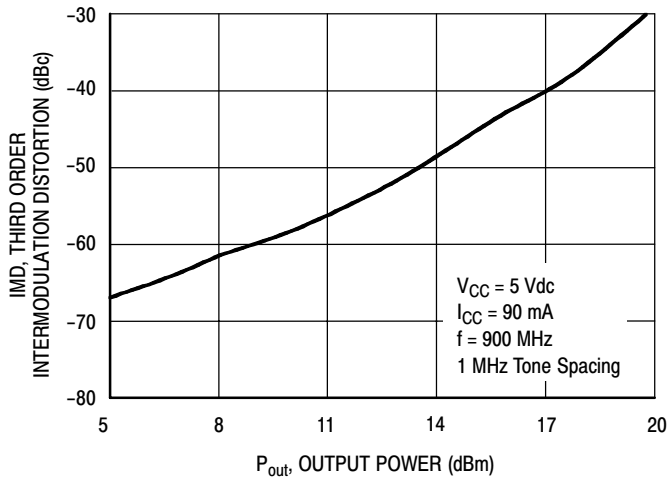
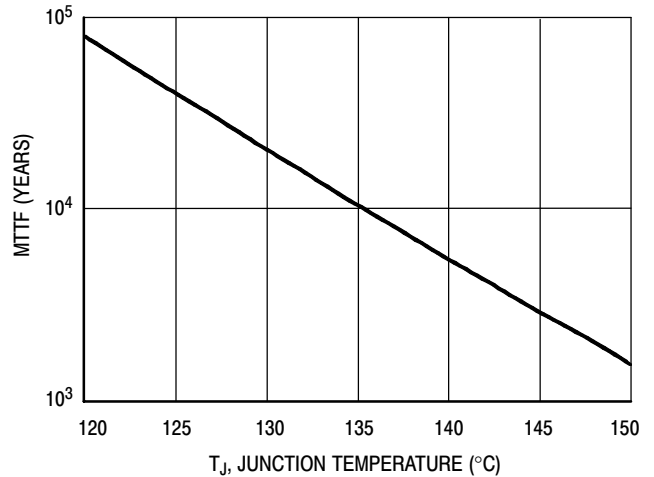

Figure 10. Third Order Intermodulation versus Output Power



NOTE: The MTTF is calculated with $V_{CC} = 5 \text{ Vdc}$, $I_{CC} = 90 \text{ mA}$

Figure 11. MTTF versus Junction Temperature

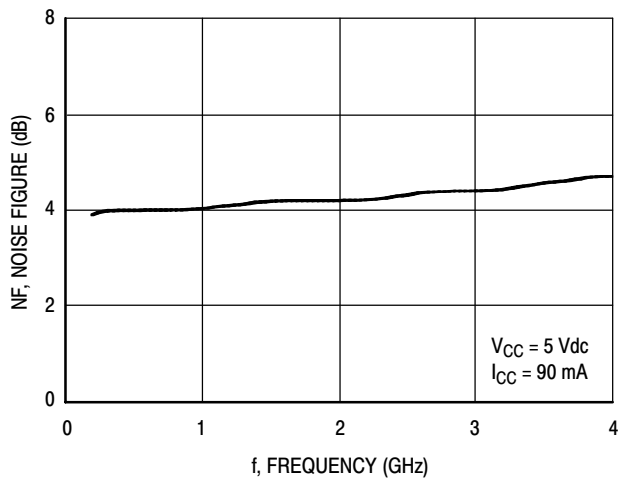

Figure 12. Noise Figure versus Frequency

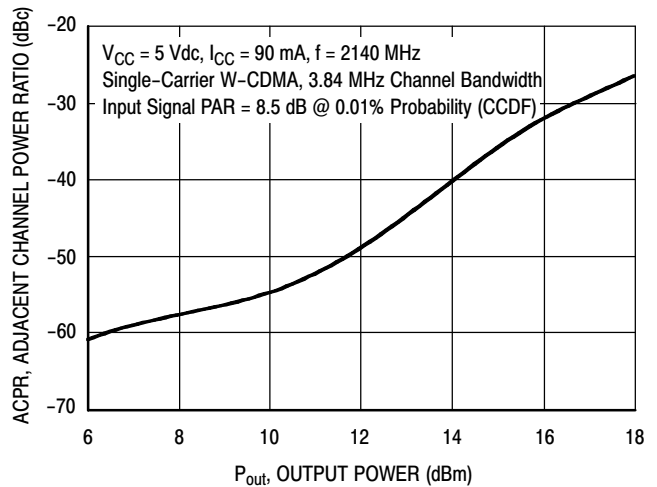

Figure 13. Single-Carrier W-CDMA Adjacent Channel Power Ratio versus Output Power

MMG3013NT1

NOT RECOMMENDED FOR NEW DESIGN

NOT RECOMMENDED FOR NEW DESIGN

50 OHM APPLICATION CIRCUIT: 40-800 MHz

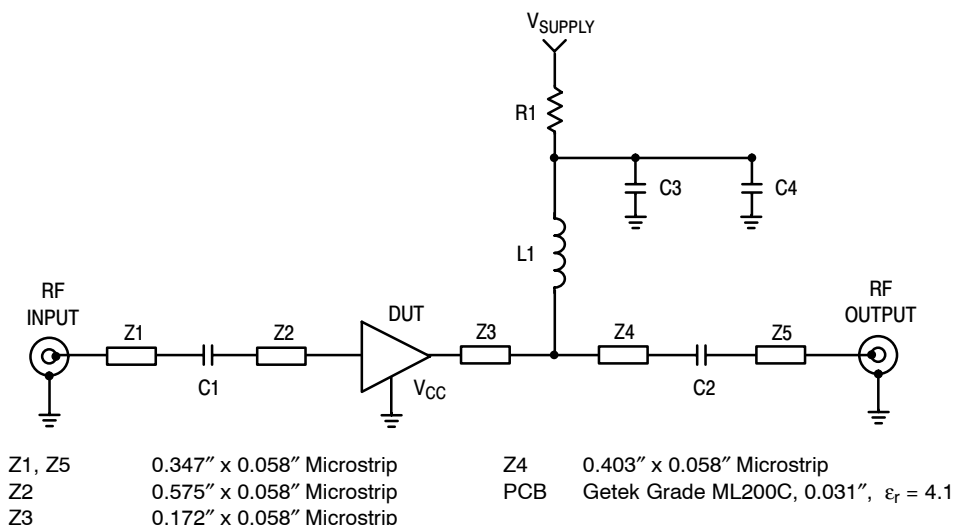

Figure 14. 50 Ohm Test Circuit Schematic

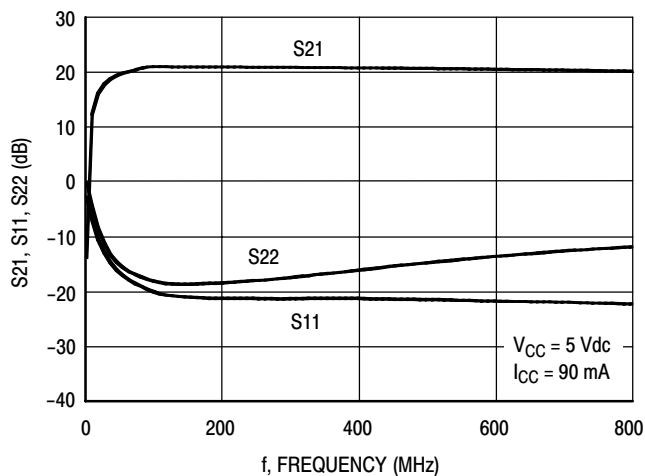

Figure 15. S21, S11 and S22 versus Frequency

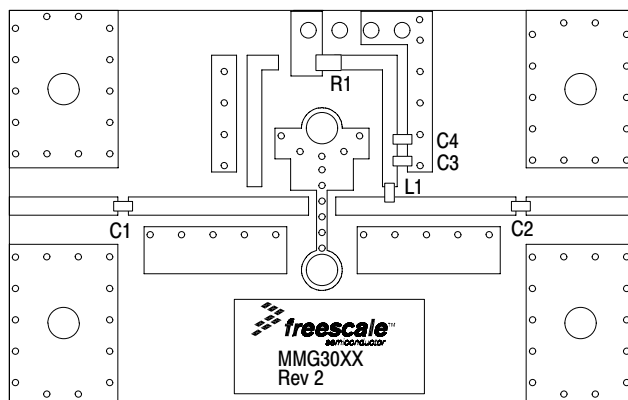

Figure 16. 50 Ohm Test Circuit Component Layout

Table 8. 50 Ohm Test Circuit Component Designations and Values

Part	Description	Part Number	Manufacturer
C1, C2	0.01 μ F Chip Capacitors	C0603C103J5RAC	Kemet
C3	0.1 μ F Chip Capacitor	C0603C104J5RAC	Kemet
C4	1 μ F Chip Capacitor	C0603C105J5RAC	Kemet
L1	470 nH Chip Inductor	BK2125HM471 - T	Taiyo Yuden
R1	0 Ω Chip Resistor	ERJ3GEY0R00V	Panasonic

NOT RECOMMENDED FOR NEW DESIGN

NOT RECOMMENDED FOR NEW DESIGN

50 OHM APPLICATION CIRCUIT: 800-3600 MHz

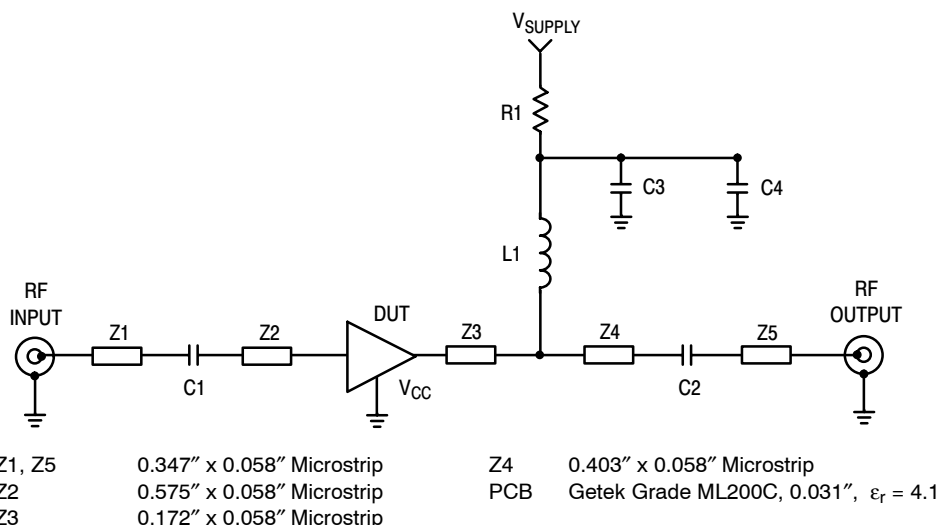

Figure 17. 50 Ohm Test Circuit Schematic

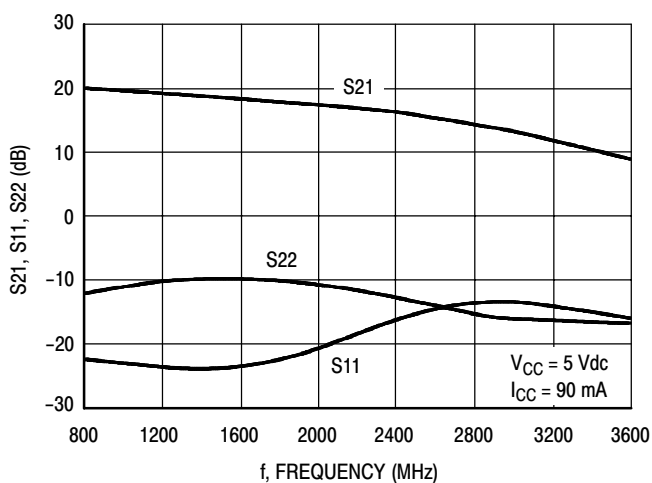

Figure 18. S21, S11 and S22 versus Frequency

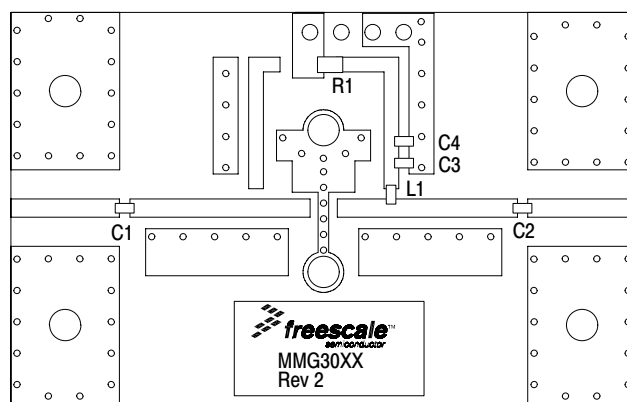

Figure 19. 50 Ohm Test Circuit Component Layout

Table 9. 50 Ohm Test Circuit Component Designations and Values

Part	Description	Part Number	Manufacturer
C1, C2	150 pF Chip Capacitors	C0603C151J5RAC	Kemet
C3	0.1 μ F Chip Capacitor	C0603C104J5RAC	Kemet
C4	1 μ F Chip Capacitor	C0603C105J5RAC	Kemet
L1	56 nH Chip Inductor	HK160856NJ-T	Taiyo Yuden
R1	0 Ω Chip Resistor	ERJ3GEY0R00V	Panasonic

50 OHM TYPICAL CHARACTERISTICS

Table 10. Common Emitter S-Parameters ($V_{CC} = 5 \text{ Vdc}$, $I_{CC} = 90 \text{ mA}$, $T_C = 25^\circ\text{C}$, 50 Ohm System)

f MHz	S ₁₁		S ₂₁		S ₁₂		S ₂₂	
	S ₁₁	∠ φ	S ₂₁	∠ φ	S ₁₂	∠ φ	S ₂₂	∠ φ
100	0.162717	171.108	11.479238	174.775	0.069393	-1.296	0.106264	-133.221
150	0.160561	167.971	11.415032	171.459	0.069131	-1.887	0.112247	-134.322
200	0.160153	163.027	11.337210	168.606	0.068870	-2.702	0.118610	-135.449
250	0.157910	159.994	11.263950	165.874	0.068640	-3.308	0.127240	-136.522
300	0.155640	156.091	11.200930	163.101	0.068460	-3.908	0.134977	-137.648
350	0.152870	152.178	11.160790	160.282	0.068400	-4.523	0.144410	-138.763
400	0.150710	148.189	11.096270	157.597	0.068380	-5.134	0.154090	-139.895
450	0.148730	144.135	11.027770	154.845	0.068210	-5.794	0.164250	-140.998
500	0.145840	140.465	10.957540	152.097	0.068260	-6.391	0.174550	-142.085
550	0.143950	136.404	10.876040	149.449	0.068090	-6.918	0.185240	-143.132
600	0.141980	132.557	10.785240	146.811	0.068040	-7.57	0.195510	-144.211
650	0.140120	128.67	10.695820	144.176	0.068000	-8.199	0.206040	-145.338
700	0.138450	124.924	10.604510	141.59	0.067790	-8.743	0.216910	-146.461
750	0.137510	121.228	10.504830	139.003	0.067690	-9.285	0.227810	-147.659
800	0.136570	117.62	10.400340	136.446	0.067590	-9.831	0.238140	-148.902
850	0.134433	114.245	10.295550	133.89	0.067520	-10.415	0.248290	-150.118
900	0.132707	110.998	10.186390	131.409	0.067420	-10.866	0.258400	-151.55
950	0.131087	107.842	10.073620	128.963	0.067380	-11.449	0.268360	-153.097
1000	0.129567	104.859	9.965510	126.525	0.067220	-11.901	0.277810	-154.786
1050	0.128275	102.209	9.842290	124.132	0.067050	-12.399	0.287510	-156.435
1100	0.127137	99.637	9.725320	121.744	0.066970	-12.949	0.297010	-158.367
1150	0.125513	97.509	9.610100	119.381	0.066930	-13.483	0.306110	-160.411
1200	0.124020	95.409	9.485500	117.045	0.066790	-13.882	0.314950	-162.397
1250	0.122379	93.482	9.367530	114.76	0.066840	-14.46	0.323700	-164.386
1300	0.121234	91.761	9.251560	112.507	0.066710	-14.928	0.332570	-166.443
1350	0.120081	90.16	9.129800	110.251	0.066685	-15.375	0.339940	-168.554
1400	0.118817	88.664	9.011610	108.055	0.066670	-15.818	0.348650	-170.582
1450	0.116609	87.326	8.892430	105.876	0.066687	-16.365	0.356290	-172.695
1500	0.115374	86.23	8.772640	103.703	0.066764	-16.815	0.360061	-174.724
1550	0.113850	80.021	8.708890	101.399	0.066970	-17.493	0.364627	-177.374
1600	0.113120	77.212	8.598320	99.278	0.067057	-17.963	0.369410	-179.169
1650	0.112080	75.253	8.485180	97.137	0.067090	-18.477	0.374600	179.129
1700	0.111350	72.833	8.379040	95.075	0.067170	-18.984	0.380650	177.406
1750	0.110660	70.651	8.273700	93.021	0.067200	-19.462	0.386070	175.7
1800	0.110070	68.704	8.167240	90.99	0.067260	-19.938	0.391590	174.044
1850	0.109570	66.752	8.063390	88.942	0.067320	-20.42	0.396600	172.328
1900	0.108940	64.808	7.958390	86.97	0.067420	-20.891	0.402290	170.798
1950	0.107610	63.28	7.856150	84.972	0.067460	-21.389	0.407630	169.234
2000	0.106800	61.916	7.751440	83.012	0.067560	-21.917	0.412720	167.75
2050	0.106240	60.415	7.651320	81.047	0.067600	-22.347	0.418620	166.176
2100	0.104410	59.082	7.553170	79.114	0.067810	-22.888	0.423200	164.723
2150	0.103200	57.787	7.452840	77.223	0.067960	-23.444	0.428690	163.19
2200	0.102820	56.94	7.354920	75.325	0.067980	-23.91	0.433410	161.75
2250	0.101220	55.6	7.259510	73.436	0.068230	-24.487	0.438440	160.241

(continued)

NOT RECOMMENDED FOR NEW DESIGN

NOT RECOMMENDED FOR NEW DESIGN

50 OHM TYPICAL CHARACTERISTICS

Table 10. Common Emitter S-Parameters ($V_{CC} = 5 \text{ Vdc}$, $I_{CC} = 90 \text{ mA}$, $T_C = 25^\circ\text{C}$, 50 Ohm System) (continued)

f MHz	S ₁₁		S ₂₁		S ₁₂		S ₂₂	
	S ₁₁	∠φ	S ₂₁	∠φ	S ₁₂	∠φ	S ₂₂	∠φ
2300	0.100260	54.54	7.163530	71.577	0.068190	-24.984	0.442830	158.869
2350	0.098910	53.312	7.072340	69.734	0.068480	-25.485	0.447010	157.463
2400	0.097870	52.576	6.980770	67.882	0.068550	-26.108	0.451420	155.974
2450	0.096530	51.814	6.892310	66.059	0.068780	-26.694	0.457800	154.6
2500	0.095360	50.69	6.802480	64.259	0.068940	-27.154	0.460110	153.074
2550	0.094140	49.939	6.719330	62.461	0.069120	-27.644	0.464930	151.617
2600	0.093150	49.177	6.634260	60.65	0.069290	-28.295	0.469350	150.014
2650	0.092180	48.019	6.554070	58.859	0.069490	-28.971	0.473140	148.442
2700	0.091130	47.141	6.471630	57.062	0.069610	-29.561	0.477010	146.825
2750	0.090470	46.394	6.392370	55.299	0.069850	-30.111	0.481850	145.214
2800	0.089850	45.454	6.314980	53.505	0.070210	-30.649	0.485260	143.56
2850	0.088790	44.657	6.238550	51.724	0.070340	-31.402	0.489440	141.782
2900	0.088180	44.083	6.166300	50.021	0.070550	-32.044	0.494180	140.078
2950	0.087640	43.291	6.088480	48.207	0.070750	-32.738	0.497180	138.23
3000	0.086490	42.549	6.020040	46.489	0.071030	-33.388	0.501590	136.357
3050	0.087170	42.041	5.950380	44.764	0.071280	-34.097	0.505070	134.738
3100	0.086660	41.37	5.881680	43.022	0.071610	-34.666	0.509400	132.754
3150	0.086130	41.387	5.814190	41.268	0.071920	-35.528	0.514040	130.875
3200	0.086330	41.301	5.749680	39.547	0.072150	-36.302	0.518490	128.954
3250	0.086760	41.239	5.684930	37.829	0.072340	-36.943	0.523620	126.955
3300	0.086510	41.638	5.619060	36.098	0.072640	-37.799	0.525880	124.995
3350	0.086820	41.81	5.557890	34.368	0.072800	-38.546	0.530230	123.081
3400	0.087230	42.12	5.498110	32.629	0.073130	-39.319	0.534740	121.057
3450	0.087680	42.727	5.437290	30.936	0.073490	-40.144	0.538080	119.195
3500	0.087990	43.424	5.376810	29.22	0.073710	-40.92	0.542580	117.253
3550	0.088730	44.082	5.319060	27.529	0.073970	-41.673	0.546650	115.36
3600	0.089200	45.12	5.259990	25.838	0.074200	-42.467	0.550400	113.481

NOT RECOMMENDED FOR NEW DESIGN

NOT RECOMMENDED FOR NEW DESIGN

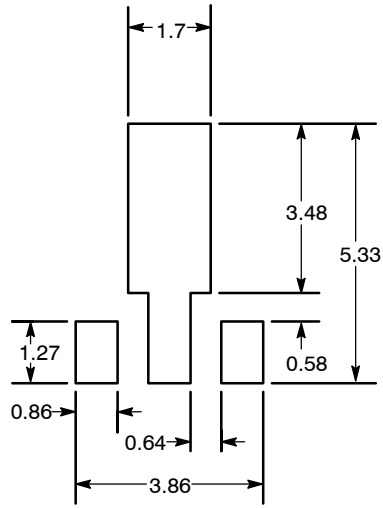

Recommended Solder Stencil

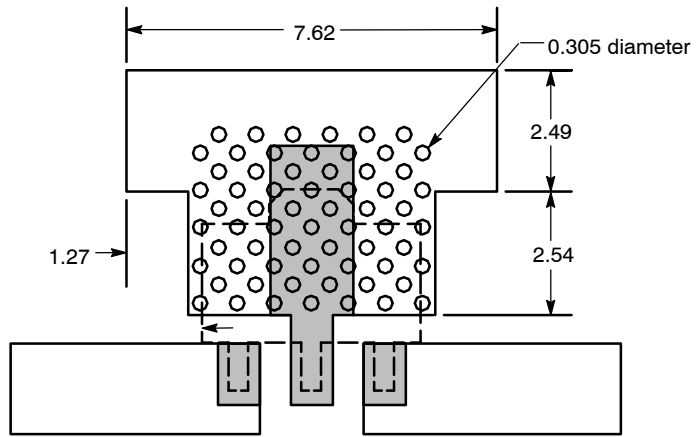

NOTES:

1. THERMAL AND RF GROUNDING CONSIDERATIONS SHOULD BE USED IN PCB LAYOUT DESIGN.
2. DEPENDING ON PCB DESIGN RULES, AS MANY VIAS AS POSSIBLE SHOULD BE PLACED ON THE LANDING PATTERN.
3. IF VIAS CANNOT BE PLACED ON THE LANDING PATTERN, THEN AS MANY VIAS AS POSSIBLE SHOULD BE PLACED AS CLOSE TO THE LANDING PATTERN AS POSSIBLE FOR OPTIMAL THERMAL AND RF PERFORMANCE.
4. RECOMMENDED VIA PATTERN SHOWN HAS 0.381 x 0.762 MM PITCH.

Figure 20. Recommended Mounting Configuration

PACKAGE DIMENSIONS

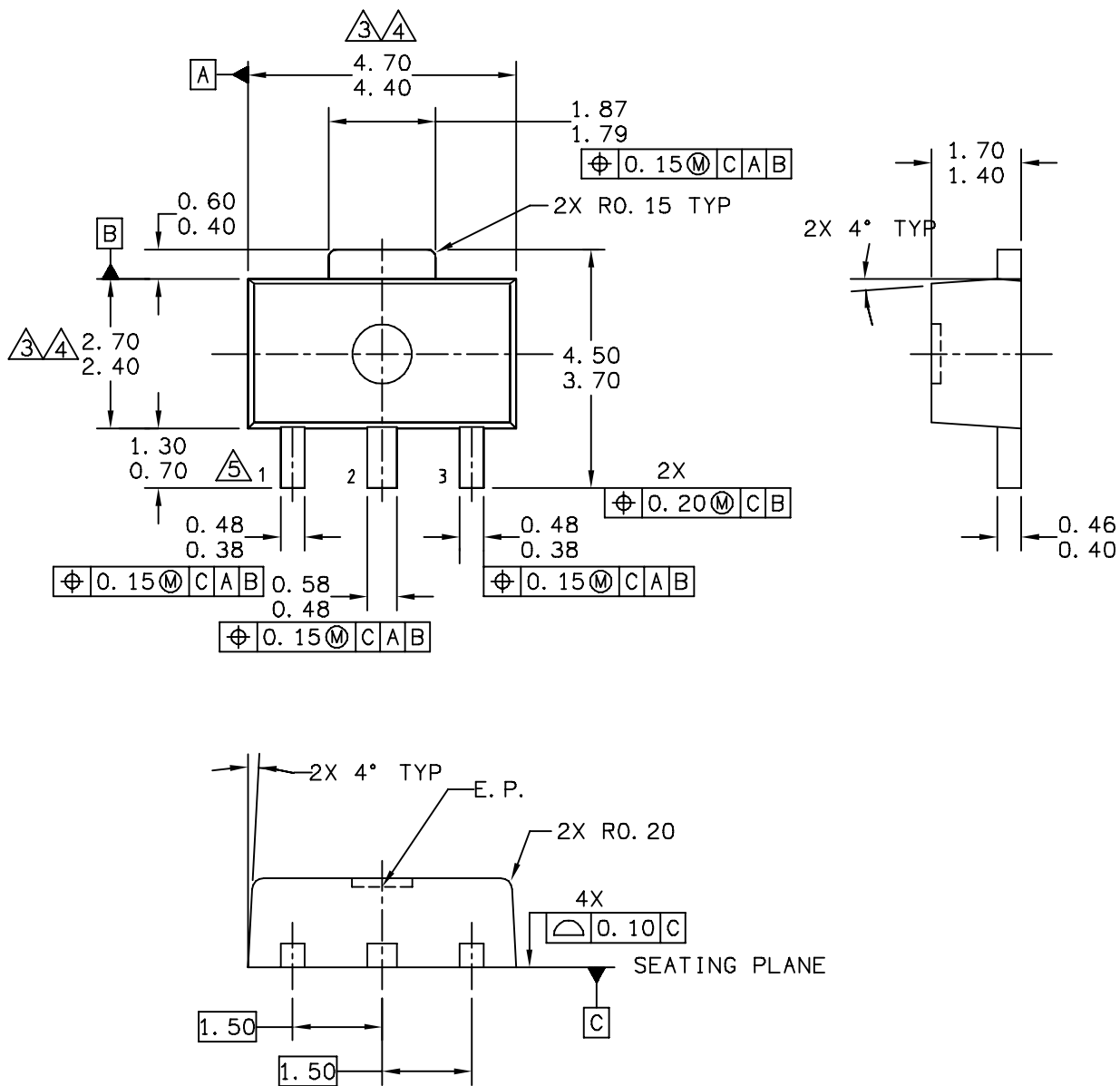

NOT RECOMMENDED FOR NEW DESIGN

NOT RECOMMENDED FOR NEW DESIGN

© FREESCALE SEMICONDUCTOR, INC. ALL RIGHTS RESERVED.	MECHANICAL OUTLINE	PRINT VERSION NOT TO SCALE	
TITLE: SOT-89, 4 LEAD, 4.5 X 2.5 PKG, 1.5 MM PITCH	DOCUMENT NO: 98ASA10586D	REV: D	
	CASE NUMBER: 1514-02	27 JUN 2007	
	STANDARD: NON-JEDEC		

MMG3013NT1

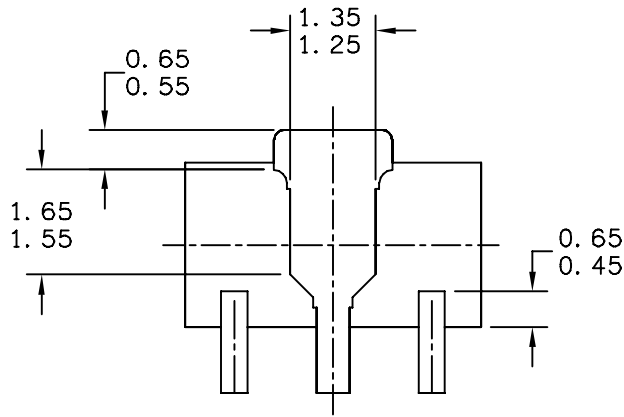

BOTTOM VIEW

CASE STYLE:

STYLE 1:

- PIN 1. RF INPUT
- PIN 2. GROUND
- PIN 3. RF OUTPUT

STYLE 2:

- PIN 1. GATE
- PIN 2. SOURCE
- PIN 3. DRAIN

© FREESCALE SEMICONDUCTOR, INC. ALL RIGHTS RESERVED.	MECHANICAL OUTLINE	PRINT VERSION NOT TO SCALE	
TITLE: SOT-89, 4 LEAD, 4.5 X 2.5 PKG, 1.5 MM PITCH	DOCUMENT NO: 98ASA10586D	REV: D	
	CASE NUMBER: 1514-02	27 JUN 2007	
	STANDARD: NON-JEDEC		

NOTES:

- 1 DIMENSIONING AND TOLERANCING PER ASME Y14.5M – 1994.
- 2 ALL DIMENSIONS ARE IN MILLIMETERS.
- 3 DIMENSIONS DOES NOT INCLUDE MOLD FLASH. PROTRUSIONS OR GATE BURRS. MOLD FLASH, PROTRUSIONS OR GATE BURRS SHALL NOT EXCEED 0.5mm PER END. DIMENSION DOES NOT INCLUDE INTERLEAD FLASH OR PROTRUSION. INTERLEAD FLASH OR PROTRUSION SHALL NOT EXCEED 0.5 mm PER SIDE.
- 4 DIMENSION ARE DETERMINED AT THE OUTMOST EXTREMES OF THE PLASTIC BODY EXCLUSIVE OF MOLD FLASH, TIE BAR BURRS, GATE BURRS AND INTERLEAD FLASH, BUT INCLUDING ANY MISMATCH BETWEEN THE TOP AND BOTTOM OF THE PLASTIC BODY.
- 5 TERMINAL NUMBERS ARE SHOWN FOR REFERENCE ONLY.

© FREESCALE SEMICONDUCTOR, INC. ALL RIGHTS RESERVED.	MECHANICAL OUTLINE	PRINT VERSION NOT TO SCALE	
TITLE: SOT-89, 4 LEAD, 4.5 X 2.5 PKG, 1.5 MM PITCH	DOCUMENT NO: 98ASA10586D	REV: D	
	CASE NUMBER: 1514-02	27 JUN 2007	
	STANDARD: NON-JEDEC		

PRODUCT DOCUMENTATION

Refer to the following documents to aid your design process.

Application Notes

- AN1955: Thermal Measurement Methodology of RF Power Amplifiers
- AN3100: General Purpose Amplifier Biasing

REVISION HISTORY

The following table summarizes revisions to this document.

Revision	Date	Description
4	Mar. 2007	<ul style="list-style-type: none">• Corrected and updated Part Numbers in Tables 8 and 9, Component Designations and Values, to RoHS compliant part numbers, p. 6, 7
5	July 2007	<ul style="list-style-type: none">• Replaced Case Outline 1514-01 with 1514-02, Issue D, p. 1, 11-13. Case updated to add missing dimension for Pin 1 and Pin 3.
6	Mar. 2008	<ul style="list-style-type: none">• Removed Footnote 2, Continuous voltage and current applied to device, from Table 2, Maximum Ratings, p. 1• Corrected Fig. 13, Single-Carrier W-CDMA Adjacent Channel Power Ratio versus Output Power y-axis (ACPR) unit of measure to dBc, p. 5• Corrected S-Parameter table frequency column label to read "MHz" versus "GHz" and corrected frequency values from GHz to MHz, p. 8, 9

NOT RECOMMENDED FOR NEW DESIGN

NOT RECOMMENDED FOR NEW DESIGN

How to Reach Us:**Home Page:**

www.freescale.com

Web Support:

<http://www.freescale.com/support>

USA/Europe or Locations Not Listed:

Freescale Semiconductor, Inc.
Technical Information Center, EL516
2100 East Elliot Road
Tempe, Arizona 85284
+1-800-521-6274 or +1-480-768-2130
www.freescale.com/support

Europe, Middle East, and Africa:

Freescale Halbleiter Deutschland GmbH
Technical Information Center
Schatzbogen 7
81829 Muenchen, Germany
+44 1296 380 456 (English)
+46 8 52200080 (English)
+49 89 92103 559 (German)
+33 1 69 35 48 48 (French)
www.freescale.com/support

Japan:

Freescale Semiconductor Japan Ltd.
Headquarters
ARCO Tower 15F
1-8-1, Shimo-Meguro, Meguro-ku,
Tokyo 153-0064
Japan
0120 191014 or +81 3 5437 9125
support.japan@freescale.com

Asia/Pacific:

Freescale Semiconductor China Ltd.
Exchange Building 23F
No. 118 Jianguo Road
Chaoyang District
Beijing 100022
China
+86 010 5879 8000
support.asia@freescale.com

For Literature Requests Only:

Freescale Semiconductor Literature Distribution Center
P.O. Box 5405
Denver, Colorado 80217
1-800-441-2447 or 303-675-2140
Fax: 303-675-2150
LDCForFreescaleSemiconductor@hibbertgroup.com

Information in this document is provided solely to enable system and software implementers to use Freescale Semiconductor products. There are no express or implied copyright licenses granted hereunder to design or fabricate any integrated circuits or integrated circuits based on the information in this document.

Freescale Semiconductor reserves the right to make changes without further notice to any products herein. Freescale Semiconductor makes no warranty, representation or guarantee regarding the suitability of its products for any particular purpose, nor does Freescale Semiconductor assume any liability arising out of the application or use of any product or circuit, and specifically disclaims any and all liability, including without limitation consequential or incidental damages. "Typical" parameters that may be provided in Freescale Semiconductor data sheets and/or specifications can and do vary in different applications and actual performance may vary over time. All operating parameters, including "Typicals", must be validated for each customer application by customer's technical experts. Freescale Semiconductor does not convey any license under its patent rights nor the rights of others. Freescale Semiconductor products are not designed, intended, or authorized for use as components in systems intended for surgical implant into the body, or other applications intended to support or sustain life, or for any other application in which the failure of the Freescale Semiconductor product could create a situation where personal injury or death may occur. Should Buyer purchase or use Freescale Semiconductor products for any such unintended or unauthorized application, Buyer shall indemnify and hold Freescale Semiconductor and its officers, employees, subsidiaries, affiliates, and distributors harmless against all claims, costs, damages, and expenses, and reasonable attorney fees arising out of, directly or indirectly, any claim of personal injury or death associated with such unintended or unauthorized use, even if such claim alleges that Freescale Semiconductor was negligent regarding the design or manufacture of the part.

Freescale™ and the Freescale logo are trademarks of Freescale Semiconductor, Inc. All other product or service names are the property of their respective owners.

© Freescale Semiconductor, Inc. 2005-2008. All rights reserved.

