

Data Sheet

Description

The MSA-0520 is a high performance silicon bipolar Monolithic Microwave Integrated Circuit (MMIC) housed in a hermetic, BeO disk package for good thermal characteristics. This MMIC is designed for use as a general purpose 50Ω gain block. Typical applications include narrow and broad band IF and RF amplifiers in industrial and military applications.

The MSA-series is fabricated using Avago's 10 GHz f_T , 25 GHz f_{MAX} , silicon bipolar MMIC process which uses nitride self-alignment, ion implantation, and gold metallization to achieve excellent performance, uniformity and reliability. The use of an external bias resistor for temperature and current stability also allows bias flexibility.

Features

- Cascadable 50 Ω Gain Block
- High Output Power:
+23 dBm Typical $P_{1\text{ dB}}$ at 1.0 GHz
- Low Distortion:
33 dBm Typical IP_3 at 1.0 GHz
- 8.5 dB Typical Gain at 1.0 GHz
- Hermetic Metal/Beryllia Microstrip Package

200 mil BeO Package

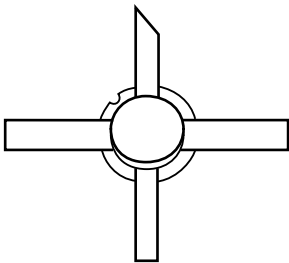

Typical Biasing Configuration

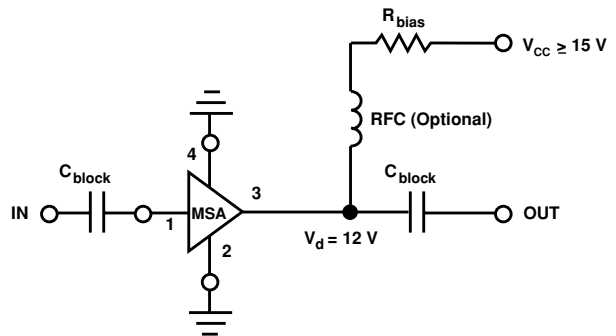

MSA-0520 Absolute Maximum Ratings

Parameter	Absolute Maximum ^[1]
Device Current	225 mA
Power Dissipation ^[2,3]	3.0 W
RF Input Power	+25 dBm
Junction Temperature	200°C
Storage Temperature	-65 to 200°C

Thermal Resistance^[2,4]:

$$\theta_{jc} = 25^{\circ}\text{C/W}$$

Notes:

1. Permanent damage may occur if any of these limits are exceeded.
2. $T_{\text{CASE}} = 25^{\circ}\text{C}$.
3. Derate at 40 mW/°C for $T_{\text{C}} > 125^{\circ}\text{C}$.
4. The small spot size of this technique results in a higher, though more accurate determination of θ_{jc} than do alternate methods.

Electrical Specifications^[1], $T_A = 25^{\circ}\text{C}$

Symbol	Parameters and Test Conditions: $I_d = 165 \text{ mA}$, $Z_0 = 50 \Omega$	Units	Min.	Typ.	Max.
$P_{1 \text{ dB}}$	Output Power at 1 dB Gain Compression $f = 1.0 \text{ GHz}$	dBm	21.0	23.0	
G_p	Power Gain ($ S_{21} ^2$) $f = 0.1 \text{ GHz}$	dB	7.5	8.5	9.5
ΔG_p	Gain Flatness $f = 0.1 \text{ to } 2.0 \text{ GHz}$	dB		± 0.75	
$f_{3 \text{ dB}}$	3 dB Bandwidth ^[2]	GHz		2.8	
VSWR	Input VSWR $f = 0.1 \text{ to } 2.0 \text{ GHz}$			2.0:1	
	Output VSWR $f = 0.1 \text{ to } 2.0 \text{ GHz}$			2.5:1	
IP_3	Third Order Intercept Point $f = 1.0 \text{ GHz}$	dBm		33.0	
$NF_{50 \Omega}$	50 Ω Noise Figure $f = 1.0 \text{ GHz}$	dB		6.5	
t_D	Group Delay $f = 1.0 \text{ GHz}$	psec		170	
V_d	Device Voltage	V	10.5	12.0	13.5
dV/dT	Device Voltage Temperature Coefficient	mV/°C		-16.0	

Notes:

1. The recommended operating current range for this device is 80 to 200 mA. Typical performance as a function of current is on the following page.
2. Referenced from 0.1 GHz Gain (GP).

MSA-0520 Typical Scattering Parameters ($T_A = 25^\circ\text{C}$, $I_d = 165\text{ mA}$)

Freq. MHz	S_{11}			S_{21}			S_{12}			S_{22}			k
	Mag	Ang	dB	Mag	Ang	dB	Mag	Ang	Mag	Ang	Mag	Ang	
5	.57	-38	14.4	5.25	165	-19.4	.107	38	.67	-35	0.57		
25	.25	-90	10.7	3.42	160	-14.9	.180	17	.29	-81	0.93		
50	.15	-111	9.5	2.97	163	-14.4	.190	9	.18	-97	1.10		
100	.11	-138	8.9	2.80	166	-14.2	.195	3	.11	-113	1.16		
200	.10	-152	8.8	2.75	163	-14.1	.197	1	.10	-125	1.17		
400	.10	-152	8.7	2.72	152	-14.1	.198	-2	.14	-123	1.16		
600	.11	-147	8.6	2.70	140	-14.0	.199	-4	.18	-123	1.14		
800	.13	-142	8.5	2.67	128	-14.1	.199	-6	.22	-127	1.12		
1000	.15	-140	8.4	2.64	115	-14.1	.198	-8	.27	-131	1.09		
1500	.22	-142	8.0	2.52	85	-13.7	.206	-12	.34	-143	0.98		
2000	.30	-156	7.4	2.36	55	-13.3	.216	-16	.43	-158	0.85		
2500	.37	-170	6.7	2.16	33	-12.9	.227	-18	.48	-166	0.75		
3000	.41	170	5.6	1.91	8	-12.7	.232	-23	.51	-177	0.70		
3500	.45	149	4.5	1.68	-16	-12.1	.249	-31	.55	173	0.63		
4000	.46	124	3.3	1.45	-40	-11.7	.259	-39	.56	162	0.66		

Typical Performance, $T_A = 25^\circ\text{C}$

(unless otherwise noted)

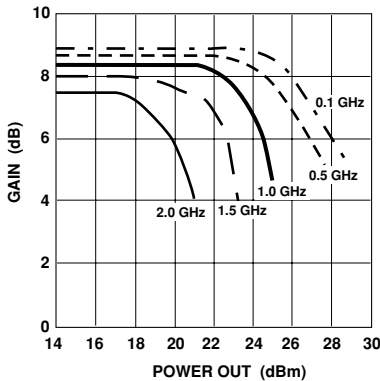

Figure 1. Typical Gain vs. Power Out, $T_A = 25^\circ\text{C}$, $I_d = 165\text{ mA}$.

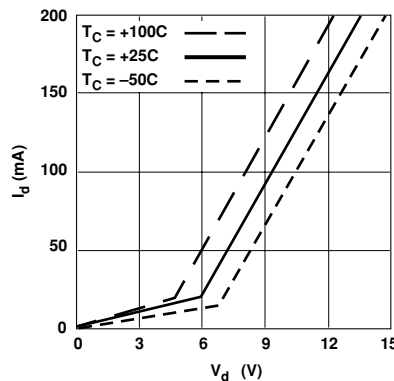

Figure 2. Device Current vs. Voltage.

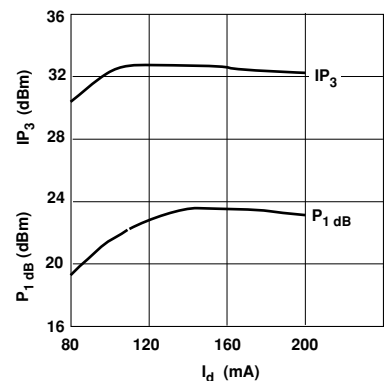

Figure 3. Output Power at 1 dB Gain Compression, Third Order Intercept vs. Current, $f = 1.0\text{ GHz}$.

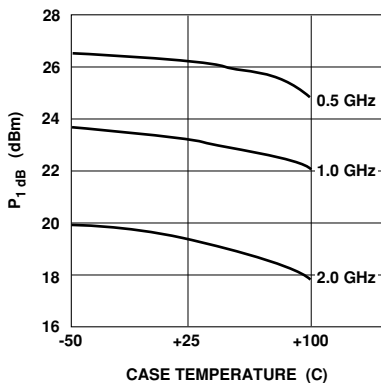

Figure 4. Output Power @ 1 dB Gain Compression vs. Temperature, $I_d = 165\text{ mA}$.

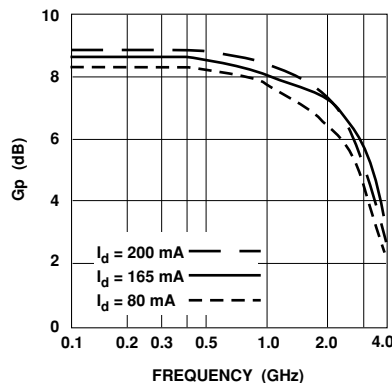

Figure 5. Gain vs. Frequency.

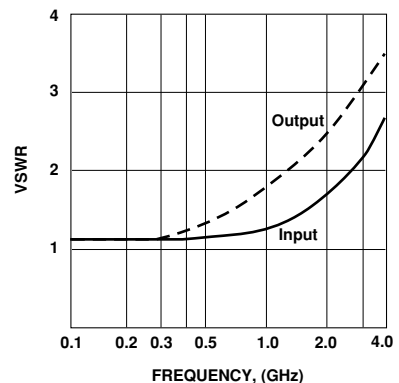

Figure 6. VSWR vs. Frequency, $I_d = 165\text{ mA}$.

