

## Data Sheet

### Description

The MSA-1120 is a high performance silicon bipolar Monolithic Microwave Integrated Circuit (MMIC) housed in a hermetic BeO disk package for good thermal characteristics. This MMIC is designed for high dynamic range in either 50 or 75  $\Omega$  systems by combining low noise figure with high  $IP_3$ . Typical applications include narrow and broadband linear amplifiers in industrial and military systems.

The MSA-series is fabricated using Avago's 10 GHz  $f_T$ , 25 GHz  $f_{MAX}$  silicon bipolar MMIC process which uses nitride self-alignment, ion implantation, and gold metallization to achieve excellent performance, uniformity and reliability. The use of an external bias resistor for temperature and current stability also allows bias flexibility.

### Features

- High Dynamic Range Cascadable 50 $\Omega$  or 75 $\Omega$  Gain Block
- 3 dB Bandwidth: 50 MHz to 1.6 GHz
- 17.5 dBm Typical P1 dB at 0.5 GHz
- 12 dB Typical 50  $\Omega$  Gain at 0.5 GHz
- 3.5 dB Typical Noise Figure at 0.5 GHz
- Hermetic Metal/Beryllia Microstrip Package

### 200 mil BeO Package

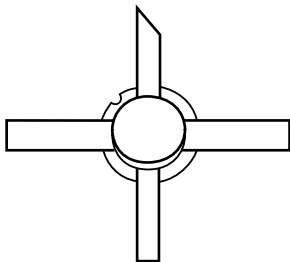

### Typical Biasing Configuration

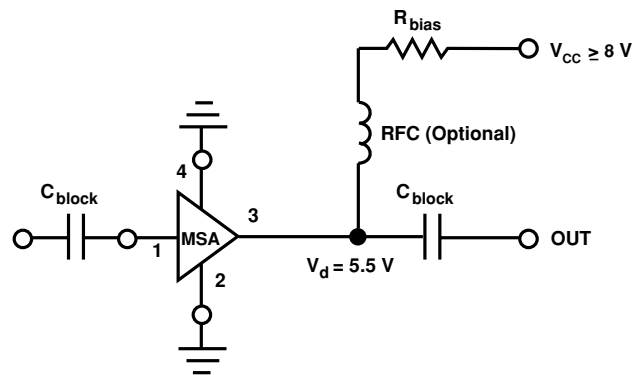

## MSA-1120 Absolute Maximum Ratings

Parameter	Absolute Maximum <sup>[1]</sup>
Device Current	100 mA
Power Dissipation <sup>[2,3]</sup>	650 mW
RF Input Power	+13 dBm
Junction Temperature	200°C
Storage Temperature	-65 to 200°C

Thermal Resistance<sup>[2,4]</sup>:

$$\theta_{jc} = 60^{\circ}\text{C}/\text{W}$$

Notes:

1. Permanent damage may occur if any of these limits are exceeded.
2.  $T_{\text{CASE}} = 25^{\circ}\text{C}$ .
3. Derate at  $16.7 \text{ mW}/^{\circ}\text{C}$  for  $T_{\text{C}} > 161^{\circ}\text{C}$ .
4. The small spot size of this technique results in a higher, though more accurate determination of  $\theta_{jc}$  than do alternate methods.

## Electrical Specifications<sup>[1]</sup>, $T_{\text{A}} = 25^{\circ}\text{C}$

Symbol	Parameters and Test Conditions: $I_{\text{d}} = 60 \text{ mA}$ , $Z_0 = 50 \Omega$	Units	Min.	Typ.	Max.
$G_{\text{p}}$	Power Gain ( $ S_{21} ^2$ ) $f = 0.1 \text{ GHz}$	dB	11.5	12.5	13.5
$\Delta G_{\text{p}}$	Gain Flatness $f = 0.1 \text{ to } 1.0 \text{ GHz}$	dB		$\pm 0.7$	$\pm 1.0$
$f_{3 \text{ dB}}$	3 dB Bandwidth <sup>[2]</sup>	GHz		1.6	
VSWR	Input VSWR $f = 0.1 \text{ to } 1.5 \text{ GHz}$			1.7:1	
	Output VSWR $f = 0.1 \text{ to } 1.5 \text{ GHz}$			1.9:1	
NF	50 $\Omega$ Noise Figure $f = 0.5 \text{ GHz}$	dB		3.5	4.5
$P_{1 \text{ dB}}$	Output Power at 1 dB Gain Compression $f = 0.5 \text{ GHz}$	dBm	16.0	17.5	
$IP_3$	Third Order Intercept Point $f = 0.5 \text{ GHz}$	dBm		30.0	
$t_{\text{D}}$	Group Delay $f = 0.5 \text{ GHz}$	psec		200	
$V_{\text{d}}$	Device Voltage	V	4.5	5.5	6.5
$dV/dT$	Device Voltage Temperature Coefficient	$\text{mV}/^{\circ}\text{C}$		-8.0	

Notes:

1. The recommended operating current range for this device is 40 to 75 mA. Typical performance as a function of current is on the following page.
2. Referenced from 50 MHz gain (GP).

**MSA-1120 Typical Scattering Parameters** ( $Z_0 = 50 \Omega$ ,  $T_A = 25^\circ\text{C}$ ,  $I_d = 60 \text{ mA}$ )

Freq. GHz	$S_{11}$			$S_{21}$			$S_{12}$			$S_{22}$			k
	Mag	Ang	dB	Mag	Ang	dB	Mag	Ang	dB	Mag	Ang	dB	
.0005	.78	-21	19.6	9.53	168	-25.1	.057	50		.79	-21		0.51
.005	.19	-72	13.8	4.91	165	-16.8	.144	11		.19	-72		0.98
.025	.05	-56	12.9	4.44	174	-16.5	.149	3		.06	-75		1.08
.050	.04	-52	12.5	4.23	174	-16.1	.156	2		.04	-79		1.08
.100	.04	-56	12.5	4.22	172	-16.2	.155	1		.04	-78		1.09
.200	.05	-72	12.4	4.19	165	-16.1	.157	1		.06	-91		1.08
.300	.07	-84	12.4	4.15	158	-16.0	.159	2		.09	-101		1.07
.400	.09	-96	12.3	4.10	151	-15.9	.161	2		.11	-109		1.06
.500	.10	-105	12.1	4.04	144	-15.8	.163	3		.13	-117		1.05
.600	.12	-113	12.0	3.98	137	-15.6	.166	3		.16	-124		1.04
.700	.14	-120	11.8	3.89	131	-15.4	.169	2		.18	-130		1.03
.800	.15	-127	11.6	3.80	124	-15.2	.173	2		.20	-136		1.01
.900	.17	-134	11.4	3.71	118	-15.0	.178	1		.22	-142		1.00
1.000	.19	-140	11.1	3.60	112	-14.8	.181	2		.24	-148		0.99
1.500	.25	-167	9.8	3.10	83	-14.0	.200	-3		.31	-174		0.95
2.000	.31	171	8.4	2.64	58	-13.3	.216	-10		.35	163		0.95
2.500	.35	157	7.3	2.31	39	-12.8	.228	-16		.36	148		0.96
3.000	.40	140	6.1	2.02	19	-12.5	.236	-23		.36	134		0.99

**Typical Performance,  $T_A = 25^\circ\text{C}$ ,  $Z_0 = 50 \Omega$**

(unless otherwise noted)

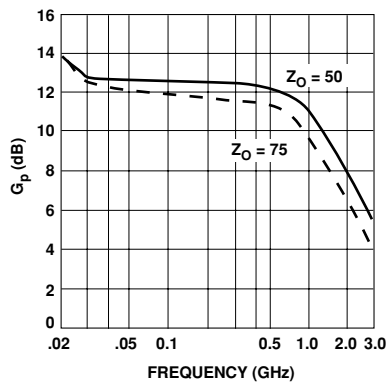

Figure 1. Typical Power Gain vs. Frequency,  $I_d = 60 \text{ mA}$ .

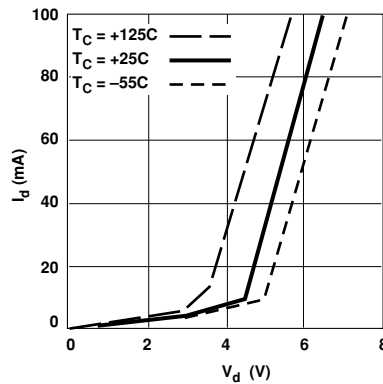

Figure 2. Device Current vs. Voltage.

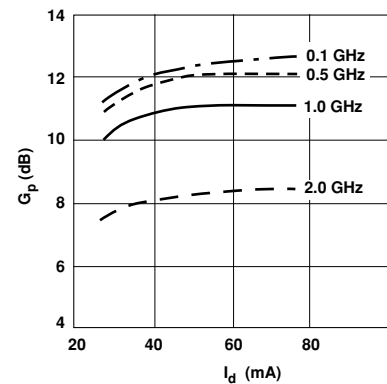

Figure 3. Power Gain vs. Current.

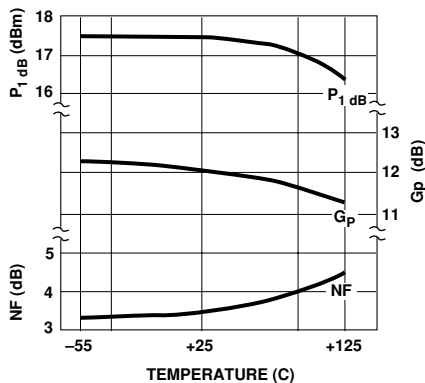

Figure 4. Output Power at 1 dB Gain Compression, Noise Figure and Power Gain vs. Case Temperature,  $f = 0.5 \text{ GHz}$ ,  $I_d = 60 \text{ mA}$ .

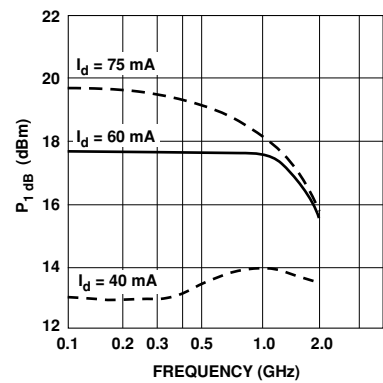

Figure 5. Output Power at 1 dB Gain Compression vs. Frequency.

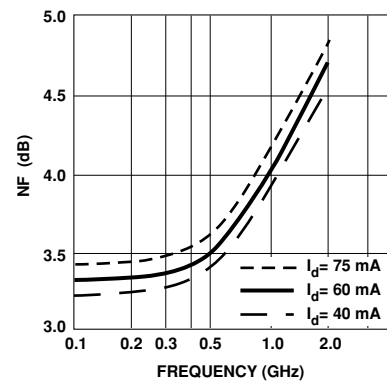
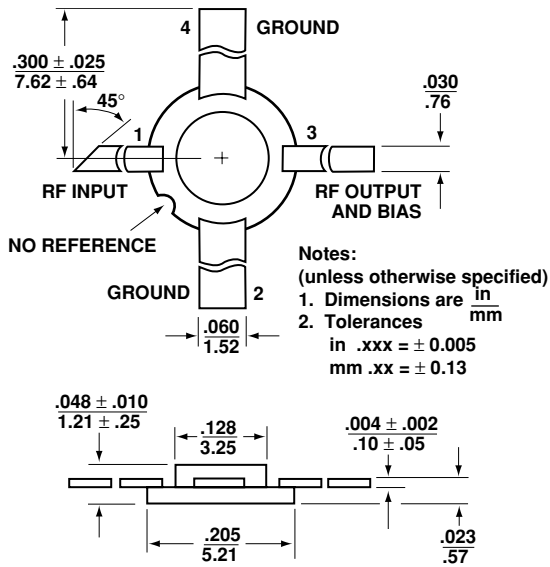

Figure 6. Noise Figure vs. Frequency.

## Ordering Information

Part Numbers	No. of Devices	Comments
MSA-1120	100	Bulk

## 200 mil BeO Package Dimensions



For product information and a complete list of distributors, please go to our web site: [www.avagotech.com](http://www.avagotech.com)

Avago, Avago Technologies, and the A logo are trademarks of Avago Technologies, Limited in the United States and other countries. Data subject to change. Copyright © 2008 Avago Technologies, Limited. All rights reserved. Obsoletes 5989-2748EN AV02-1234EN May 14, 2008

**AVAGO**  
TECHNOLOGIES