

MSA-0636

Cascadable Silicon Bipolar MMIC Amplifiers



Data Sheet

Description

The MSA-0636 is a high performance silicon bipolar Monolithic Microwave Integrated Circuit (MMIC) housed in a cost effective, microstrip package. This MMIC is designed for use as a general purpose 50Ω gain block. Typical applications include narrow and broad band IF and RF amplifiers in commercial and industrial applications.

The MSA-series is fabricated using Avago's 10 GHz f_T , 25 GHz f_{MAX} , silicon bipolar MMIC process which uses nitride self-alignment, ion implantation, and gold metallization to achieve excellent performance, uniformity and reliability. The use of an external bias resistor for temperature and current stability also allows bias flexibility.

Features

- Cascadable 50Ω Gain Block
- Low Operating Voltage:
3.5 V Typical V_d
- 3 dB Bandwidth:
DC to 0.9 GHz
- High Gain:
19.0 dB Typical at 0.5 GHz
- Low Noise Figure:
2.8 dB Typical at 0.5 GHz
- Cost Effective Ceramic Microstrip Package

36 micro-X Package

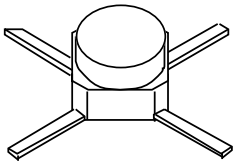

Typical Biasing Configuration

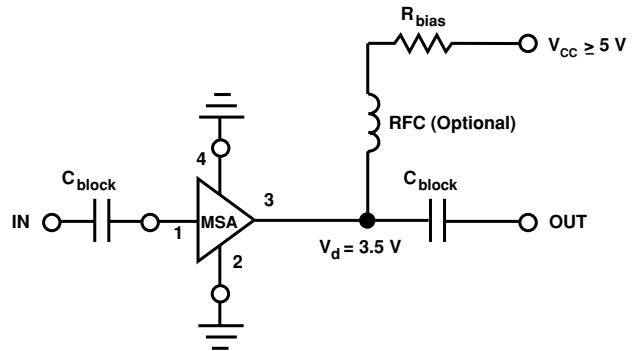

MSA-0636 Absolute Maximum Ratings

Parameter	Absolute Maximum ^[1]
Device Current	50 mA
Power Dissipation ^[2,3]	200 mW
RF Input Power	+13 dBm
Junction Temperature	150°C
Storage Temperature ^[4]	-65 to 150°C

Thermal Resistance^{[2,5]:}

$$\theta_{jc} = 155^{\circ}\text{C}/\text{W}$$

Notes:

1. Permanent damage may occur if any of these limits are exceeded.
2. $T_{\text{CASE}} = 25^{\circ}\text{C}$.
3. Derate at $6.5 \text{ mW}/^{\circ}\text{C}$ for $T_{\text{C}} > 169^{\circ}\text{C}$.
4. Storage above $+150^{\circ}\text{C}$ may tarnish the leads of this package making it difficult to solder into a circuit.
5. The small spot size of this technique results in a higher, though more accurate determination of θ_{jc} than do alternate methods.

Electrical Specifications^[1], $T_{\text{A}} = 25^{\circ}\text{C}$

Symbol	Parameters and Test Conditions: $I_{\text{d}} = 16 \text{ mA}$, $Z_{\text{o}} = 50 \Omega$	Units	Min.	Typ.	Max.
GP	Power Gain ($ S_{21} ^2$) $f = 0.1 \text{ GHz}$	dB	19.0	20.5	22.0
ΔGP	Gain Flatness $f = 0.1 \text{ to } 0.5 \text{ GHz}$	dB		± 0.7	± 1.0
$f_3 \text{ dB}$	3 dB Bandwidth	GHz		0.9	
VSWR	Input VSWR $f = 0.1 \text{ to } 1.5 \text{ GHz}$			1.4:1	
	Output VSWR $f = 0.1 \text{ to } 1.5 \text{ GHz}$			1.3:1	
NF	50 Ω Noise Figure $f = 0.5 \text{ GHz}$	dB		2.8	4.0
$P_{1 \text{ dB}}$	Output Power at 1 dB Gain Compression $f = 0.5 \text{ GHz}$	dBm		2.0	
IP_3	Third Order Intercept Point $f = 0.5 \text{ GHz}$	dBm		14.5	
t_{D}	Group Delay $f = 0.5 \text{ GHz}$	psec		200	
V_{d}	Device Voltage	V	3.1	3.5	3.9
dV/dT	Device Voltage Temperature Coefficient	$\text{mV}/^{\circ}\text{C}$		-8.0	

Note:

1. The recommended operating current range for this device is 12 to 30 mA. Typical performance as a function of current is on the following page.

Ordering Information

Part Numbers	No. of Devices	Comments
MSA-0636-BLKG	100	Bulk
MSA-0636-TR1G	1000	7" Reel

MSA-0636 Typical Scattering Parameters ($Z_0 = 50 \Omega$, $T_A = 25^\circ\text{C}$, $I_d = 16 \text{ mA}$)

Freq. GHz	S_{11}		S_{21}			S_{12}			S_{22}		k
	Mag	Ang	dB	Mag	Ang	dB	Mag	Ang	Mag	Ang	
0.1	.03	-178	20.5	10.59	171	-23.4	.068	5	.04	-44	1.05
0.2	.02	-177	20.3	10.31	161	-22.9	.071	8	.05	-68	1.04
0.3	.02	-164	20.0	9.96	152	-22.4	.076	14	.06	-87	1.04
0.4	.02	-116	19.6	9.55	144	-22.0	.079	19	.07	-104	1.03
0.5	.02	-100	19.2	9.08	136	-21.8	.081	21	.09	-114	1.04
0.6	.04	-89	18.7	8.59	128	-21.3	.086	24	.09	-123	1.04
0.8	.07	-96	17.7	7.66	115	-20.2	.098	29	.10	-140	1.03
1.0	.10	-108	16.6	6.79	103	-19.4	.107	31	.11	-156	1.02
1.5	.17	-134	14.2	5.13	79	-17.2	.138	30	.12	172	1.03
2.0	.24	-160	12.1	4.01	60	-15.8	.163	26	.12	148	1.04
2.5	.31	-178	10.3	3.26	48	-15.1	.175	27	.12	140	1.08
3.0	.37	166	8.7	2.72	34	-14.4	.190	24	.11	135	1.10
3.5	.42	151	7.4	2.33	21	-13.9	.203	19	.10	144	1.11
4.0	.46	139	6.2	2.04	9	-13.3	.216	16	.08	167	1.11
4.5	.48	126	5.1	1.81	-3	-12.8	.229	12	.08	-173	1.11
5.0	.52	110	4.2	1.62	-15	-12.2	.245	8	.09	-173	1.09

Typical Performance, $T_A = 25^\circ\text{C}$

(unless otherwise noted)

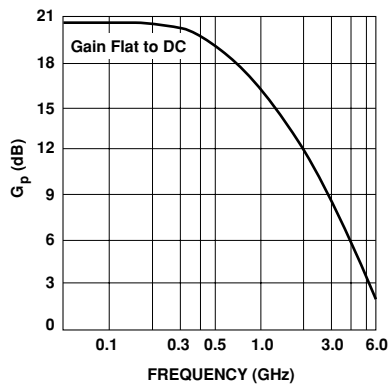
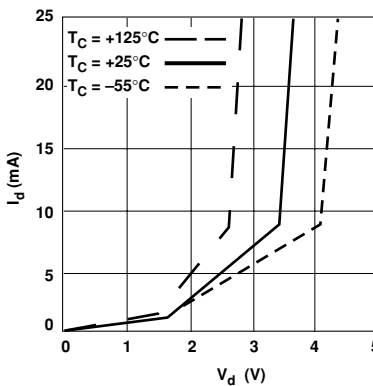
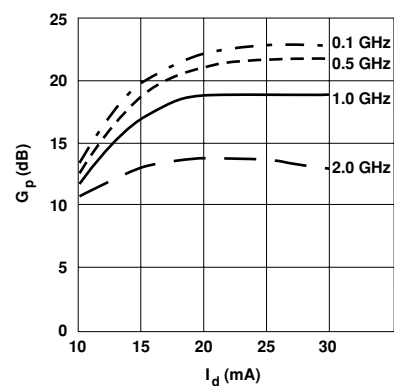
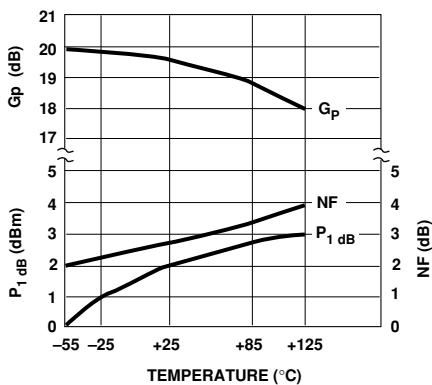
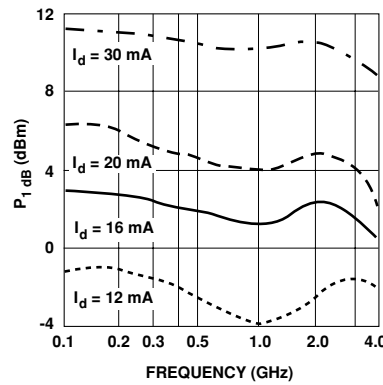
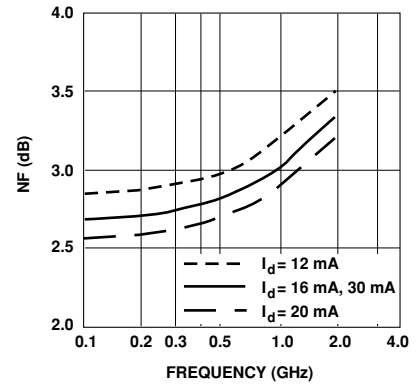
Figure 1. Typical Power Gain vs. Frequency, $I_d = 16 \text{ mA}$.

Figure 2. Device Current vs. Voltage.

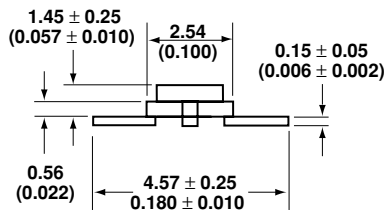
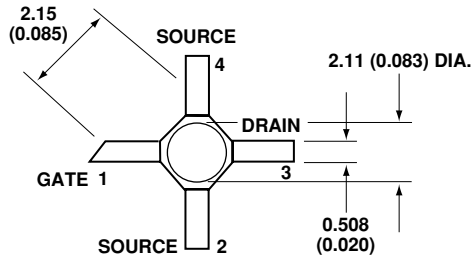
Figure 3. Power Gain vs. Current.

Figure 4. Output Power at 1 dB Gain Compression, NF and Power Gain vs. Case Temperature, $f = 0.5 \text{ GHz}$, $I_d = 16 \text{ mA}$.

Figure 5. Output Power at 1 dB Gain Compression vs. Frequency.

Figure 6. Noise Figure vs. Frequency.

36 micro-X Package Dimensions



Notes:

1. Dimensions are in millimeters (inches)
2. Tolerances: in .xxx = ± 0.005
mm .xx = ± 0.13

For product information and a complete list of distributors, please go to our web site: www.avagotech.com

Avago, Avago Technologies, and the A logo are trademarks of Avago Technologies, Limited in the United States and other countries. Data subject to change. Copyright © 2007 Avago Technologies, Limited. All rights reserved. Obsoletes 5989-2743EN AV02-0304EN - April 12, 2007

AVAGO
TECHNOLOGIES