

**RoHS Compliant & Pb-Free Product**

Typical Applications

- Narrow and Broadband Commercial and Military Radio Designs
- Linear and Saturated Amplifiers
- Gain Stage or Driver Amplifiers for MWRadio/Optical Designs (PTP/PMP/LMDS/UNII/VSAT/WLAN/Cellular/DWDM)

Product Description

The NBB-502 cascable broadband InGaP/GaAs MMIC amplifier is a low-cost, high-performance solution for general purpose RF and microwave amplification needs. This 50Ω gain block is based on a reliable HBT proprietary MMIC design, providing unsurpassed performance for small-signal applications. Designed with an external bias resistor, the NBB-502 provides flexibility and stability. The NBB-502 is packaged in a low-cost, surface-mount ceramic package, providing ease of assembly for high-volume tape-and-reel requirements. It is available in either 1,000 or 3,000 piece-per-reel quantities.

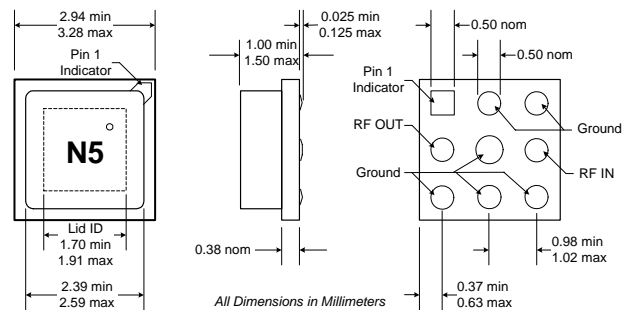

- Notes:
1. Solder pads are coplanar to within ±0.025 mm.
  2. Lid will be centered relative to frontside metallization with a tolerance of ±0.13 mm.
  3. Mark to include two characters and dot to reference pin 1.

Optimum Technology Matching® Applied

- |   |                                   |                                       |
|---|-----------------------------------|---------------------------------------|
| <input type="checkbox"/> Si BJT               | <input type="checkbox"/> GaAs HBT | <input type="checkbox"/> GaAs MESFET  |
| <input type="checkbox"/> Si Bi-CMOS           | <input type="checkbox"/> SiGe HBT | <input type="checkbox"/> Si CMOS      |
| <input checked="" type="checkbox"/> InGaP/HBT | <input type="checkbox"/> GaN HEMT | <input type="checkbox"/> SiGe Bi-CMOS |

Package Style: MPGA, Bowtie, 3x3, Ceramic

Features

- Reliable, Low-Cost HBT Design
- 19.0dB Gain, +13.0dBm P1dB @ 2GHz
- High P1dB of +14.0dBm @ 6.0GHz
- Single Power Supply Operation
- 50Ω I/O Matched for High Freq. Use

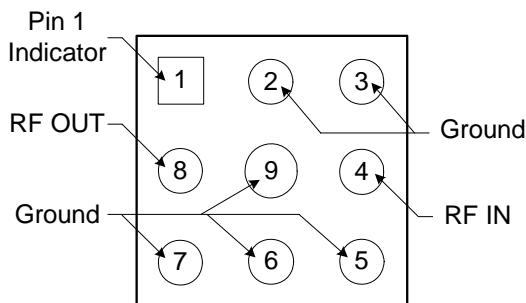

Functional Block Diagram

Ordering Information

NBB-502	Cascadable Broadband GaAs MMIC Amplifier DC to 4GHz
NBB-502-T1	Tape & Reel, 1000 Pieces
NBB-502-E	Fully Assembled Evaluation Board
NBB-X-K1	Extended Frequency InGaP Amp Designer's Tool Kit
RF Micro Devices, Inc.	Tel (336) 664 1233
7628 Thorndike Road	Fax (336) 664 0454
Greensboro, NC 27409, USA	http://www.rfmd.com

# NBB-502

## Absolute Maximum Ratings

Parameter	Rating	Unit
RF Input Power	+20	dBm
Power Dissipation	300	mW
Device Current	70	mA
Channel Temperature	200	°C
Operating Temperature	-45 to +85	°C
Storage Temperature	-65 to +150	°C

Exceeding any one or a combination of these limits may cause permanent damage.



**Caution!** ESD sensitive device.

RF Micro Devices believes the furnished information is correct and accurate at the time of this printing. RoHS marking based on EUDirective2002/95/EC (at time of this printing). However, RF Micro Devices reserves the right to make changes to its products without notice. RF Micro Devices does not assume responsibility for the use of the described product(s).

Parameter	Specification			Unit	Condition
	Min.	Typ.	Max.		
<b>Overall</b>					$V_D=+3.9V, I_{CC}=35mA, Z_0=50\Omega, T_A=+25^\circ C$
Small Signal Power Gain, S21	19.0	20.5		dB	f=0.1GHz to 1.0GHz
		19.0		dB	f=1.0GHz to 2.0GHz
	16.0	17.0		dB	f=2.0GHz to 4.0GHz
Gain Flatness, $G_F$		$\pm 0.8$		dB	f=1.0GHz to 3.0GHz
Input and Output VSWR		1.55:1			f=0.1GHz to 4.0GHz
		1.50:1			f=4.0GHz to 6.0GHz
		1.55:1			f=6.0GHz to 10.0GHz
Bandwidth, BW		4.2		GHz	BW3 (3dB)
Output Power @ -1dB Compression, P1dB		13.0		dBm	f=2.0GHz
		14.0		dBm	f=6.0GHz
Noise Figure, NF		4.0		dB	f=3.0GHz
Third Order Intercept, IP3		+23.0		dBm	f=2.0GHz
Reverse Isolation, S12		-17.0		dB	f=0.1GHz to 10.0GHz
Device Voltage, $V_D$	3.6	3.9	4.2	V	
Gain Temperature Coefficient, $\delta G_T/\delta T$		-0.0015		dB/°C	
<b>MTTF versus Temperature @ <math>I_{CC}=35mA</math></b>					
Case Temperature		85		°C	
Junction Temperature		109.4		°C	
MTTF		>1,000,000		hours	
<b>Thermal Resistance</b>					
$\theta_{JC}$		179		°C/W	$\frac{J_T - T_{CASE}}{V_D \cdot I_{CC}} = \theta_{JC} (^\circ C/Watt)$

Pin	Function	Description	Interface Schematic
1	<b>GND</b>	Ground connection. For best performance, keep traces physically short and connect immediately to ground plane.	
2	<b>GND</b>	Same as pin 1.	
3	<b>GND</b>	Same as pin 1.	
4	<b>RF IN</b>	RF input pin. This pin is NOT internally DC blocked. A DC blocking capacitor, suitable for the frequency of operation, should be used in most applications. DC coupling of the input is not allowed, because this will override the internal feedback loop and cause temperature instability.	
5	<b>GND</b>	Same as pin 1.	
6	<b>GND</b>	Same as pin 1.	
7	<b>GND</b>	Same as pin 1.	
8	<b>RF OUT</b>	<p>RF output and bias pin. Biasing is accomplished with an external series resistor and choke inductor to <math>V_{CC}</math>. The resistor is selected to set the DC current into this pin to a desired level. The resistor value is determined by the following equation:</p> $R = \frac{(V_{CC} - V_{DEVICE})}{I_{CC}}$ <p>Care should also be taken in the resistor selection to ensure that the current into the part never exceeds maximum datasheet operating current over the planned operating temperature. This means that a resistor between the supply and this pin is always required, even if a supply near 5.0V is available, to provide DC feedback to prevent thermal runaway. Alternatively, a constant current supply circuit may be implemented. Because DC is present on this pin, a DC blocking capacitor, suitable for the frequency of operation, should be used in most applications. The supply side of the bias network should also be well bypassed.</p>	
9	<b>GND</b>	Same as pin 1.	

## Typical Bias Configuration

Application notes related to biasing circuit, device footprint, and thermal considerations are available on request.

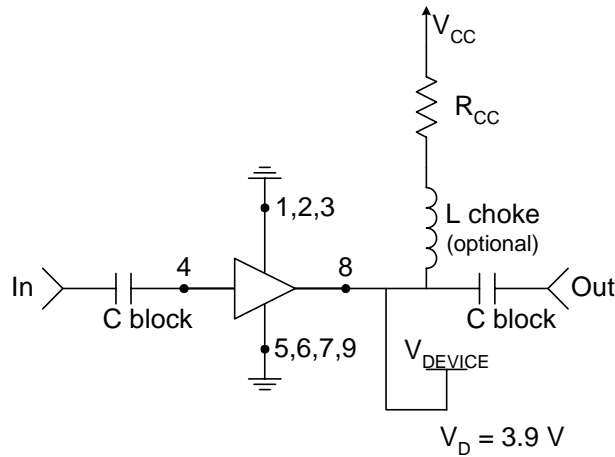

Recommended Bias Resistor Values						
Supply Voltage, $V_{CC}$ (V)	5	8	10	12	15	20
Bias Resistor, $R_{CC}$ ( $\Omega$ )	31	117	174	231	317	460

## Application Notes

### Die Attach

The die attach process mechanically attaches the die to the circuit substrate. In addition, it electrically connects the ground to the trace on which the chip is mounted, and establishes the thermal path by which heat can leave the chip.

### Wire Bonding

Electrical connections to the chip are made through wire bonds. Either wedge or ball bonding methods are acceptable practices for wire bonding.

### Assembly Procedure

Epoxy or eutectic die attach are both acceptable attachment methods. Top and bottom metallization are gold. Conductive silver-filled epoxies are recommended. This procedure involves the use of epoxy to form a joint between the backside gold of the chip and the metallized area of the substrate. A 150°C cure for 1 hour is necessary. Recommended epoxy is Ablebond 84-1LMI from Ablestik.

### Bonding Temperature (Wedge or Ball)

It is recommended that the heater block temperature be set to 160°C ± 10°C.

## Extended Frequency InGaP Amplifier Designer's Tool Kit NBB-X-K1

This tool kit was created to assist in the design-in of the RFMD NBB- and NLB-series InGaP HBT gain block amplifiers. Each tool kit contains the following.

- 5 each NBB-300, NBB-310 and NBB-400 Ceramic Micro-X Amplifiers
- 5 each NLB-300, NLB-310 and NLB-400 Plastic Micro-X Amplifiers
- 2 Broadband Evaluation Boards and High Frequency SMA Connectors
- Broadband Bias Instructions and Specification Summary Index for ease of operation

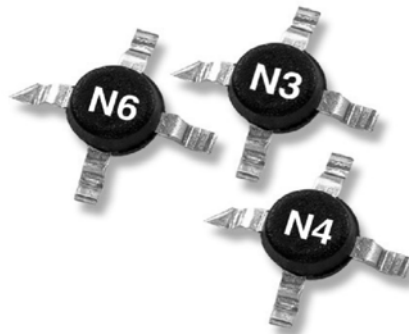
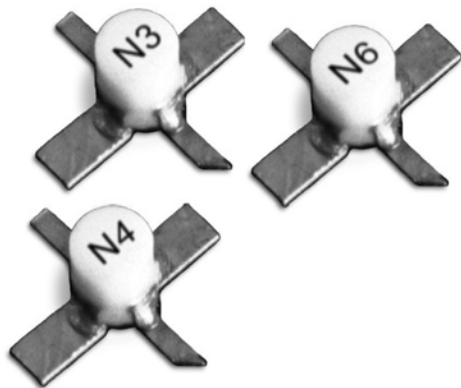

### Tape and Reel Dimensions All Dimensions in Millimeters

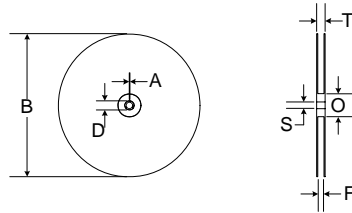

330 mm (13") REEL			Micro-X, MPGA	
	ITEMS	SYMBOL	SIZE (mm)	SIZE (inches)
FLANGE	Diameter	B	330 +0.25/-4.0	13.0 +0.079/-0.158
	Thickness	T	18.4 MAX	0.724 MAX
	Space Between Flange	F	12.4 +2.0	0.488 +0.08
HUB	Outer Diameter	O	102.0 REF	4.0 REF
	Spindle Hole Diameter	S	13.0 +0.5/-0.2	0.512 +0.020/-0.008
	Key Slit Width	A	1.5 MIN	0.059 MIN
	Key Slit Diameter	D	20.2 MIN	0.795 MIN

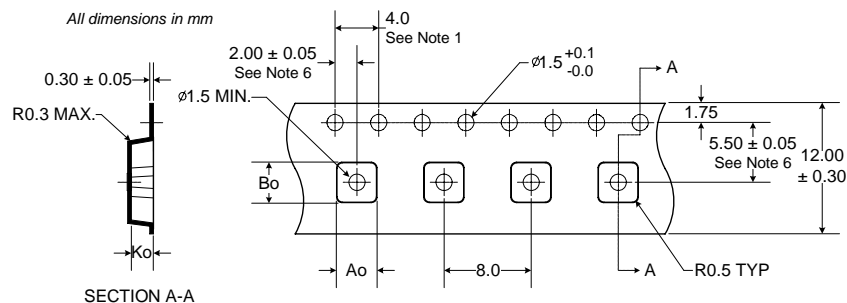
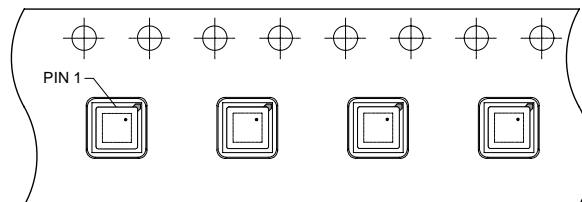

- NOTES:**
- 10 sprocket hole pitch cumulative tolerance ±0.2.
  - Camber not to exceed 1 mm in 100 mm.
  - Material: PS+C
  - Ao and Bo measured on a plane 0.3 mm above the bottom of the pocket.
  - Ko measured from a plane on the inside bottom of the pocket to the surface of the carrier.
  - Pocket position relative to sprocket hole measured as true position of pocket, not pocket hole.

Ao = 3.6 MM  
Bo = 3.6 MM  
Ko = 1.7 MM

Device Voltage versus Amplifier Current

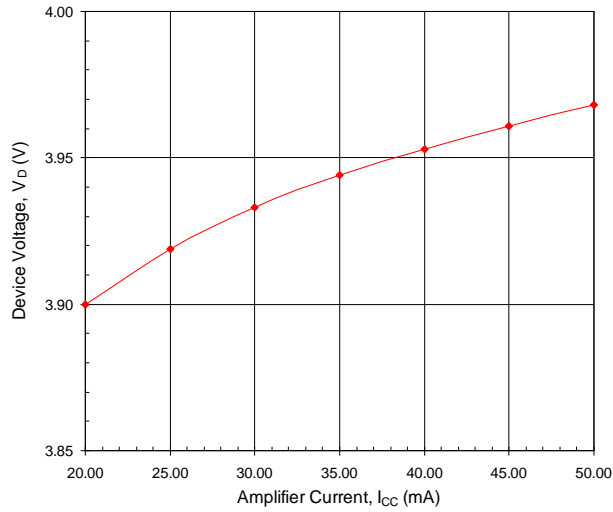

P1dB versus Frequency at 25°C

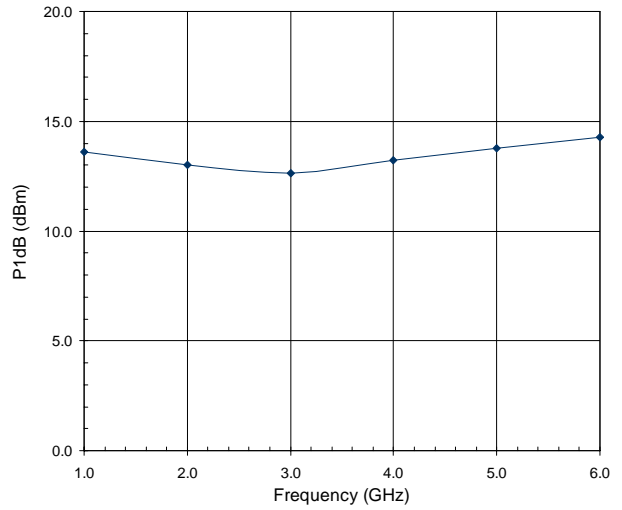

$P_{OUT}/Gain$  versus  $P_{IN}$  at 2 GHz

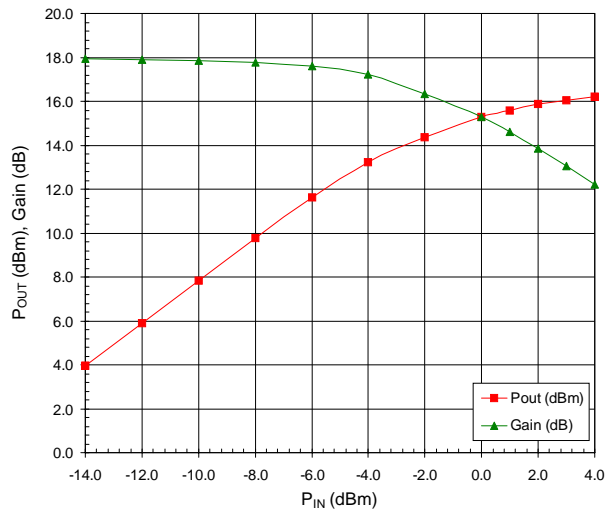

$P_{OUT}/Gain$  versus  $P_{IN}$  at 6 GHz

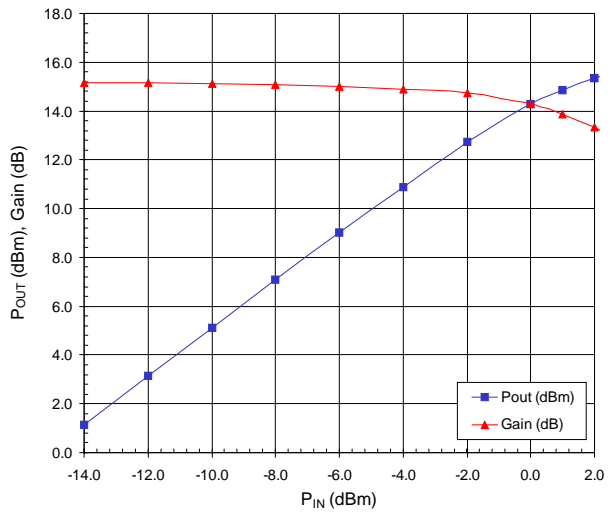

Third Order Intercept versus Frequency at 25°C

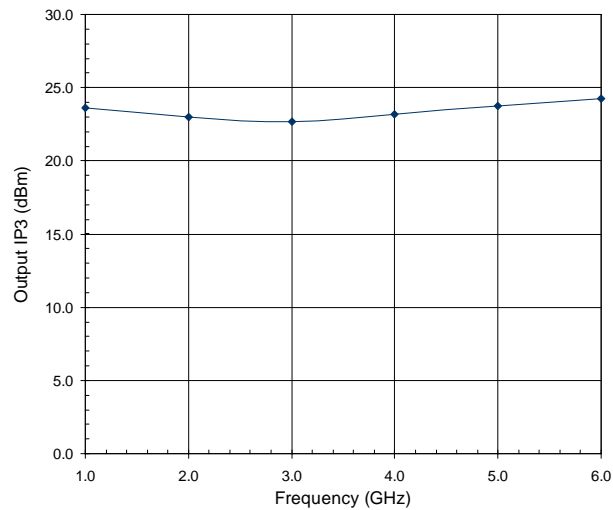

# NBB-502

Note: The s-parameter gain results shown below include device performance as well as evaluation board and connector loss variations. The insertion losses of the evaluation board and connectors are as follows:

- 1 GHz to 4 GHz=-0.06 dB
- 5 GHz to 9 GHz=-0.22 dB
- 10 GHz to 14 GHz=-0.50 dB
- 15 GHz to 20 GHz=-1.08 dB

**S11 versus Frequency at +25°C**

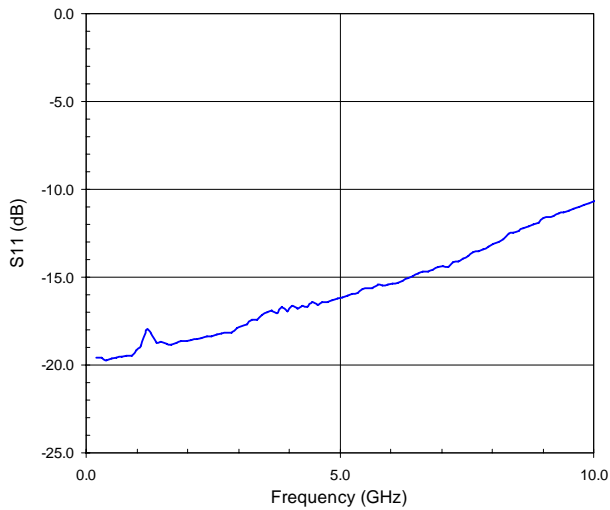

**S12 versus Frequency at +25°C**

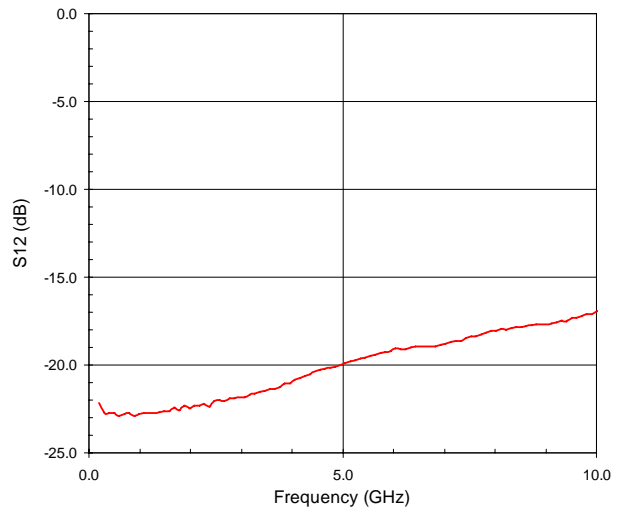

**S21 versus Frequency at +25°C**

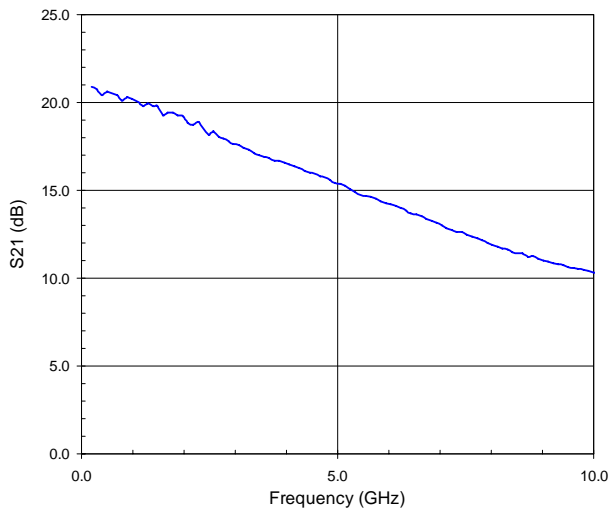

**S22 versus Frequency at +25°C**

