



### Product Description

RFMD's SGA-1263(Z) is a Silicon Germanium HBT Heterostructure Bipolar Transistor (SiGe HBT) amplifier that offers excellent isolation and flat gain response for application to 4GHz. This RFIC is a 2-stage design that provides high isolation of up to 40dB at 2GHz and is fabricated using the latest SiGe HBT 50GHz  $F_T$  process, featuring one-micron emitters with  $V_{CE0} > 7V$ . These unconditionally stable amplifiers have less than 1dB gain drift over 125°C operating range (-40°C to +85°C) and are ideal for use as buffer amplifiers in oscillator applications covering cellular, ISM, and narrowband PCS bands.

**Optimum Technology Matching® Applied**

- GaAs HBT
- GaAs MESFET
- InGaP HBT
- SiGe BiCMOS
- Si BiCMOS
- SiGe HBT
- GaAs pHEMT
- Si CMOS
- Si BJT
- GaN HEMT
- InP HBT
- RF MEMS
- LDMOS

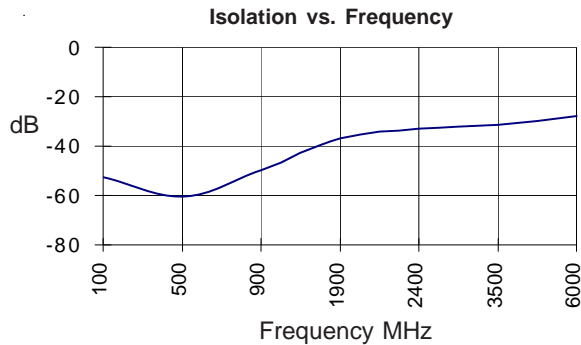

### Features

- DC to 400MHz Operation
- Single Supply Voltage
- Excellent Isolation, >50dB at 900MHz
- 50W In/Out, Broadband Match for Operation from DC-4GHz
- Unconditionally Stable

### Applications

- Buffer Amplifier for Oscillator Applications
- Broadband Gain Blocks
- IF Amp

Parameter	Specification			Unit	Condition
	Min.	Typ.	Max.		
Small Signal Gain	15	17	19	dB	850MHz
	12	15	17	dB	1950MHz
Output Power at 1dB Compression	-13.0	-9.5		dBm	1950MHz
Output Third Order Intercept Point	-1.5	1.0		dBm	1950MHz
Determined by Return Loss (<-10dB)					
Input Return Loss	9.5	11.2		dB	1950MHz
Output Return Loss	7	8		dB	1950MHz
Noise Figure		2.5	4.0	dB	1950MHz
Device Voltage	2.5	2.8	3.1	V	
Thermal Resistance		255		°C/W	

Test Conditions:  $V_S = 5V$ ,  $I_D = 8mA$  Typ., OIP3 Tone Spacing = 1MHz,  $P_{OUT}$  per tone = -20dBm,  $R_{BIAS} = 270\Omega$ ,  $T_L = 25^\circ C$ ,  $Z_S = Z_L = 50\Omega$

## Absolute Maximum Ratings

Parameter	Rating	Unit
Max Device Current (ID)	20	mA
Max Device Voltage (VD)	5	V
Max RF Input Power	-12	dBm
Max Junction Temperature (TJ)	+150	°C
Operating Temperature Range (TL)	-40 to +85	°C
Max Storage Temperature	+150	°C

Operation of this device beyond any one of these limits may cause permanent damage. For reliable continuous operation, the device voltage and current must not exceed the maximum operating values specified in the table on page one.

Bias Conditions should also satisfy the following expression:

$$I_D V_D < (T_J - T_L) / R_{TH}, j-l$$



**Caution!** ESD sensitive device.

Exceeding any one or a combination of the Absolute Maximum Rating conditions may cause permanent damage to the device. Extended application of Absolute Maximum Rating conditions to the device may reduce device reliability. Specified typical performance or functional operation of the device under Absolute Maximum Rating conditions is not implied.

RoHS status based on EU Directive 2002/95/EC (at time of this document revision).

The information in this publication is believed to be accurate and reliable. However, no responsibility is assumed by RF Micro Devices, Inc. ("RFMD") for its use, nor for any infringement of patents, or other rights of third parties, resulting from its use. No license is granted by implication or otherwise under any patent or patent rights of RFMD. RFMD reserves the right to change component circuitry, recommended application circuitry and specifications at any time without prior notice.

Parameter	Specification			Unit	Condition
	Min.	Typ.	Max.		
Bandwidth					T=25 °C
Frequency Range	DC		4000	MHz	
Device Bias					T=25 °C
Operating Voltage		2.8		V	
Operating Current		8		mA	
500MHz					T=25 °C
Gain		16.0		dB	
Noise Figure		2.7		dB	
Output IP3		4.0		dBm	
Output P1dB		-6.9		dBm	
Input Return Loss		8.5		dB	
Isolation		61.6		dB	
850MHz					T=25 °C
Gain		15.7		dB	
Noise Figure		2.7		dB	
Output IP3		2.6		dBm	
Output P1dB		-7.8		dBm	
Input Return Loss		8.9		dB	
Isolation		48.4		dB	
1950MHz					T=25 °C
Gain		14.7		dB	
Noise Figure		3.0		dB	
Output IP3		2.8		dBm	
Output P1dB		-7.4		dBm	
Input Return Loss		8.8		dB	
Isolation		35.6		dB	
2400MHz					T=25 °C
Gain		14.2		dB	
Noise Figure		2.8		dB	
Output IP3		0.2		dBm	
Output P1dB		-7.0		dBm	
Input Return Loss		8.4		dB	
Isolation		33.6		dB	

Pin	Function	Description
1	GND	Connection to ground. Use via holes for best performance to reduce lead inductance as close to ground leads as possible.
2	GND	Same as Pin 1.
3	RF IN	RF input pin. This pin requires the use of an external DC blocking capacitor chosen for the frequency of operation.
4	VCC	Supply Connection. This pin should be bypassed with suitable capacitor(s).
5	GND	Same as Pin 1.
6	RF OUT	RF output and bias pin. DC voltage is present on this pin, therefore a DC blocking capacitor is necessary for proper operation.

**Application Schematic for +5V Operation at 900MHz**

**Note: A bias resistor is needed for stability over temperature**

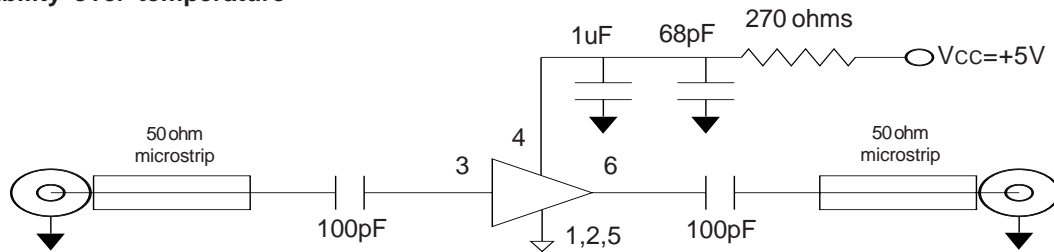

**Application Schematic for +5V Operation at 1900MHz**

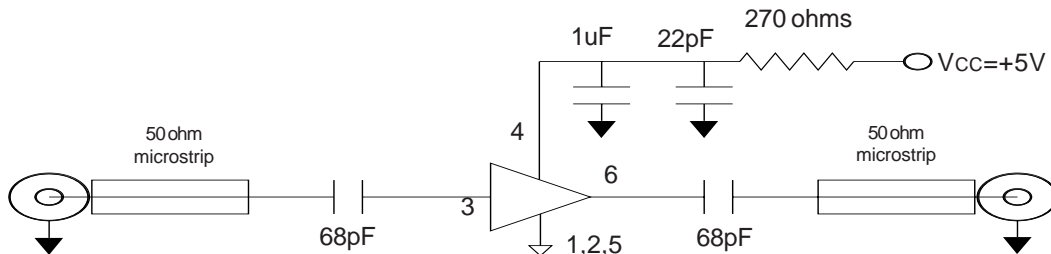

Recommended Bias Resistor Values					
Supply Voltage(Vs)	3.6V	5V	7.5V	9V	12V
Rbias (Ohms)	100	275	588	775	1150

# SGA-1263(Z)



rfmd.com

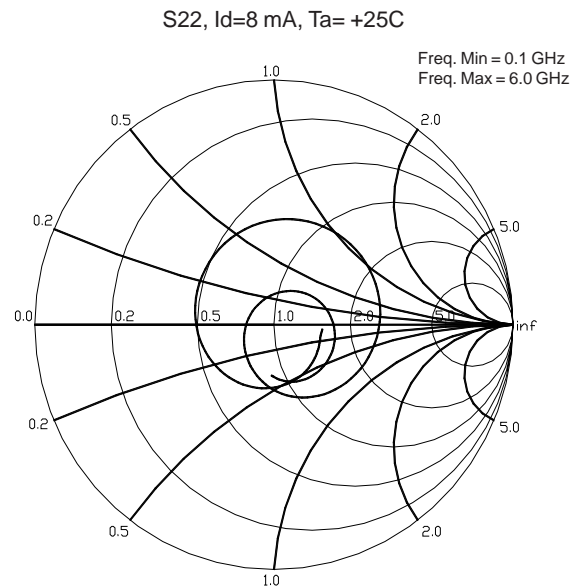
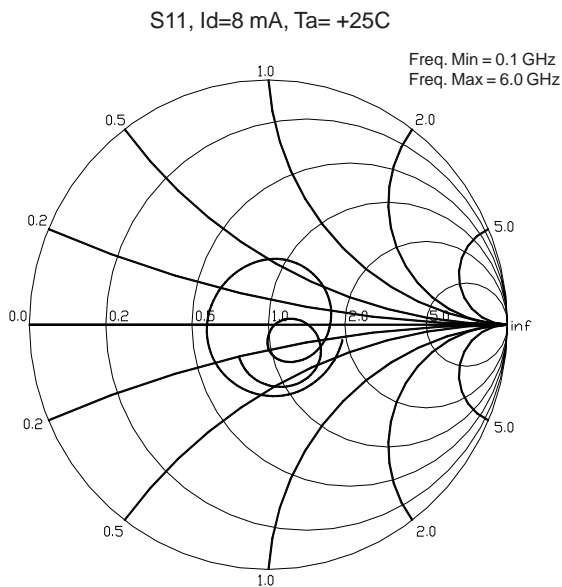
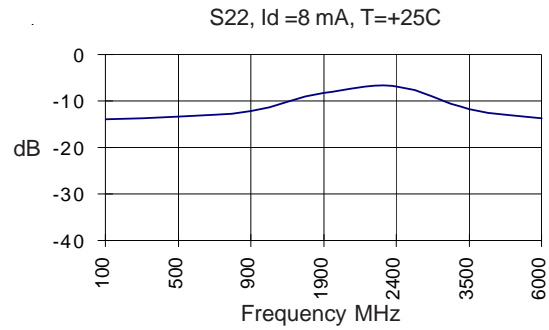
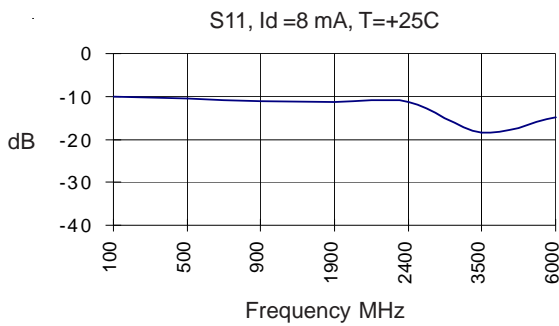
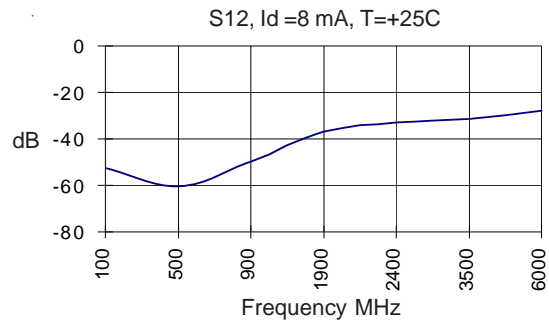
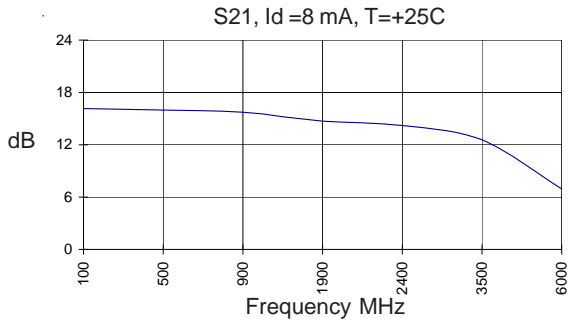

**Package Dimensions**

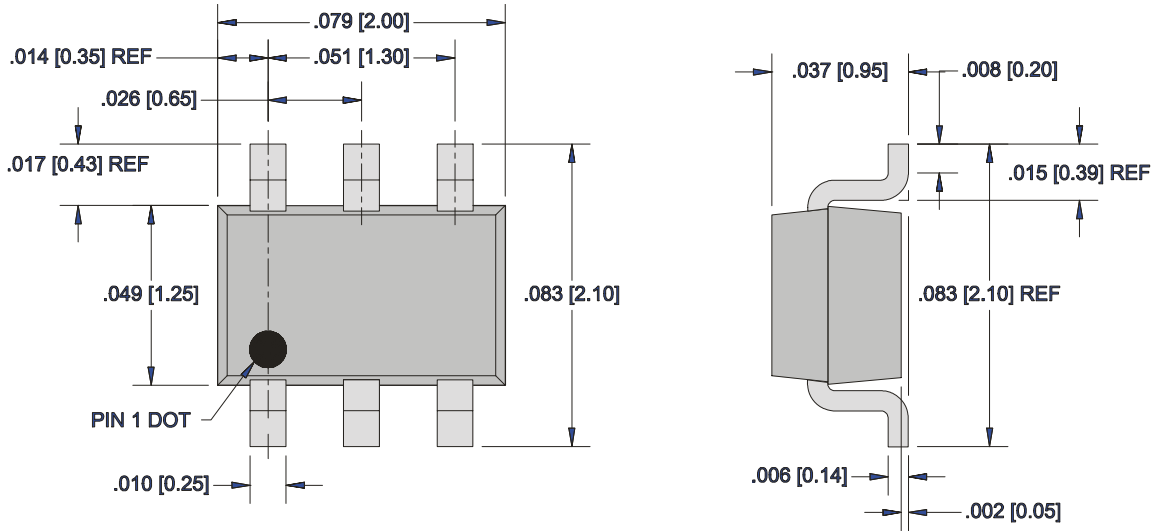

**Pad Layout**

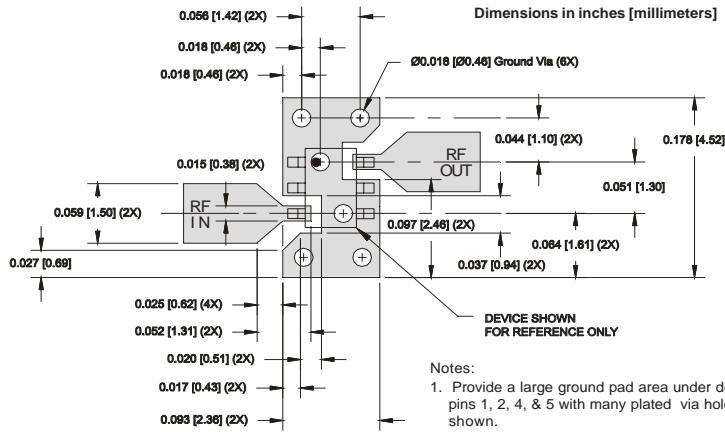

- Notes:
1. Provide a large ground pad area under device pins 1, 2, 4, & 5 with many plated via holes as shown.
  2. Dimensions given for 50 Ohm RF I/O lines are for 31 mil thick Getek. Scale accordingly for different board thicknesses and dielectric constants.
  3. We recommend 1 or 2 ounce copper. Measurements for this data sheet were made on a 31 mil thick Getek with 1 ounce copper on both sides.

### Part Identification Marking

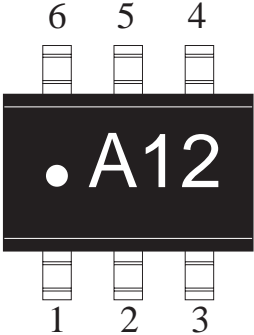

RoHS Compliant part will be indicated with a "12Z" part marking.

### Alternate Marking with Trace Code Only

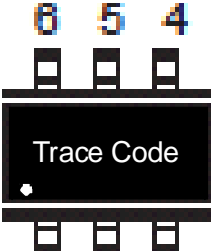

### Ordering Information

Part Number	Description	Reel Size	Devices/Reel
SGA-1263	Tin-Lead	7"	3000
SGA-1263Z	Lead Free, RoHS Compliant	7"	3000