



**Features**

- Low Noise and High Intercept Point
- Adjustable Bias Current
- Power Down Control
- Low Insertion Loss Bypass Feature
- 1.8V to 5V Operation (See Note: Page 2)
- 1.5GHz to 3.8GHz Operation

**Applications**

- WLAN LNA with Bypass Feature
- CDMA PCS LNA with Bypass Feature
- MMDS LNA with Bypass Feature
- General Purpose Amplification
- Commercial and Consumer Systems

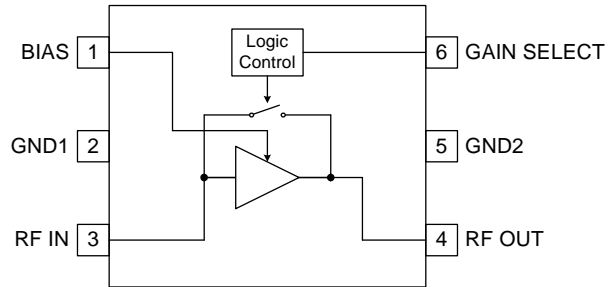

Functional Block Diagram

**Product Description**

The RF2370 is a switchable low noise amplifier with a very high dynamic range designed for digital cellular and WLAN applications. The device functions as an outstanding front end low noise amplifier. The bias current may be set externally. The IC is featured in a standard SOT 6-lead plastic package.

**Ordering Information**

|               |   |
|---------------|---|
| RF2370        | 3V Low Noise Amplifier  |
| RF2370PCK-410 | Fully assembled evaluation board tuned for 1900 to 4000 MHz and 5 piece loose samples |

**Optimum Technology Matching® Applied**

- |  |                                      |                                     |                                   |
|--|--------------------------------------|-------------------------------------|-----------------------------------|
| <input checked="" type="checkbox"/> GaAs HBT | <input type="checkbox"/> SiGe BiCMOS | <input type="checkbox"/> GaAs pHEMT | <input type="checkbox"/> GaN HEMT |
| <input type="checkbox"/> GaAs MESFET         | <input type="checkbox"/> Si BiCMOS   | <input type="checkbox"/> Si CMOS    |                                   |
| <input type="checkbox"/> InGaP HBT           | <input type="checkbox"/> SiGe HBT    | <input type="checkbox"/> Si BJT     |                                   |

RF MICRO DEVICES®, RFMD®, Optimum Technology Matching®, Enabling Wireless Connectivity™, PowerStar®, POLARIS™ TOTAL RADIO™ and UltimateBlue™ are trademarks of RFMD, LLC. BLUETOOTH is a trademark owned by Bluetooth SIG, Inc., U.S.A. and licensed for use by RFMD. All other trade names, trademarks and registered trademarks are the property of their respective owners. ©2006, RF Micro Devices, Inc.

## Absolute Maximum Ratings

| Parameter                      | Rating        | Unit            |
|--------------------------------|---------------|-----------------|
| Supply Voltage                 | -0.5 to +6.0  | V <sub>DC</sub> |
| Input RF Level                 | +5 (see note) | dBm             |
| Current Drain, I <sub>CC</sub> | 32            | mA              |
| Operating Ambient Temperature  | -40 to +85    | °C              |
| Storage Temperature            | -40 to +150   | °C              |

NOTE: Exceeding any one or a combination of the above maximum rating limits may cause permanent damage. Input RF transients to +15dBm will not harm the device. For sustained operation at inputs  $\geq +5$ dBm, a small dropping resistor is recommended in series with the V<sub>CC</sub> in order to limit the current due to self-biasing to <32mA.



Caution! ESD sensitive device.

Exceeding any one or a combination of the Absolute Maximum Rating conditions may cause permanent damage to the device. Extended application of Absolute Maximum Rating conditions to the device may reduce device reliability. Specified typical performance or functional operation of the device under Absolute Maximum Rating conditions is not implied.

RoHS status based on EU Directive 2002/95/EC (at time of this document revision).

The information in this publication is believed to be accurate and reliable. However, no responsibility is assumed by RF Micro Devices, Inc. ("RFMD") for its use, nor for any infringement of patents, or other rights of third parties, resulting from its use. No license is granted by implication or otherwise under any patent or patent rights of RFMD. RFMD reserves the right to change component circuitry, recommended application circuitry and specifications at any time without prior notice.

| Parameter                                   | Specification |       |      | Unit | Condition   |
|---|---------------|-------|------|------|---|
|   | Min.          | Typ.  | Max. |      |   |
| <b>Operating Range</b>                      |               |       |      |      | T <sub>AMB</sub> = +25 °C, V <sub>CC</sub> = 3.0V   |
| Frequency Range                             | 900           |       | 4000 | MHz  |   |
| <b>WiBRO/WLAN/WiMAX Low Noise Amplifier</b> |               |       |      |      |   |
| Frequency                                   | 2300          |       | 2700 | MHz  |   |
| <b>HIGH GAIN MODE</b>                       |               |       |      |      | Gain Select < 0.8V, V <sub>BIAS</sub> = 3V, T = +25 °C                                      |
| Gain  | 12.0          | 14.0  |      | dB   |   |
| Noise Figure                                |               | 1.3   | 1.5  | dB   |   |
| Input IP3                                   |               | +8    |      | dBm  | IIP3 will improve if ICC is raised above 7 mA.  |
| Output VSWR                                 |               | 1.7:1 | 2:1  |      |   |
| Current Drain                               |               | 7     |      | mA   | Current Drain = I <sub>CC</sub> + I <sub>REF</sub>  |
| <b>BYPASS MODE</b>                          |               |       |      |      | Gain Select > 1.8V, V <sub>BIAS</sub> = 0V  |
| Gain  | -4.0          | -3.0  | -2.0 | dB   | Note: Bypass mode insertion loss will degrade gradually as V <sub>CC</sub> goes below 2.7V. |
| Input IP3                                   | +18.0         | +20.0 |      | dBm  |   |
| Output VSWR                                 |               | 1.6:1 |      |      |   |
| Current Drain                               |               | 2.9   | 3.0  | mA   | Current Drain = I <sub>CC</sub> + I <sub>REF</sub>  |
| <b>WiMAX Low Noise Amplifier</b>            |               |       |      |      |   |
| Frequency                                   | 3100          | 3500  | 3800 | MHz  |   |
| Gain  |               | 11    |      | dB   | Gain Select < 0.8V, V <sub>BIAS</sub> = 3V  |
| Noise Figure                                |               | 1.6   |      | dB   |   |
| Input IP3                                   | +14           |       |      | dBm  |   |
| <b>BYPASS MODE (Low Gain)</b>               |               |       |      |      | Gain Select > 1.8V, V <sub>BIAS</sub> = 0V  |
| Gain  |               | -4    |      | dBm  |   |
| Input IP3                                   | +18           |       |      | dBm  |   |
| <b>GPS Low Noise Amplifier</b>              |               |       |      |      |   |
| Frequency                                   | 1500          | 1575  | 1600 | MHz  |   |
| Gain  |               | 17    |      | dB   | Gain Select < 0.8V, V <sub>BIAS</sub> = 3V  |
| Noise Figure                                |               | 1.2   |      | dB   |   |
| Input IP3                                   |               | +6    |      | dBm  |   |

| Parameter              | Specification |      |      | Unit    | Condition   |
|------------------------|---------------|------|------|---------|---|
|                        | Min.          | Typ. | Max. |         |   |
| BYPASS MODE (Low Gain) |               |      |      |         | Gain Select > 1.8V, $V_{BIAS} = 0V$                   |
| Gain                   | -4            | -3   |      | dBm     |   |
| Input IP3              | +20           |      |      | dBm     |   |
| <b>Power Supply</b>    |               |      |      |         |   |
| Voltage ( $V_{CC}$ )   |               | 3    |      | V       |   |
| $V_{SELECT}$ Low       |               |      | 0.8  | V       | High Gain mode.<br>Select < 0.8V, $V_{BIAS} = 3V$     |
| $V_{SELECT}$ High      | 1.8           |      |      | V       | Low Gain mode.<br>Select > 1.8V, $V_{BIAS} = 0V$      |
| Power Down             | 0             |      | 10   | $\mu A$ | Gain Select < 0.8V, $V_{BIAS} = 0V$ , $V_{CC} = 3.0V$ |

Bias note: Due to the presence of ESD protection circuitry on the RF2370, the maximum allowable collector bias voltage (pin 4) is 4.0V. Higher supply voltages such as 5V are permissible if a series resistor is used to drop  $V_{CC}$  to  $\leq 4.0V$  for a given  $I_{CC}$ .

Bias note 2: In bypass mode,  $V_{REF}$  is essentially a “don’t care” condition. Pulling  $V_{REF}$  low when in bypass mode does conserve the small 1mA to 2mA supplied by  $V_{REF}$ .

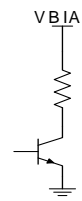
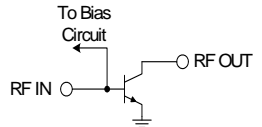
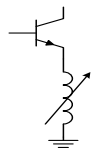
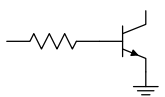
| Pin | Function           | Description   | Interface Schematic   |
|-----|--------------------|---|---|
| 1   | <b>BIAS</b>        | For low noise amplifier applications, this pin is used to control the bias current. An external resistor can be used to set the bias current for any $V_{BIAS}$ voltage.  |    |
| 2   | <b>GND1</b>        | Ground connection. For best performance, keep traces physically short and connect immediately to ground plane.  |   |
| 3   | <b>RF IN</b>       | RF input pin. This part is designed such that $50\Omega$ is the optimal source impedance for best noise figure. Best noise figure is achieved with only a series capacitor on the input.  |    |
| 4   | <b>RF OUT</b>      | Amplifier output pin. This pin is an open-collector output. It must be biased to $V_{CC}$ through a choke or matching inductor. This pin is matched to $50\Omega$ with a shunt L, series L topology enhances to stability of the device by reducing the high frequency gain above 6GHz. |   |
| 5   | <b>GND2</b>        | See GND1.   |    |
| 6   | <b>GAIN SELECT</b> | This pin selects high gain and bypass modes.<br>Gain Select $\leq 0.8V$ , high gain.<br>Gain Select $\geq 1.8V$ , low gain.<br>A series resistor of $100\Omega$ is required on this pin to enhance stability.   |  |

Package Drawing

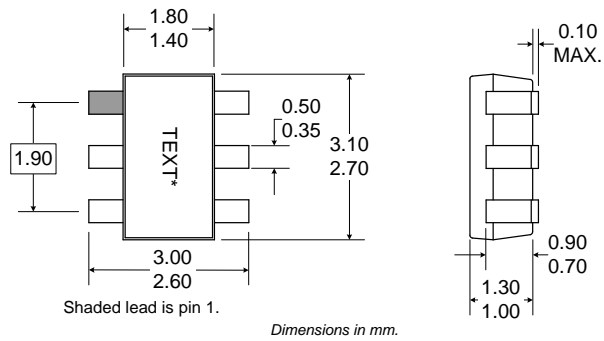

Shaded lead is pin 1.

Dimensions in mm.

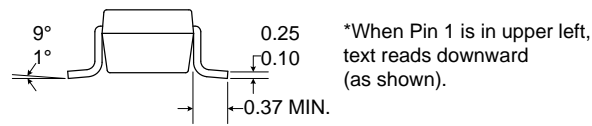

\*When Pin 1 is in upper left, text reads downward (as shown).

## Evaluation Board Schematic WiBRO/WLAN/WiMAX Schematic (2.3GHz to 2.7GHz)

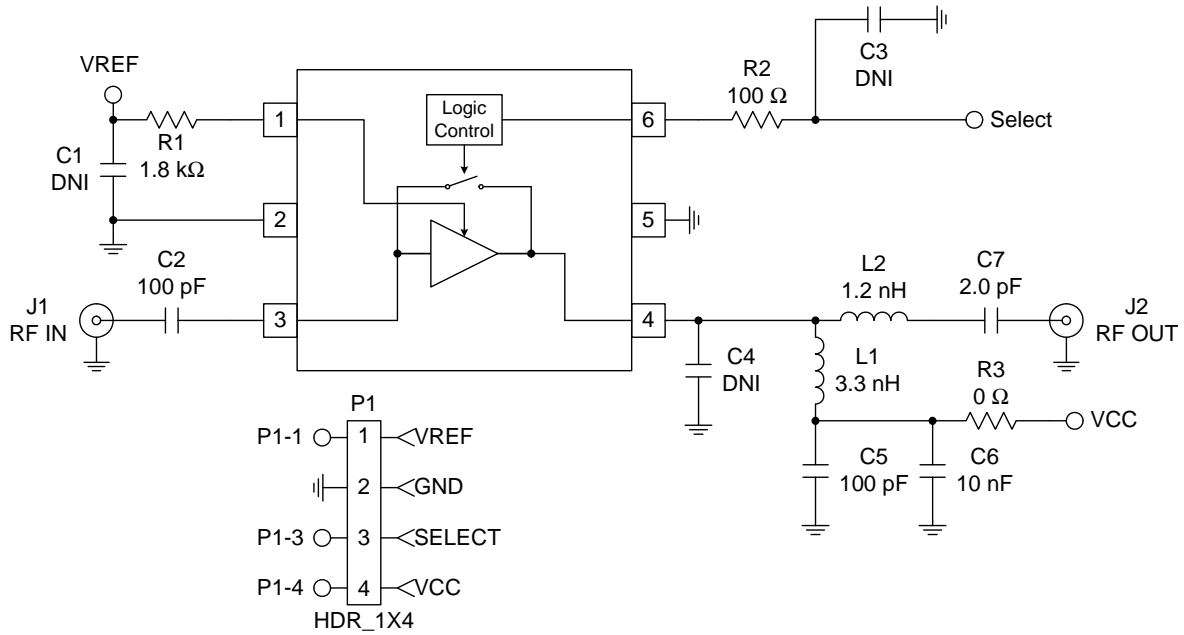

## GPS Schematic (1.5GHz to 1.6GHz)

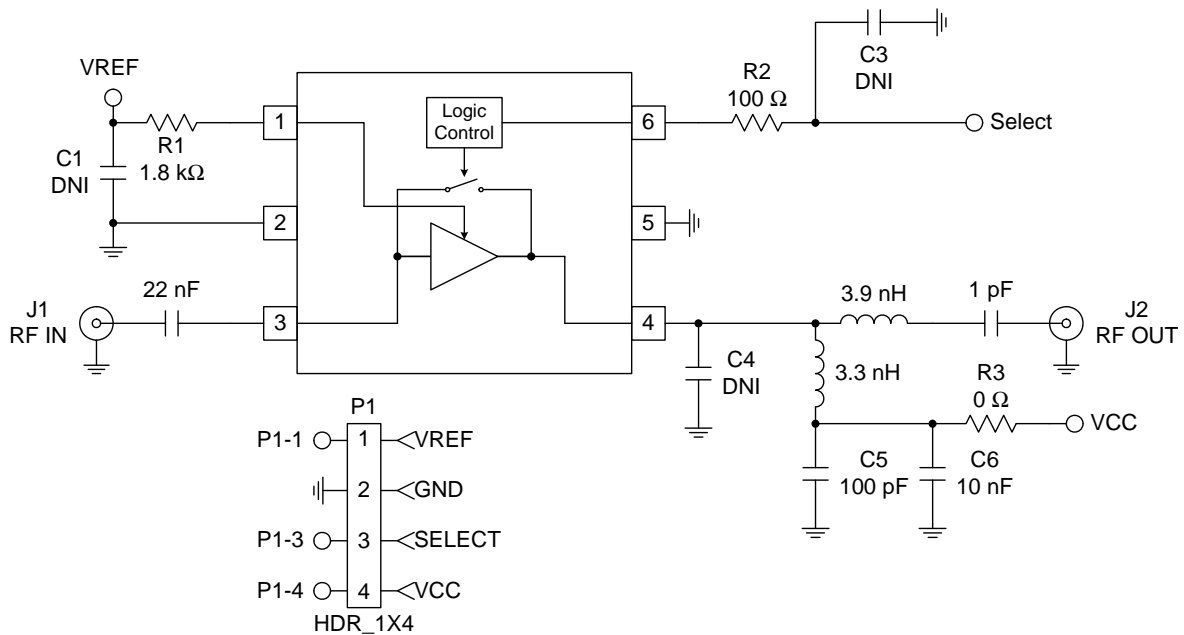

**Evaluation Board Layout**  
**Board Size 0.835" x 0.900"**  
**Board Thickness 0.032", Board Material FR-4**

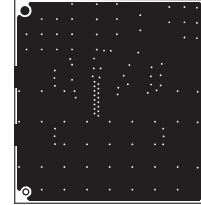
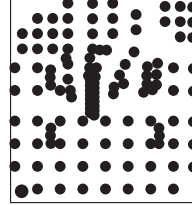
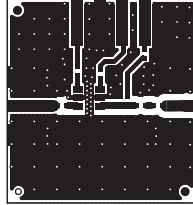
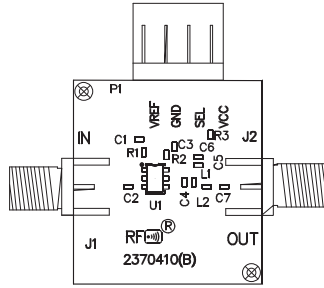

## WiBRO/WLAN/WiMAX DATA

**Gain @ WLAN Band in High Gain Mode**  
 $V_{CC}=3.0V$  and  $V_{REF}=3.0V$  Over Temp

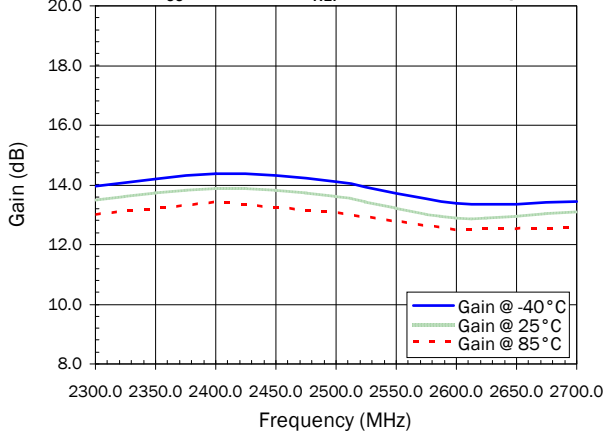

**Gain @ WLAN Band in Bypass Mode**  
 $V_{CC}=3.0V$  and  $V_{REF}=3.0V$  Over Temp

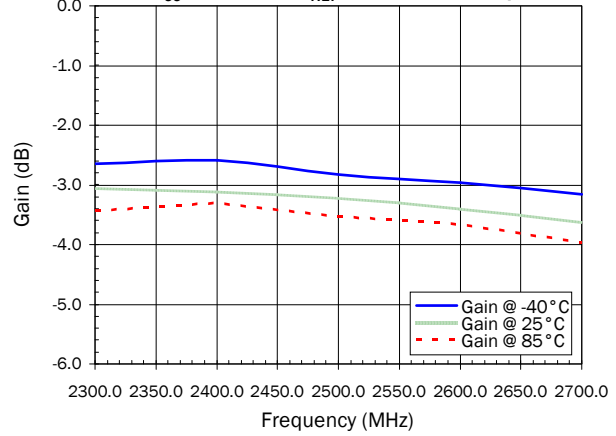

**Noise Figure @ WLAN Band in High Gain Mode**  
 $V_{CC}=3.0V$  and  $V_{REF}=3.0V$  Over Temp

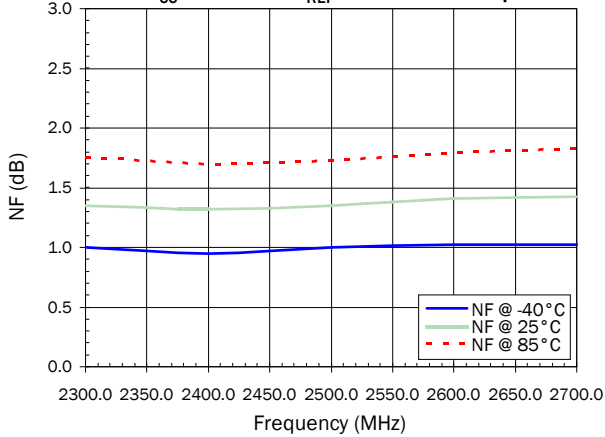

**IIP3 @ WLAN Band in High Gain Mode**  
 $V_{CC}=3.0V$  and  $V_{REF}=3.0V$  Over Temp

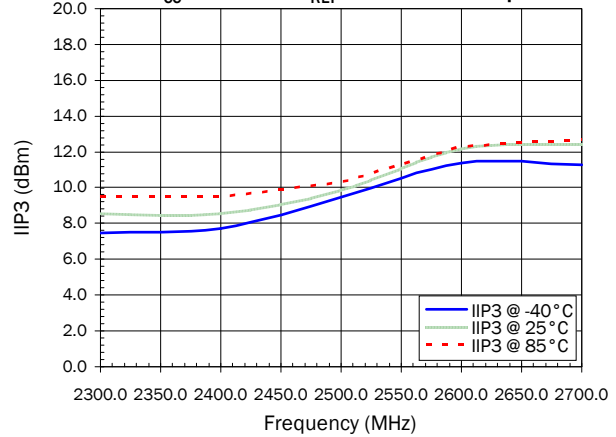

**IIP3 @ WLAN Band in Bypass Mode**  
 $V_{CC}=3.0V$  and  $V_{REF}=3.0V$  Over Temp

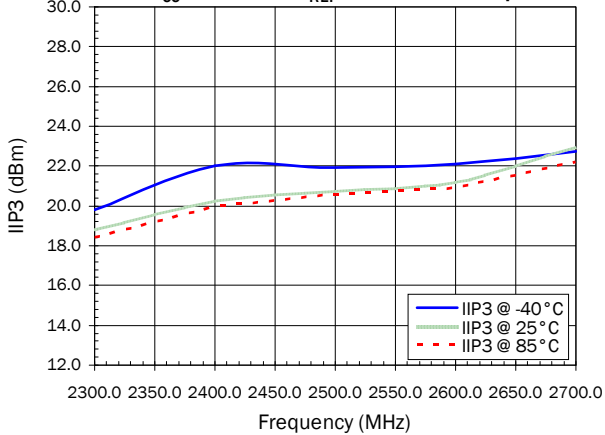

**$I_{CC} + I_{REF}$  @ WLAN Band in High Gain Mode**  
 $V_{CC}=3.0V$  and  $V_{REF}=3.0V$  Over Temp

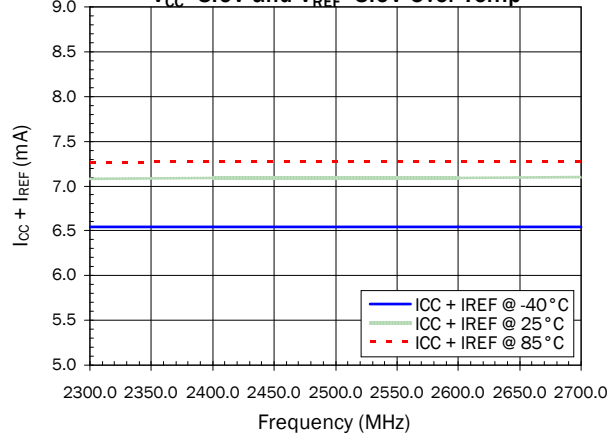



**WiMAX Data**

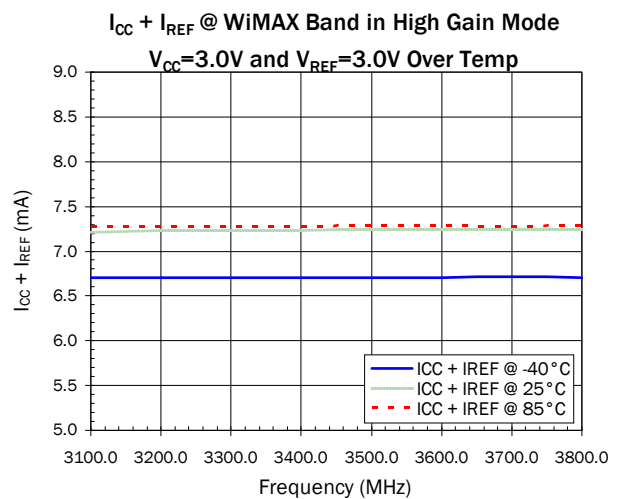
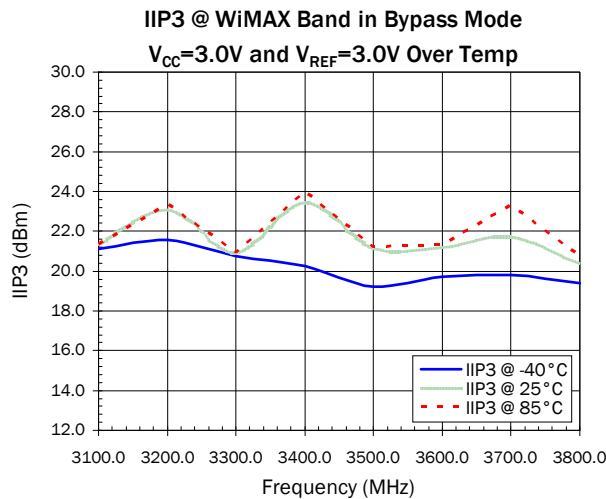
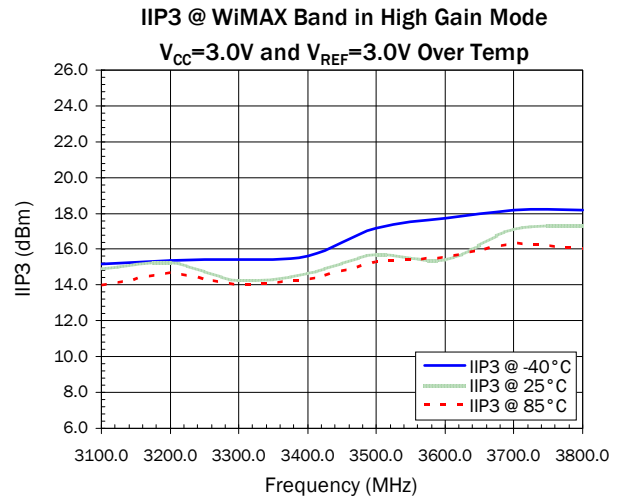
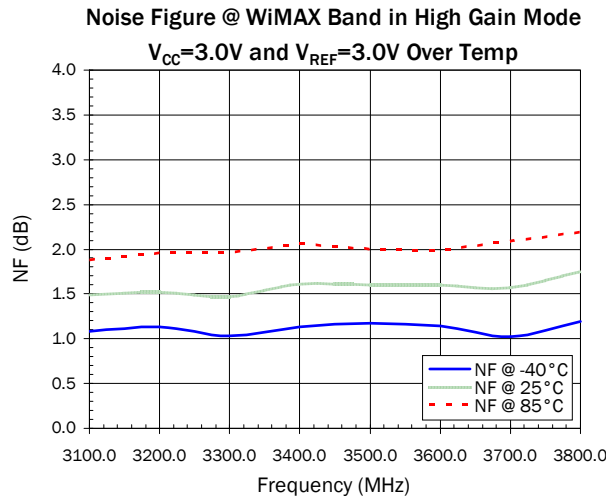
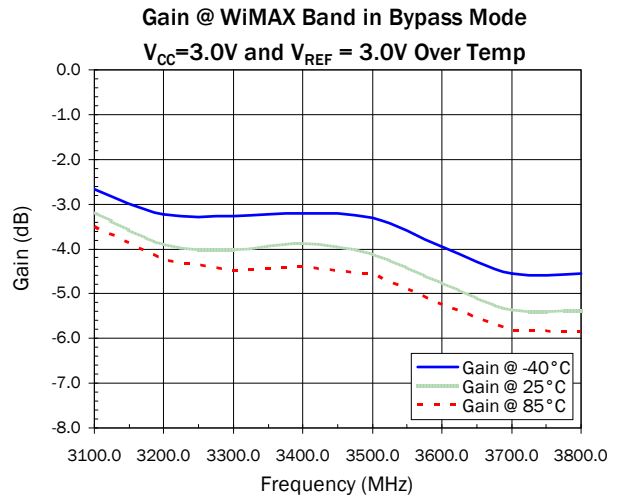
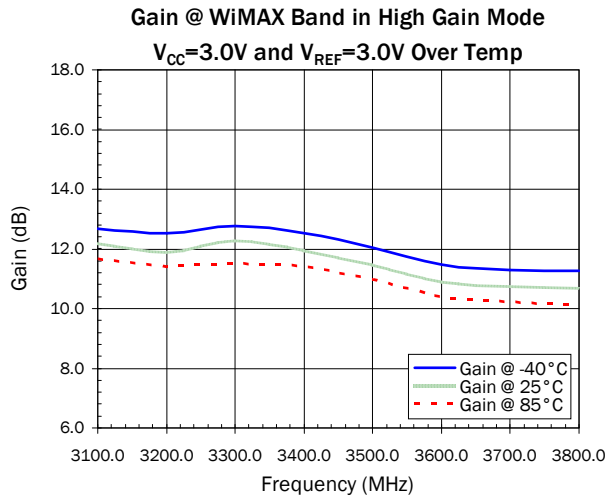

## GPS Data

**Gain @ GPS Band in High Gain Mode**  
 $V_{CC}=3.0V$  and  $V_{REF}=3.0V$  Over Temp

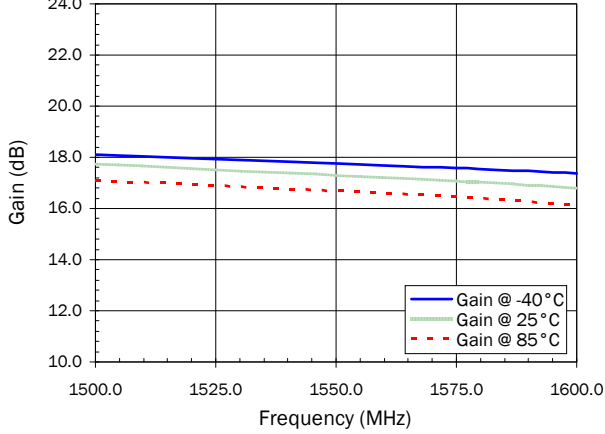

**Gain @ GPS Band in Bypass Mode**  
 $V_{CC}=3.0V$  and  $V_{REF}=3.0V$  Over Temp

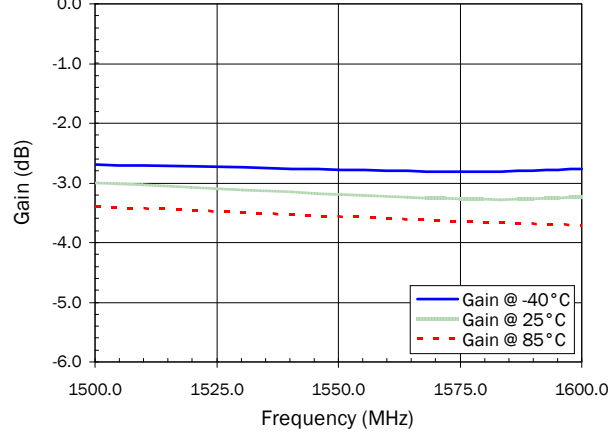

**Noise Figure @ GPS Band in High Gain Mode**  
 $V_{CC}=3.0V$  and  $V_{REF}=3.0V$  Over Temp

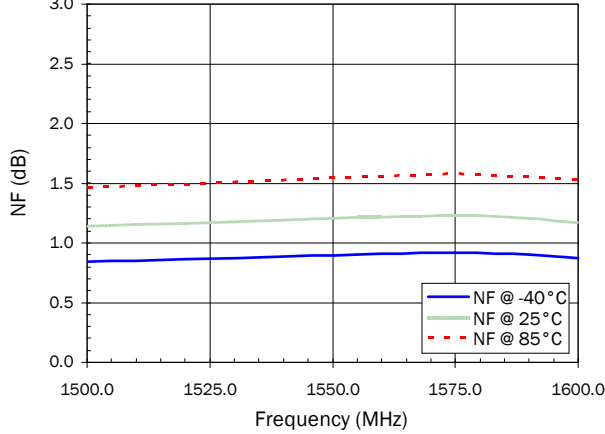

**IIP3 @ GPS Band in High Gain Mode**  
 $V_{CC}=3.0V$  and  $V_{REF}=3.0V$  Over Temp

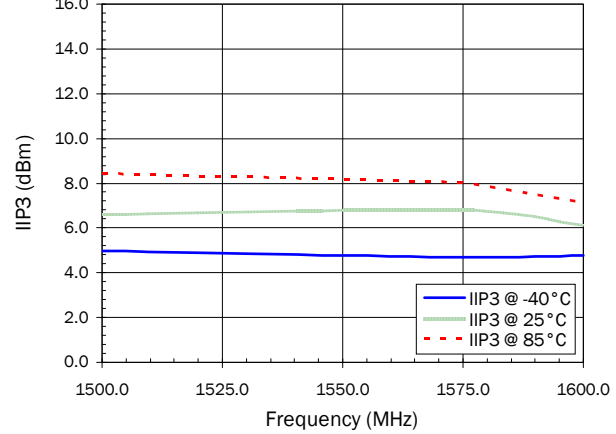

**IIP3 @ GPS Band in Bypass Mode**  
 $V_{CC}=3.0V$  and  $V_{REF}=3.0V$  Over Temp

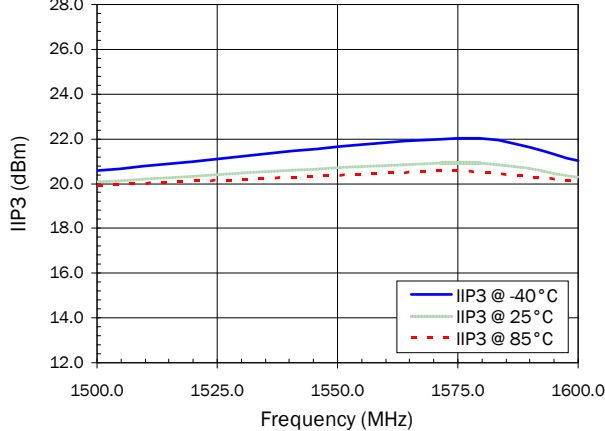

**$I_{CC} + I_{REF}$  @ GPS Band in High Gain Mode**  
 $V_{CC}=3.0V$  and  $V_{REF}=3.0V$  Over Temp

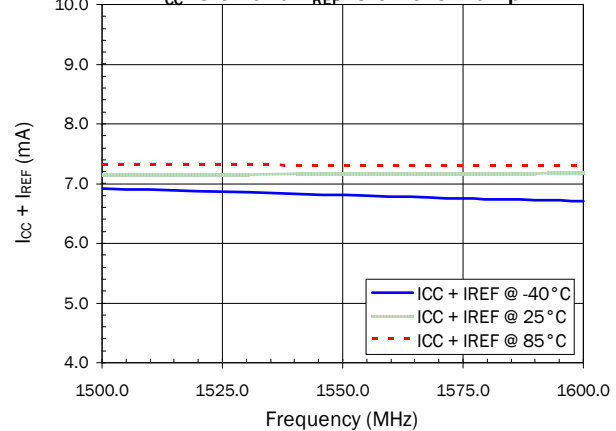

**RoHS\* Banned Material Content**

RoHS Compliant: Yes  
 Package total weight in grams (g): 0.013  
 Compliance Date Code: N/A  
 Bill of Materials Revision: -  
 Pb Free Category: e3

| Bill of Materials | Parts Per Million (PPM) |    |    |       |     |      |
|-------------------|-------------------------|----|----|-------|-----|------|
|                   | Pb                      | Cd | Hg | Cr VI | PBB | PBDE |
| Die               | 0                       | 0  | 0  | 0     | 0   | 0    |
| Molding Compound  | 0                       | 0  | 0  | 0     | 0   | 0    |
| Lead Frame        | 0                       | 0  | 0  | 0     | 0   | 0    |
| Die Attach Epoxy  | 0                       | 0  | 0  | 0     | 0   | 0    |
| Wire              | 0                       | 0  | 0  | 0     | 0   | 0    |
| Solder Plating    | 0                       | 0  | 0  | 0     | 0   | 0    |

**This RoHS banned material content declaration was prepared solely on information, including analytical data, provided to RFMD by its suppliers, and applies to the Bill of Materials (BOM) revision noted**

\* DIRECTIVE 2002/95/EC OF THE EUROPEAN PARLIAMENT AND OF THE COUNCIL of 27 January 2003 on the restriction of the use of certain hazardous substances in electrical and electronic equipment